



**BLUE OX**

# BX1126 2007-14 Jeep Wrangler/Wrangler Unlimited Installation Instructions

**Attachment Tab Height: 14-1/2"**

**Attachment Tab Width: 24"**

**Serial Number**

**Please read BOTH these Installation Instructions and the General Instructions prior to installing or operating this equipment.**

- Blue Ox® towing products and accessories are intended to be installed by Blue Ox® Dealers who are familiar with our products and have the equipment and knowledge necessary to do "fit work". If needed, Blue Ox® Dealers can be found at [www.blueox.com](http://www.blueox.com) or by contacting our Customer Care Department at (402) 385-3051.
- Many Blue Ox® baseplates are designed to use existing holes and hardware to mount the baseplate to the towed vehicle. Even though bolts are there, do not assume they are adequate for baseplate mounting. Always use the hardware supplied in the hardware kit and existing hardware as specified in the installation instructions.

### Bolt Torque Specifications

Torque in Foot-Pounds for Inch Bolts

Bolt Size	Grade 5	Grade 8
1/4"	10	14
5/16"	19	29
3/8"	33	47
7/16"	54	78
1/2"	78	119
5/8"	154	230
3/4"	257	380



### Bolt Torque Specifications

Torque in Foot-Pounds for Metric Bolts

Bolt Size	Grade 8.8	Grade 10.9
6MM	6	8
8MM	16	22
10MM	31	40
12MM	54	70
14MM	89	117
16MM	161	230
18MM	222	318

If the front of your vehicle looks different than this, please contact us at (402)385-3051.

**Reference your vehicle owner's manual for manufacturer's towing specifications.**



# WARNING

Failure to read and follow these instructions could result in separation of the towed vehicle from the tow bar, causing property damage, loss of towed vehicle, personal injury or death.

BX1126  
2007-14 Jeep Wrangler/Wrangler Unlimited  
Installation Instructions

**Attachment Tabs:** Due to the design of the removable tabs, the RangeFinder II tow bar can not be used. Adapters, except the BX8833 and BX88151, can not be used with this baseplate.

**Instruction Notes:** The belly pan and metal bumper are removed and reinstalled for the baseplate installation. Some drilling and trimming is required.

Place all components that are removed on a flat, sturdy surface. All items will be reinstalled unless otherwise noted after the baseplate is installed.

The dimensional variations between otherwise identical vehicles can be considerable. While the baseplate was designed for easy installation, it may be necessary to tailor the baseplate slightly to compensate for vehicle manufacturer's tolerances.

The BX8869 Tail Light Wiring Kit is recommended for this vehicle.



Drill a hole according to the tail  
light wiring kit instructions.

### **NOTICE**

- Handling of some cosmetic parts when installing this product may require the use of protective covers, rags, specialty tools, etc. to prevent damage.
- When using power drills be aware of the dangers of torque and drill bit length.
- When using a reciprocating saw be aware of objects behind the cutting surface.
- Use a good quality paint to spray cut edges of frame to prevent rusting.
- Be sure that **ALL** electrical connections are plugged in and accessories are functioning properly before reinstalling the fascia.
- The baseplate is computer tested to your vehicle's GVWR, exceeding this weight will void the manufacturer's warranty.
- Be sure to use Loctite® Red on all bolts before tightening. Tighten all bolts according to the torque chart provided.
- Dealer or installer be certain the user receives these instruction sheet.
- If the baseplate is in an accident, it must be replaced. **DO NOT** use it again! An accident can cause unseen damage and using it again could result in more damage or serious injury. **DO NOT** use the baseplate if it is damaged or missing parts.

# BX1126

## 2007-14 Jeep Wrangler/Wrangler Unlimited

### Installation Instructions

#### **Tools Required**

Large Vise Grip  
 Utility Knife  
 Phillips Screwdriver  
 Torque Wrench  
 Drill  
 Reciprocating Saw  
 Tape Measure  
 Loctite® RED  
 17/32" Drill Bit  
 18MM Socket  
 3/4" Socket  
 15/16" Socket

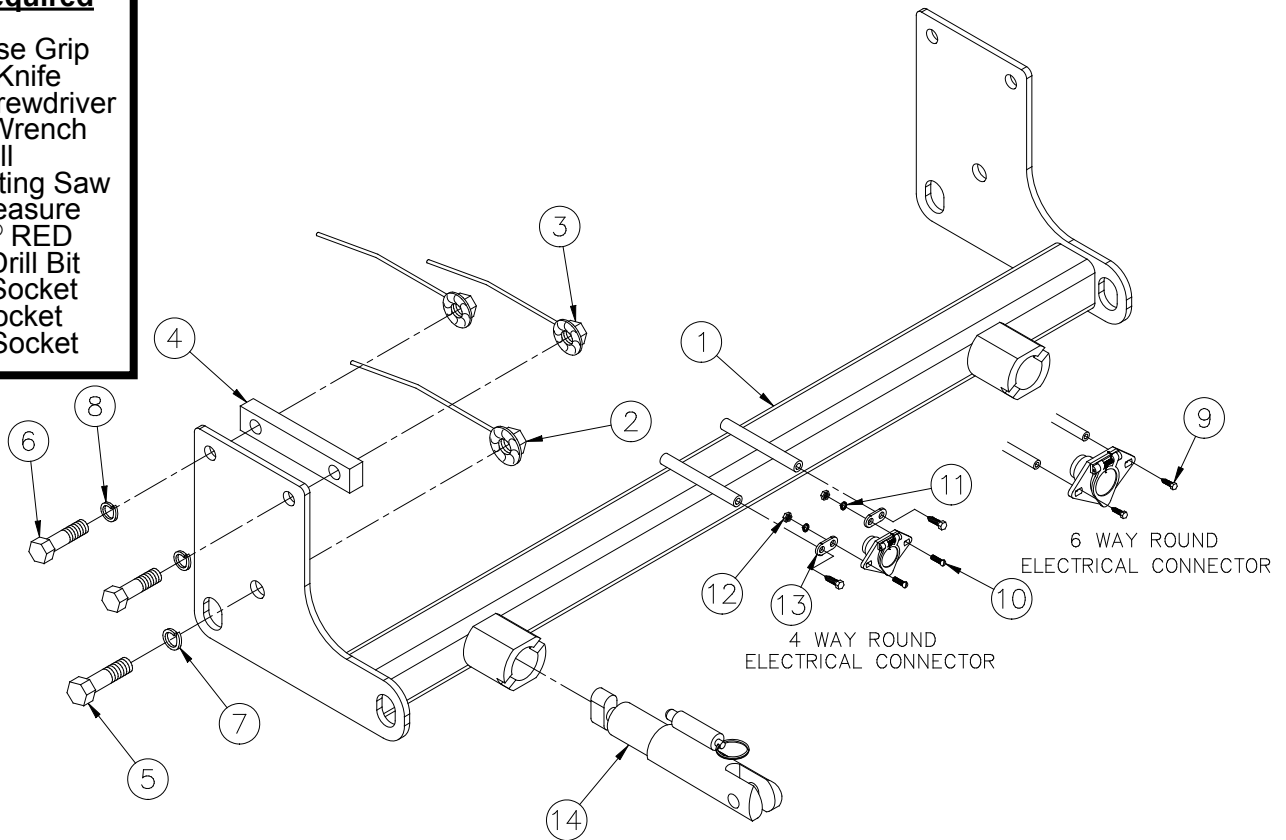

Item No.	Part No.	Description	Qty.
1.....	61-6344 .....	BX1126 Baseplate .....	1
2.....	61-3997 .....	5/8"-11 Nut Wire .....	2
3.....	61-4029 .....	1/2"-13 Whiz Nut w/14" Wire .....	4
4.....	102-6768 .....	BX1126 Spacer Plate .....	2
5.....	201-0350 .....	5/8"-11 x 1-1/2" Hex Head Bolt, Grade 5, ZP .....	2
6.....	201-0068 .....	1/2"-13 x 1-3/4" Hex Head Bolt, Grade 5, ZP .....	4
7.....	203-0013 .....	5/8" Lock Washer, ZP .....	2
8.....	203-0012 .....	1/2" Lock Washer, ZP .....	4
9.....	201-0553 .....	1/4"-20 x 1/2" Hex Wshd, Type F Screw.....	2
10.....	201-0192 .....	#10-32 x 1/2" Round Head Slot Screw.....	2
11.....	203-0054 .....	#10 Lock Washer.....	2
12.....	202-0047 .....	#10-32 Hex Nut .....	2
13.....	101-5822 .....	4-Way Connector Adapter .....	2
14.....	62-3468 .....	Attachment Tab Assembly, SF/SB (R).....	2
15.....	226-0046(not shown) .....	Class III Safety Cables .....	2
16.....	229-0359(not shown) .....	3/8" Quicklink, ZP .....	2
17.....	290-0437(not shown) .....	Black Cap Plug Receiver.....	2

#### **Important:**

Use only genuine factory replacement parts on your baseplate. Do NOT substitute homemade or non-typical parts. If a bolt is lost or in need of replacement, for your safety and the preservation of your baseplate, be sure to use a replacement bolt of the same grade (In most cases it will be Grade 5, please reference the parts list above). Replacement parts may be ordered through your nearest Blue Ox® Dealer or Distributor. Failing to follow and/or altering these installation instructions in either installation or required equipment will void the manufacturer's warranty.

BX1126  
2007-14 Jeep Wrangler/Wrangler Unlimited  
Installation Instructions

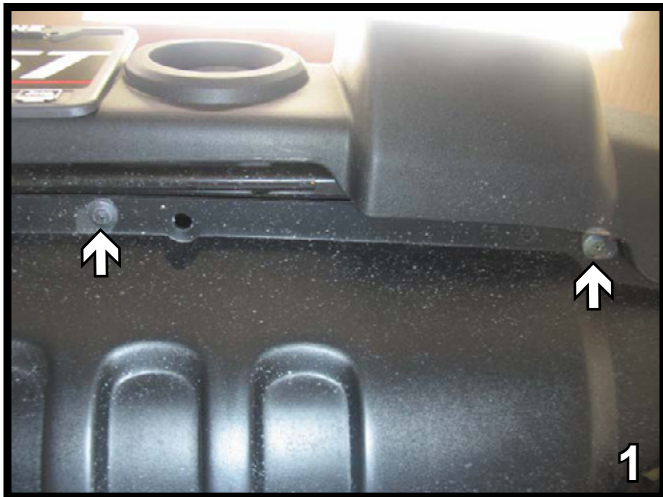

1. Using a Phillips screwdriver, remove the four (4) push pins from the bottom of the belly pan. There are two (2) on each side.

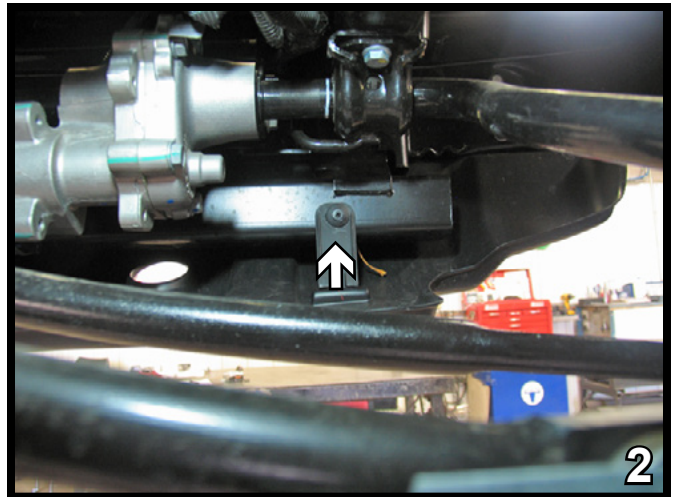

2. Using a Phillips screwdriver, remove the two (2) push pins from tabs on the backside of the belly pan. Set the belly pan aside.

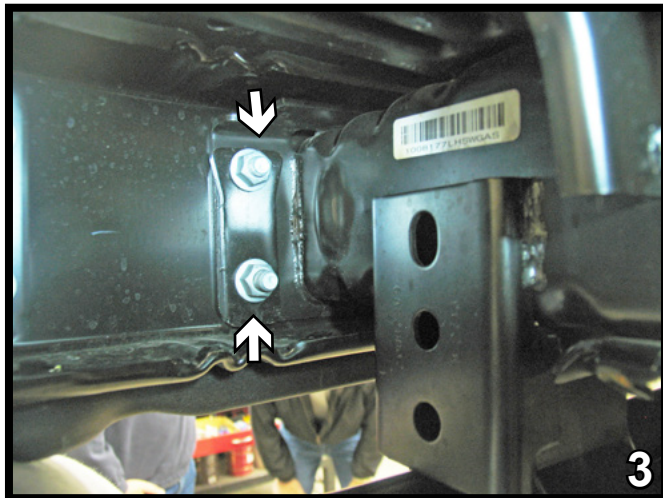

3. Disconnect foglights from back side of metal bumper. Using the 18mm socket, remove the two (2) metric bolts on outside edge of frame. Do this on both sides of the vehicle.

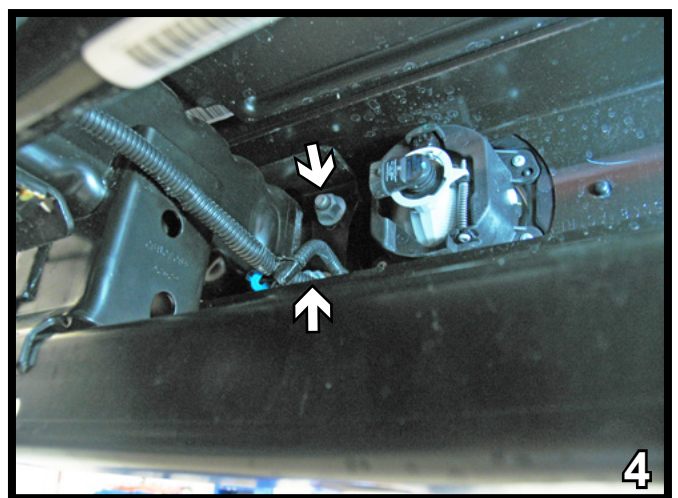

4. Using the 18mm socket, remove the two (2) metric bolts on inside edge of frame. Do this on both sides of the the vehicle.



BX1126  
2007-14 Jeep Wrangler/Wrangler Unlimited  
Installation Instructions

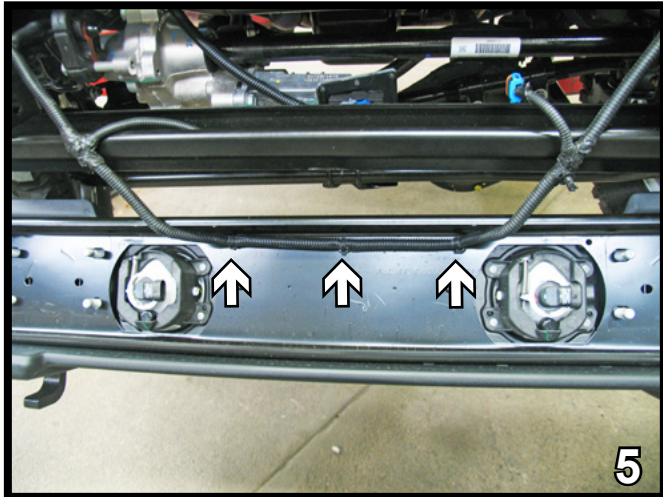

5. Pull the bumper forward and disconnect clips from the wiring loom running along the backside of the bumper. Set the bumper aside.

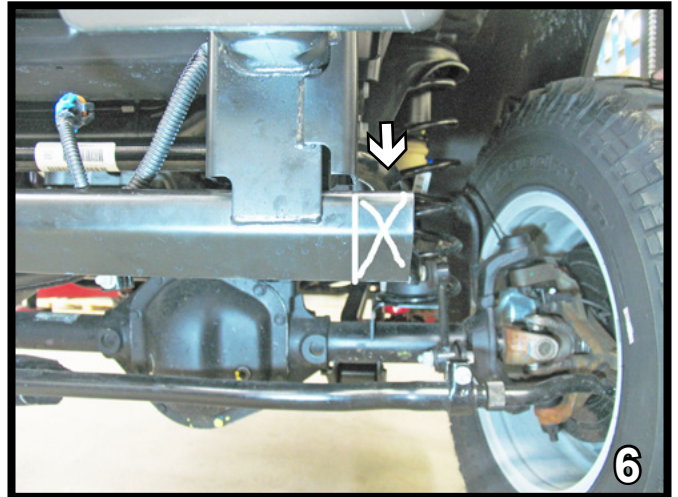

6. **On the 2007-09 models:** Using the reciprocating saw, cut the lower frame extension flush with the outside edge of the lower side bracket. Do this to both sides of the vehicle. We recommend painting the cut edges to prevent them from rusting.

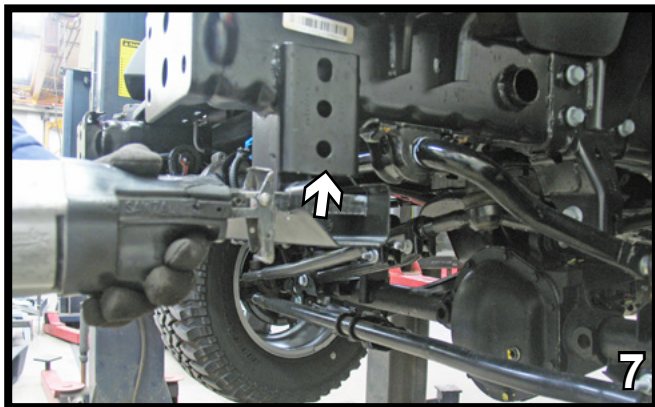

7. **On the 2007-09 models:** Align the baseplate's lower hole with the existing lower hole in the frame, insure baseplate is level with frame and clamp in place with the vice grips. Do this to both sides of the vehicle.

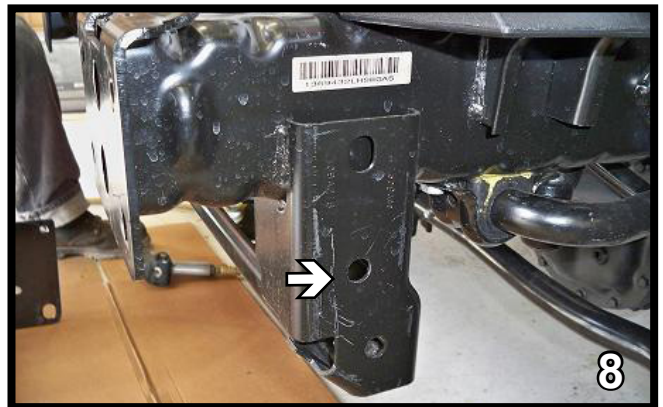

8. **On the 2010 model and newer:** Align the baseplate's lower hole with the existing middle hole in the frame, insure baseplate is level with frame and clamp in place with the vice grips. Do this to both sides of the vehicle.

BX1126  
2007-14 Jeep Wrangler/Wrangler Unlimited  
Installation Instructions

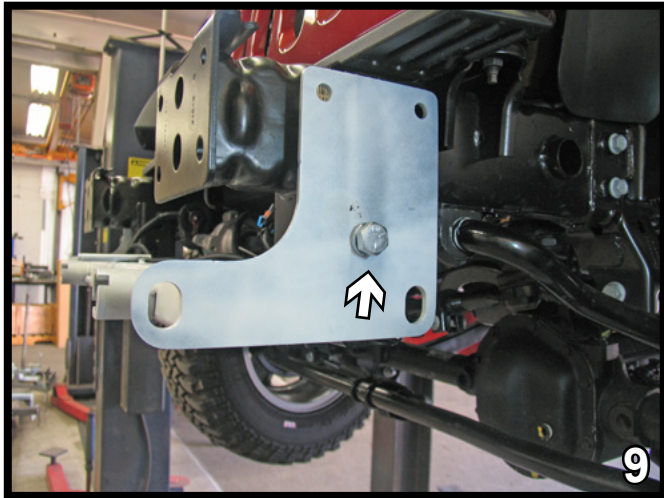

9. Insert the 5/8"-11 whiz nut into the frame end and align with the lower hole on the 2007-09s and the middle hole on the 2010s and newer. Install the 5/8"-11 x 1-1/2" hex bolt and 5/8" lock washer and tighten to whiz nut. Do this on both sides of the vehicle.

11. Reinstall the bumper and wiring loom.  
Re-connect the foglights.

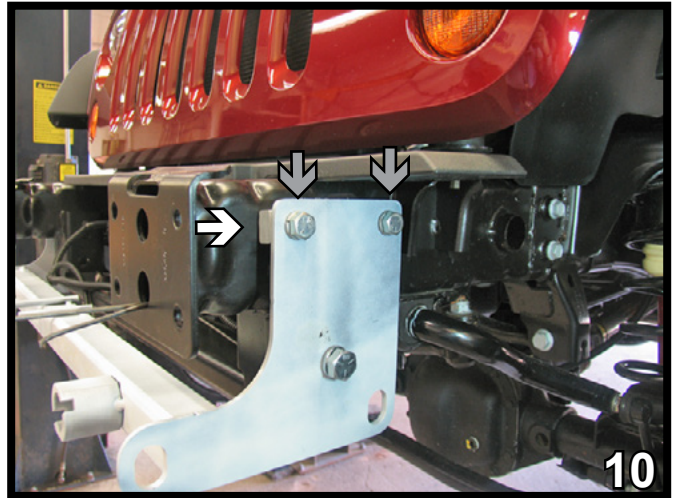

10. Using a 17/32" drill bit, drill the top holes of the baseplate thru the frame. Install the spacer plate in between the baseplate and frame (white). Install 1/2"-13 x 1-3/4" bolts with 1/2" lock washers thru the baseplate, spacer and frame (gray). Insert 1/2" whiz nuts with wires on the inside of the frame. Do this on both sides of the vehicle.



12. Attach the permanent baseplate safety cables to the provided convenience link on the baseplate (gray arrow). The photo above shows the recommended installation of the cables to frame of vehicle (white arrow). Additional options may interfere with suggested mounting; in this case secure the cables to a solid piece of the frame as described in the instructions included with the permanent baseplate safety cables. Be sure the safety cables do not rub against any hoses or moving parts. Do this to both sides of the vehicle.



13. Hold the belly pan up to its original position, mark and trim a slot for baseplate endplate to come through with the utility knife. Do this to both sides of the vehicle. Slide the belly pan between baseplate crosstube and lower frame suspension. Allow endplate to come through slot and reinstall the belly pan to its original location.



BX1126  
2007-14 Jeep Wrangler/Wrangler Unlimited  
Installation Instructions

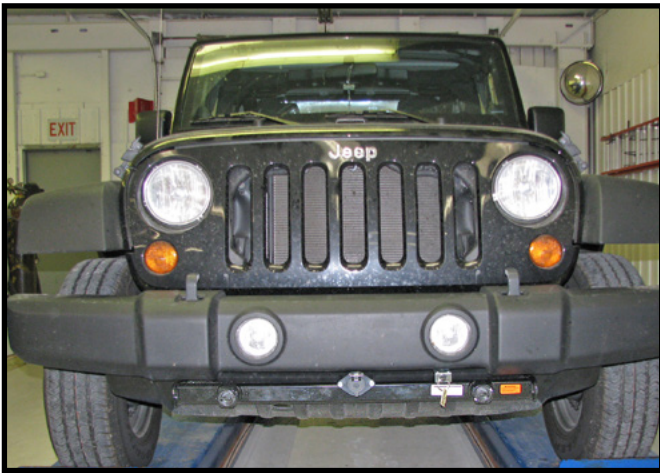

**Shown without removable tabs installed**



**Shown with removable tabs installed**

## **CUSTOMER SERVICE COMMITMENT**

Blue Ox® is committed to providing you with exceptional customer care throughout your lifetime with our products. Our team is here to assist you with any questions you may have regarding the performance of your product. Simply call (402) 385-3051 and you can speak with our customer care team.

Additionally, please visit our website to see which rallies our Destination America team will be attending. For a nominal fee, our service technician will service your towing system to ensure it's in proper working condition. Also, as a commitment to our customers, should you visit our factory, you can stay at our full service Blue Ox® campground at no charge along with enjoying a factory tour.

Again, thank you for being our customer and for the confidence you have shown in the performance of our products. It is because of customers like you we enjoy the success we have today.

© 2013 Blue Ox  
One Mill Road, Industrial Park  
Pender, Nebraska 68047  
Phone: (402) 385-3051  
Fax: (402) 385-3360  
[www.blueox.com](http://www.blueox.com)