



BX1989

2003-14 Dodge Ram 2500 2003-14 Dodge Ram 3500 Installation Instructions

Serial Number

Attachment Tab Height: 25-1/2"

Attachment Tab Width: 24"

Please read BOTH these Installation Instructions and the General Instructions prior to installing or operating this equipment.

- Blue Ox® towing products and accessories are intended to be installed by Blue Ox® Dealers who are familiar with our products and have the equipment and knowledge necessary to do "fit work". If needed, Blue Ox® Dealers can be found at www.blueox.com or by contacting our Customer Care Department at (402) 385-3051.
- Many Blue Ox® baseplates are designed to use existing holes and hardware to mount the baseplate to the towed vehicle. Even though bolts are there, do not assume they are adequate for baseplate mounting. Always use the hardware supplied in the hardware kit and existing hardware as specified in the installation instructions.

Bolt Torque Specifications
Torque in Foot-Pounds for Inch Bolts

Bolt Size	Grade 5	Grade 8
1/4"	10	14
5/16"	19	29
3/8"	33	47
7/16"	54	78
1/2"	78	119
5/8"	154	230
3/4"	257	380



Bolt Torque Specifications
Torque in Foot-Pounds for Metric Bolts

Bolt Size	Grade 8.8	Grade 10.9
6MM	6	8
8MM	16	22
10MM	31	40
12MM	54	70
14MM	89	117
16MM	161	230
18MM	222	318

If the front of your vehicle looks different than this, please contact us at (402)385-3051.

Reference your vehicle owner's manual for manufacturer's towing specifications.

⚠ WARNING

Failure to read and follow these instructions could result in separation of the towed vehicle from the tow bar, causing property damage, loss of towed vehicle, personal injury or death.

BX1989
2003-14 Dodge Ram 2500
2003-14 Dodge Ram 3500
Installation Instructions

Instruction Notes: The bumper is removed and reinstalled for the baseplate installation.

Place all components that are removed on a flat, sturdy surface. All items will be reinstalled unless otherwise noted after the baseplate is installed.

The dimensional variations between otherwise identical vehicles can be considerable. While the baseplate was designed for easy installation, it may be necessary to tailor the baseplate slightly to compensate for vehicle manufacturer's tolerances.

The BX8869 Tail Light Wiring Kit is recommended for Non-LED tail light models.
The BX8848 4-Diode Wiring Kit is recommended for models with LED tail lights.

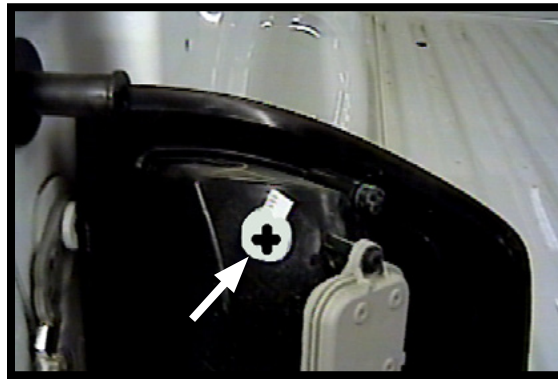

Drill a hole according to the tail light wiring kit instructions.

NOTICE

- Handling of some cosmetic parts when installing this product may require the use of protective covers, rags, specialty tools, etc. to prevent damage.
- When using power drills be aware of the dangers of torque and drill bit length.
- When using a reciprocating saw be aware of objects behind the cutting surface.
- Use a good quality paint to spray cut edges of frame to prevent rusting.
- Be sure that **ALL** electrical connections are plugged in and accessories are functioning properly before reinstalling the fascia.
- Do not use the towed vehicle for storing luggage, equipment, etc. This may cause you to exceed the towing capacity of the tow bar, baseplate and its accessories.
- Be sure to use Loctite® Red on all bolts before tightening. Tighten all bolts according to the torque chart provided.
- Dealer or installer be certain the user receives these instruction sheet.
- If the baseplate is in an accident, it must be replaced. **DO NOT** use it again! An accident can cause unseen damage and using it again could result in more damage or serious injury. **DO NOT** use the baseplate if it is damaged or missing parts.

BX1989
2003-14 Dodge Ram 2500
2003-14 Dodge Ram 3500
Installation Instructions

- Tools Required**

 - Torque Wrench
 - Loctite® RED
 - 10MM Socket
 - 13MM Socket
 - 18MM Socket
 - 5/8" Socket
 - 5/8" Wrench
 - 11/16" Socket
 - 11/16" Wrench
 - T20 Torx
 - T50 Torx

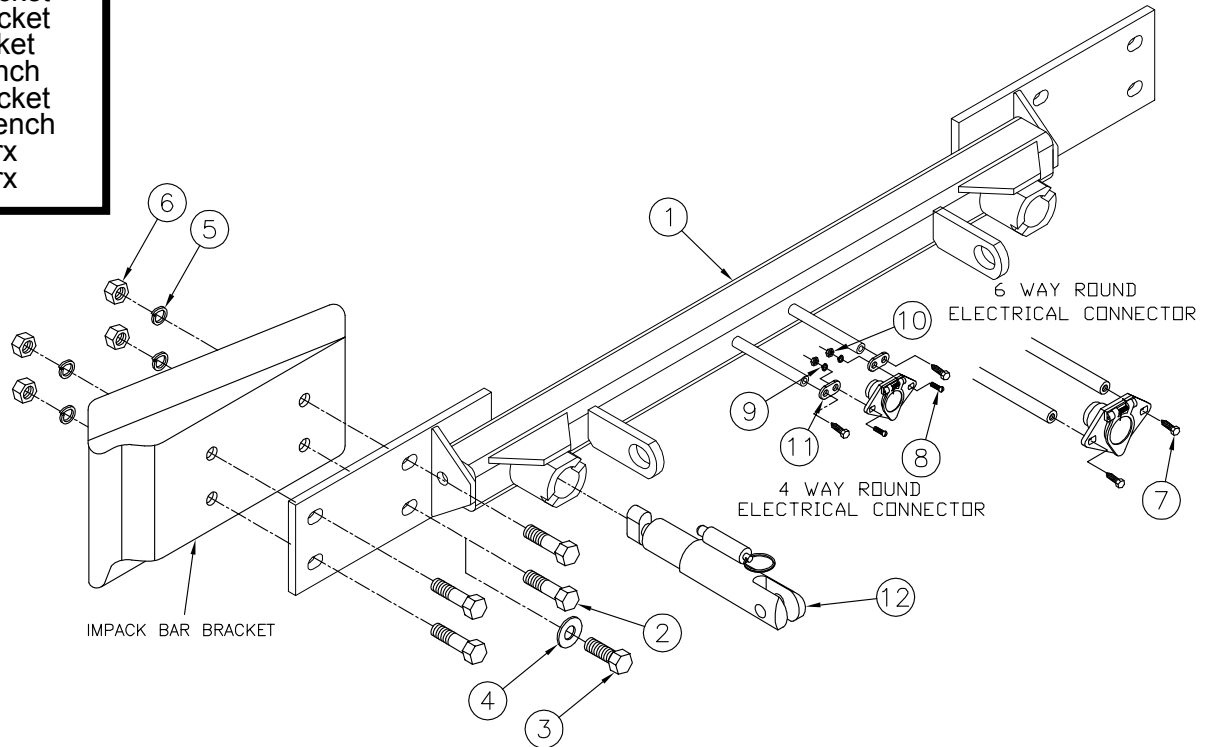

Item No.	Part No.	Description	Qty.
1.....	61-6720.....	BX1989 Baseplate.....	1
2.....	201-0552.....	7/16"-14 x 2" Hex Head Bolt.....	8
3.....	201-0416.....	7/16"-14 x 1-1/2" Hex Head Bolt.....	8
4.....	203-0004.....	7/16" Flat Washer, ZP.....	8
5.....	203-0011.....	7/16" Lock Washer, ZP.....	8
6.....	202-0128.....	7/16"-14 Nylon Insert Lock Nut, ZP.....	8
7.....	201-0553.....	1/4-20 x 1/2" Hex Wshd Bolt Type F TCS, ZP.....	2
8.....	201-0192.....	#10-32 1/2" Round Slotted Head Screw.....	2
9.....	203-0054.....	#10 Lock Washer, ZP.....	2
10.....	202-0047.....	#10-32 Hex Nut.....	2
11.....	101-5822.....	4 Way Connector Adapter.....	2
12.....	62-3468.....	Attachment Tab Assembly with Hole.....	2
13.....	226-0049(not shown).....	Class IV Safety Cables.....	2
14.....	229-0512(not shown).....	1/2" Quicklink, ZP.....	4
15.....	290-0437(not shown).....	Black Cap Plug Receiver.....	2

Important:

Use only genuine factory replacement parts on your baseplate. Do **NOT** substitute homemade or non-typical parts. If a bolt is lost or in need of replacement, for your safety and the preservation of your baseplate, be sure to use a replacement bolt of the same grade (In most cases it will be Grade 5, please reference the parts list above). Replacement parts may be ordered through your nearest Blue Ox® Dealer or Distributor. Failing to follow and/or altering these installation instructions in either installation or required equipment will void the manufacturer's warranty. Towing behind a non-motorized vehicle will void the warranty.

BX1989
2003-14 Dodge Ram 2500
2003-14 Dodge Ram 3500
Installation Instructions

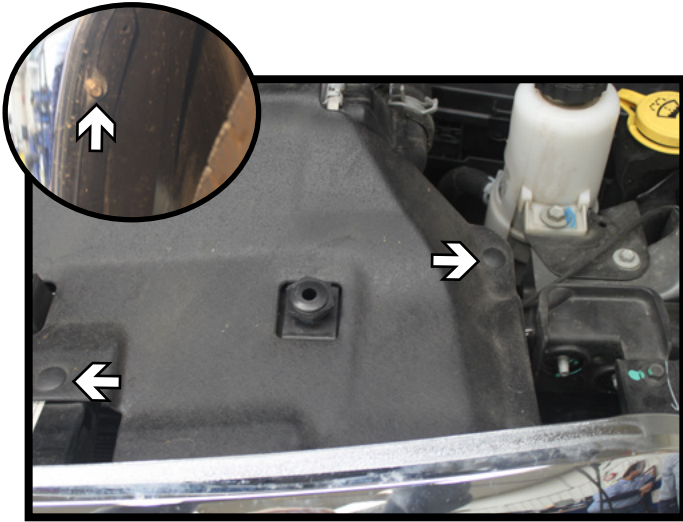

1. **2010-13 Models:** Remove the two (2) pins from the radiator cover. Do this on both sides of the vehicle. Set the cover aside.
In the wheel well, using a 10MM socket, remove the screw from the backside of the bumper (inset). Do this on both sides of the vehicle.

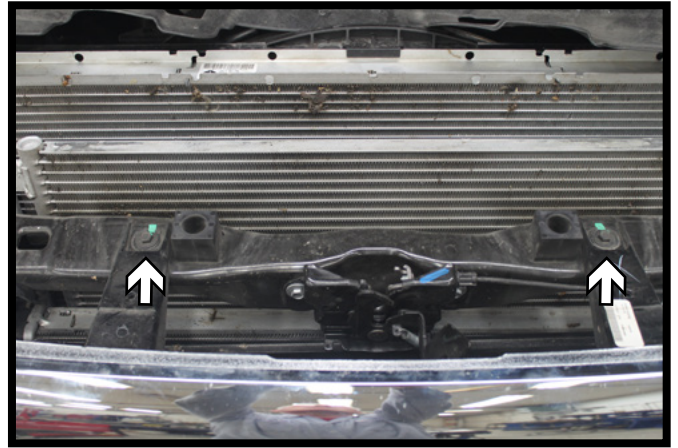

2. **2010-13 Models:** Using a 10MM socket, remove the four (4) bolts from the top of the grille. There are two (2) in the middle and one (1) in each corner. Unsnap the lower section of the grille and set aside.

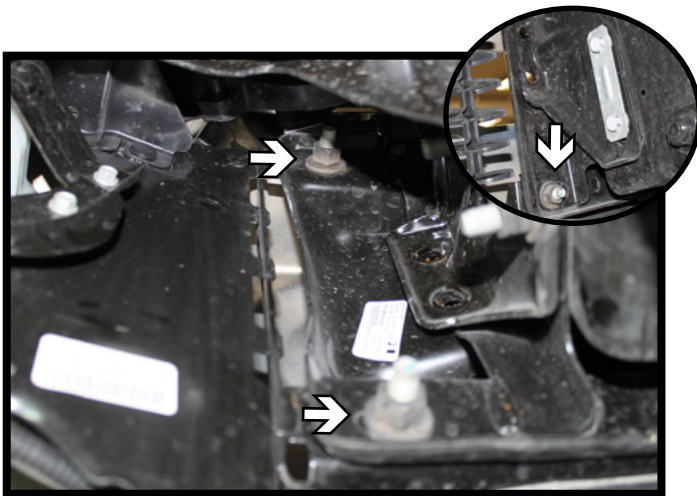

3. Using a 18MM socket, remove the three (3) nuts from the backside of the bumper. Do this on both sides of the vehicle. Remove the bumper and set aside.

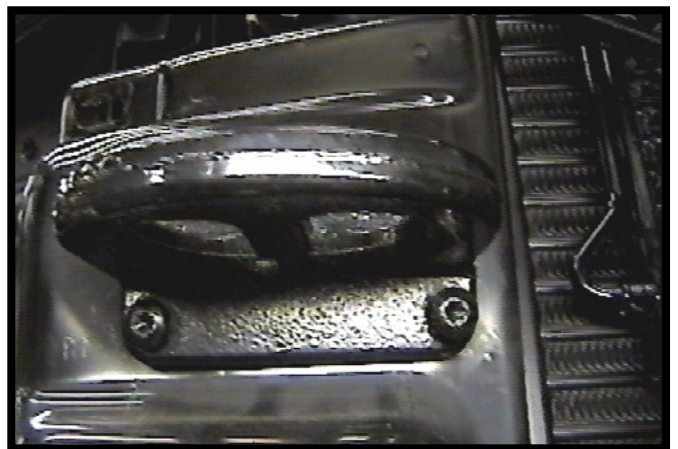

4. Remove the four (4) bolts from the tow hook, using a 50 Torx and/or a 18MM socket. Do this on both sides of the vehicle.

BX1989
2003-14 Dodge Ram 2500
2003-14 Dodge Ram 3500
Installation Instructions

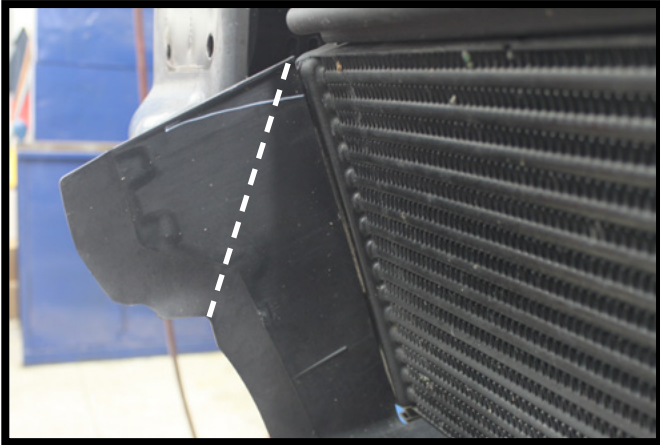

5. **2013 Models:** Trim the lower radiator shroud as shown for D-Link clearance on the baseplate. Do this on both sides of the vehicle.



6. Install the baseplate and tow hooks into the tow hook holes with 7/16"-14 x 2" bolts with 7/16" lock washers and lock nuts.

Note: If no tow hooks are equipped or if not being reinstalled, use the 7/16"-14 x 1-1/2" bolts in lieu of the 7/16"-14 x 2" bolts.

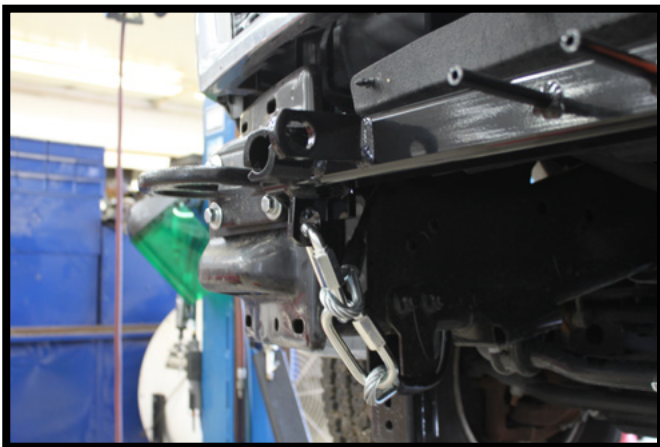

7. Attach the permanent baseplate safety cables to the provided convenience link on the baseplate. The photo above shows the recommended installation of the cables to frame of vehicle. Additional options may interfere with suggested mounting; in this case, secure the cables to a solid piece of the frame as described in the instructions included with the permanent baseplate safety cables. Be sure the safety cables do not rub against any hoses or moving parts. Do this on **BOTH** sides of the vehicle.

BX1989
2003-14 Dodge Ram 2500
2003-14 Dodge Ram 3500
Installation Instructions

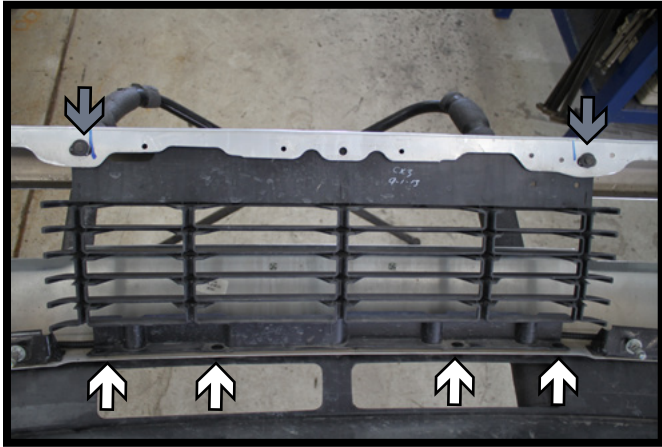

8. **2013 Models:** Using a 10MM socket, remove the two (2) screws from the top edge of the bumper (gray). Then remove the four (4) push pins from the bottom edge (white). Remove the plastic insert. Reinstall the bumper and grille to the vehicle.

All other Models: Reinstall the bumper.

CUSTOMER SERVICE COMMITMENT

Blue Ox® is committed to providing you with exceptional customer care throughout your lifetime with our products. Our team is here to assist you with any questions you may have regarding the performance of your product. Simply call (402) 385-3051 and you can speak with our customer care team.

Additionally, please visit our website to see which rallies our Destination America team will be attending. For a nominal fee, our service technician will service your towing system to ensure it's in proper working condition. Also, as a commitment to our customers, should you visit our factory, you can stay at our full service Blue Ox® campground at no charge along with enjoying a factory tour.

Again, thank you for being our customer and for the confidence you have shown in the performance of our products. It is because of customers like you we enjoy the success we have today.

© 2012 Blue Ox
One Mill Road, Industrial Park
Pender, Nebraska 68047
Phone: (402) 385-3051
Fax: (402) 385-3360
www.blueox.com