

Please read **BOTH** these Installation Instructions and the General Towing Instructions before attempting to install or operate this equipment.

1. Blue Ox® towing products and accessories are intended to be installed by Blue Ox® Dealers who are familiar with our products and have the equipment and knowledge to do “fit work.” Blue Ox® Dealers can be found at www.blueox.us or by contacting our Customer Care Department at (888) 425-5382.

Attachment Tab Height: 18 1/4”
Attachment Tab Width: 22”

2. Many Blue Ox® Baseplates are designed to use existing holes and hardware to mount the baseplate to the towed vehicle. Even though bolts are there, do not assume they are adequate for baseplate mounting. Always use hardware supplied in the hardware kit or existing hardware specified in the Baseplate Towing Installation Instructions.

Bolt Torque Specifications

Torque in Foot-Pounds for Metric Bolts

Bolt Size	Grade 8.8	Grade 10.9
6MM	6	8
8MM	16	22
10MM	31	40
12MM	54	70
14MM	89	117

Confirm the towability and pre-towing procedures for your vehicle with the owner’s manual or contact the vehicle’s manufacturer for specific towing procedures.

Bolt Torque Specifications

Torque in Foot-Pounds for Inch Bolts

Bolt Size	Grade 5	Grade 8
1/4”	10	14
5/16”	19	29
3/8”	33	47
7/16”	54	78
1/2”	78	119
5/8”	154	230

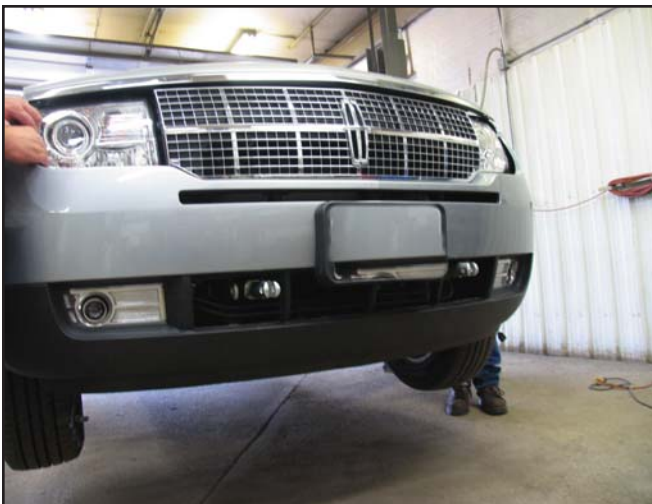

! WARNING

Failure to read and follow these instructions could result in separation of the towed vehicle from the tow bar, causing property damage, loss of towed vehicle, personal injury or death.

BX2192

2007-10 Lincoln MKX

Installation Instructions

Parts List

Ref. No.	Qty.	Part #	Description
1	1	61-6392	Weldment, Baseplate, BX2192
2	2	61-4029	Weldment, 1/2" Nut Wire
3	4	61-4978	3/8" Whiz Nut, w/1/4" Wire
4	2	201-0060	1/2-13x1" Hex Bolt, Grd. 5, ZP
5	2	203-0012	1/2" Lock Washer, ZP
6	2	203-0005	1/2" Flat Washer, ZP
7	4	201-0443	3/8-16x1" Hex Bolt, Grd. 5, ZP
8	4	203-0010	3/8" Lock Washer, ZP
9	4	203-0003	3/8" Flat Washer, ZP
10	4		Existing bolts for bumper mount
11	4		Existing bolts for cross member
12	2	201-0553	1/4-20x1/2" Hex Washed, Type F Screw
13	2	201-0192	#10-32x1/2" Slot, Round Head Screw
14	2	203-0054	#10 Lock Washer
15	2	202-0047	#10-32 Hex Nut
16	2	101-5822	Adapter, 4 Way Connector
17	2	62-3468	Attachment, Assembly, SF/SB, 1 Hole
	2	201-0050	1/4-20 x 3/4 Hex Bolt, Grd 5., ZP (Not Shown)
	2	202-0069	1/4-20 Hex Flange Whiz Lock Nut, ZP (Not Shown)
	2	290-0437	Cap Plug, Black (Not Shown)
	2	229-0359	Quicklink, 3/8", ZP (Not Shown)
	2	226-0046	Baseplate Safety Cable, 36" Class III (Not Shown)

Tools Required

Loctite® RED	3/4" Socket
Phillips Screwdriver	9/16" Socket
Hammer	8MM Socket
Reciprocating Saw	13MM Socket
1 1/4" Hole Saw	10MM Socket
Utility Knife	5.5MM Socket

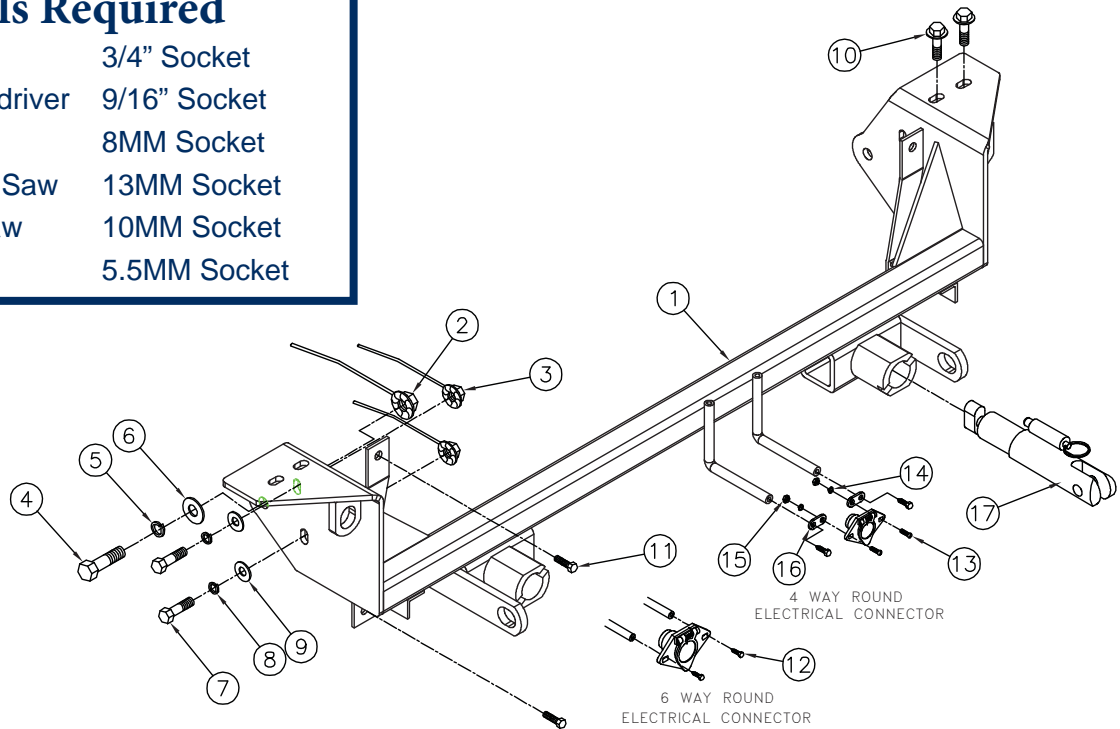

Important:

Use only genuine factory replacement parts on your baseplate. Do **NOT** substitute homemade or non-typical parts. If a bolt is lost or in need of replacement, for your safety and the preservation of your baseplate, be sure to use a replacement bolt of the same grade (In most cases it will be Grade 5, please reference the parts list above). Replacement parts may be ordered through your nearest Blue Ox® Dealer or Distributor.

BX2192

2007-10 Lincoln MKX

Installation Instructions

Vehicle Weight:

Motorhome mount tow bars are recommended for use with this baseplate. Due to the design of the removable tabs, the RangeFinderII, Adventurer, and Ambassador tow bars can not be used. The Acclaim tow bar may be used, but will not fold and store on the front of the vehicle. Adapters, except the BX8833 and BX88151, can not be used with this baseplate.

Installation Notes: The fascia and water reservoir are removed and reinstalled during installation of the baseplate. Drilling is required. Trimming of the fascia is required.

The dimensional variations between otherwise identical vehicles can be considerable. While the baseplate was designed for easy installation, it may be necessary to tailor the baseplate slightly to compensate for auto manufacturer's tolerances. These minor adjustments may include filing a hole slightly, bending electrical rods and/ or bending end plates.

The BX8869 Bulb & Socket Wiring Kit is recommended for both the 2007-08 models.



Installation Instructions:

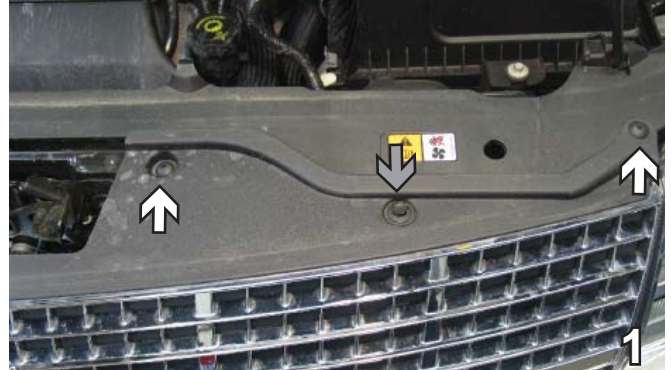

1. Using a Phillips screwdriver, remove two plastic Phillips push pins (see white arrows) and then using a 10MM socket, remove one metric bolt (see grey arrow) from the flat plastic piece just above grille. Do this to both sides of the vehicle. Set bolts and push pins aside to be reinstalled later.



2. Using a 5.5MM socket, remove three metric bolts just forward of the front tire on the wheel well. Do this to both sides of the vehicle. Set bolts and push pins aside to be reinstalled later.

BX2192
2007-10 Lincoln MKX
Installation Instructions

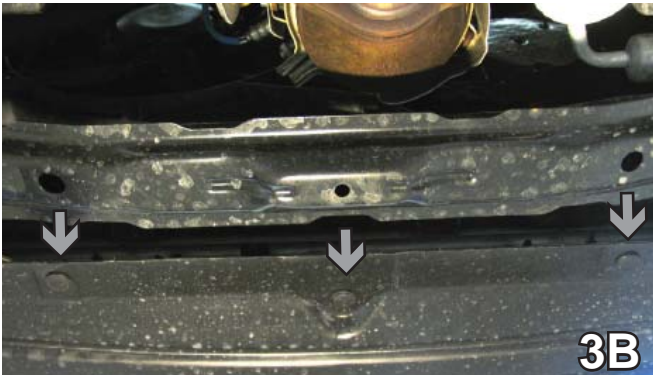
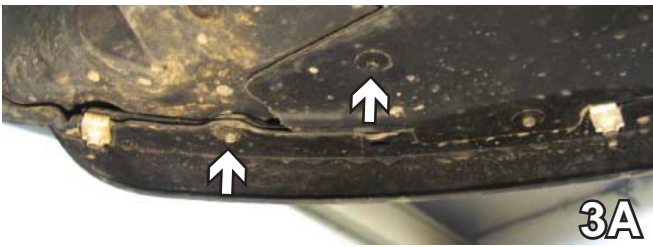

- Using a 5.5MM socket, remove two metric bolts from underneath the front edge of fascia (see white arrows). Do this to both sides of the vehicle. Then using a flat screwdriver, remove three push pins that are located in the center of vehicle on the belly pan (see grey arrows). Set bolts and push pins aside to be reinstalled later. After all the bolts and push pins are removed, the corner of fascia is then pulled out to the side and forward to remove. Carefully set fascia aside to be reinstalled later.

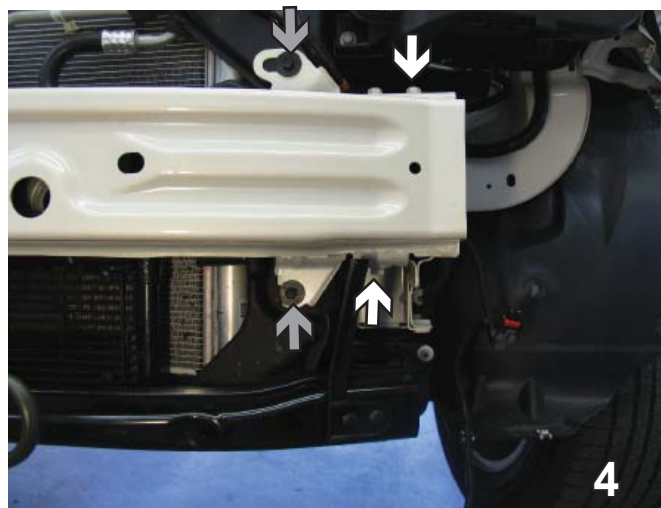

- Using a 13MM socket, remove two metric bolts from the top of the metal bumper and one metric bolt from the bottom (see white arrows). These black 6MM bolts (grey arrows) support the radiator carriage. Be sure to mark the height on carriage to the top of frame rail before removing bolts. This will alter hood latch height determining proper hood closure. Then using a 10MM socket, remove one metric bolt from the top and bottom of the bumper (see grey arrows).

NOTE: These black 6MM bolts (grey arrows) support radiator carriage. Be sure to mark the height on carriage to top of frame rail before removing bolts. This will alter hood latch height, determining proper hood closure.

Do this to both sides of the vehicle. Set bolts aside to be reinstalled later. The metal bumper will not be reinstalled on vehicle is on and should be returned to customer.

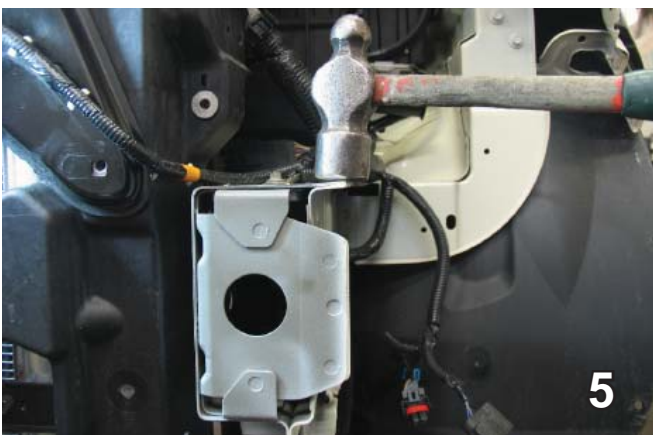

- You will need to flatten the top of the frame rail a couple times with a hammer until level. You can use a straight edge as a guide. Do this to both sides of the vehicle.

BX2192
2007-10 Lincoln MKX
Installation Instructions

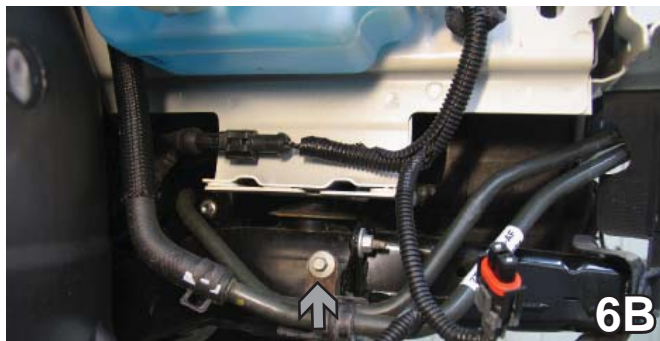
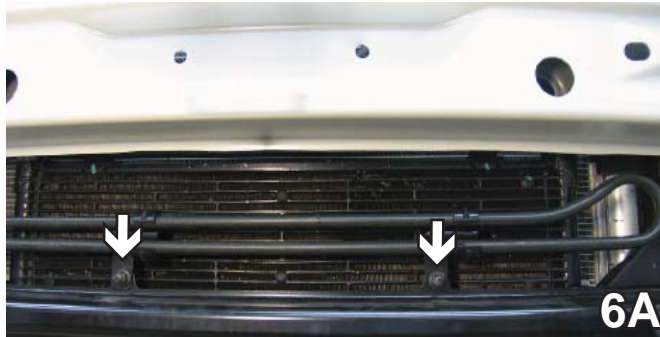

6. Using a 10MM socket, remove two metric bolts from the lower coolant line located on the front of the vehicle. Then using a 8MM socket, remove one metric bolt located on the passenger side of the vehicle for the lower coolant line. Set bolt aside to be reinstalled later and discard the Hex nuts, because the coolant line will be mounted in a new location.



8. Take a tape measure and measure one inch up from the bottom of the mounting tabs located on the coolant line and make a mark. Take a vise grips and bend both tabs back towards to radiator.



7. Using a reciprocating saw, cut off the tabs that the lower coolant line was attached to. Be careful not to cut into radiator. Use bracket as template and drill with a 9/32" drill bit into the top of the cross member. Bolt coolant brackets to the top of cross member using the 1/4" x 3/4" hex bolt and 1/4" whiz nut with the 7/16" socket. Do this to both brackets.



9. Remove coolant line brackets on the back side and relocate to the front of the coolant line. Using the bracket as a template, drill into lower cross member and install 1/4-20 x 3/4" hex bolt and whiz nut on the back side of the cross member. Do this to both sides.

BX2192
2007-10 Lincoln MKX
Installation Instructions

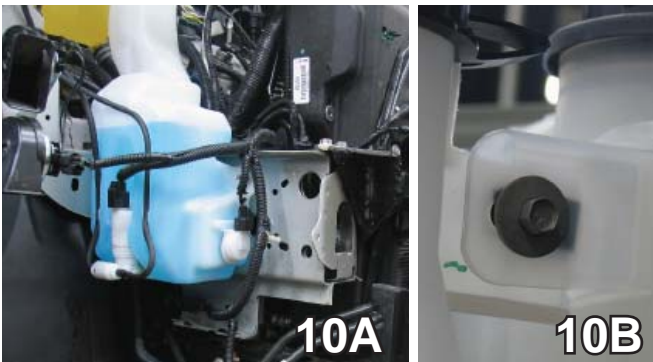

10. The water reservoir on the passenger's side will need to be removed from the passenger side of the vehicle by removing the three metric bolts with the 10MM and 8MM socket. Set water reservoir and bolts aside to be reinstalled later.



11. Using a reciprocating saw, make the two vertical cuts and bend the cut area into the frame end and as far down as possible. Do this to both sides of the vehicle.

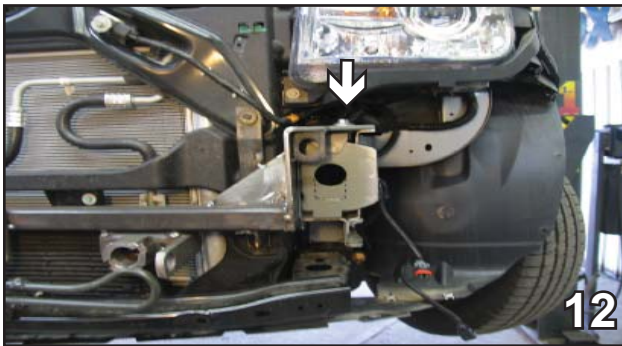

12. Place baseplate on top of frame and line up the holes in the baseplate with the two existing holes on top of the frame. Insert one existing 13MM bolt removed in step 6, to hold baseplate into place with the 13MM socket. Do this to both sides of the vehicle.



13. Using a 1 1/4" hole saw, drill two 1 1/4" holes into the frame, utilizing the two existing holes in the side of the frame so an extension can be used to tighten up bolts. Do this to both sides of the vehicle.

BE SURE TO USE LOCTITE® RED ON ALL BOLTS BEFORE TIGHTENING. TIGHTEN ALL BOLTS ACCORDING TO THE TORQUE CHART ON THE FRONT PAGE OF THESE INSTRUCTIONS OR ON PAGE 3 OF THE BASEPLATE TOWING GENERAL INSTRUCTIONS.



14. Align lower base plate holes to existing holes. Should meet but may need to be reamed out using 13/32" and 17/32" drill bit. Do to both sides of the vehicle.

BX2192
2007-10 Lincoln MKX
Installation Instructions

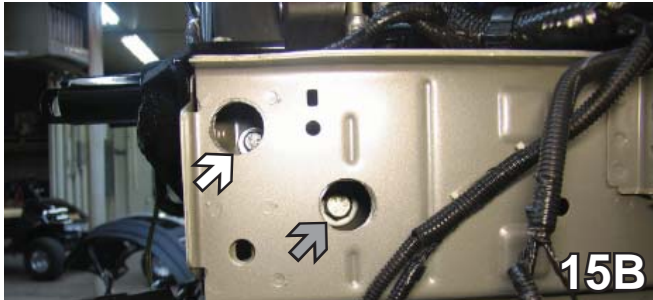

15. Using the baseplate as a template, insert a 3/8-16x1" hex bolt, 3/8" lock washer and 3/8" flat washer into the two outside holes and tighten down with a 3/8-16 whiz nut w/14" wire (see white arrows). You will then insert a 1/2-13x1" hex bolt, 1/2" lock washer and 1/2" flat washer and tighten down with a 1/2" nut plate (see grey arrow). Do this to both sides of the vehicle.

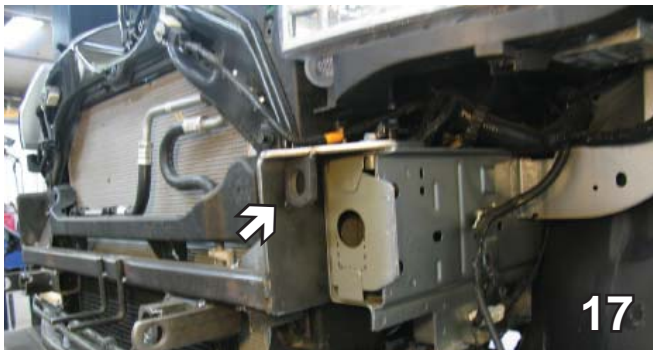

17. The arrow in the photo above shows the recommended installation of the cables to the frame of the vehicle. Additional options may interfere with suggested mounting, in this case secure the cables to a solid piece of the frame as described in the instructions included with the permanent baseplate safety cables. Be sure the safety cables do not rub against any hoses or moving parts.

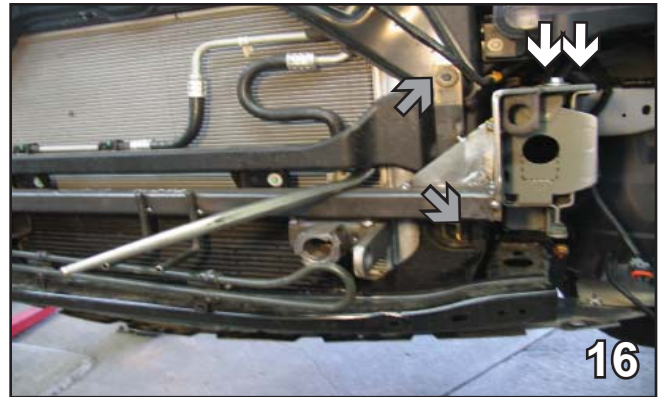

16. After the bolts in Step 15 are installed, you can reinstall the top two 13MM bolts removed in Step 4 (see white arrows) and also the two 10MM bolts removed in Step 6, to hold radiator support back in place (see grey arrows). Do this to both sides of the vehicle.

NOTE: BE SURE TO ADJUST THE HEIGHT OF RADIATOR CARRIAGE (REFER TO STEP 4)

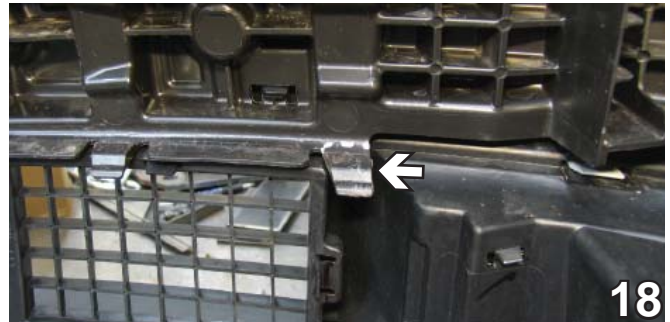

18. Using a hack saw blade, trim off tab located on the back side of the fascia. Do this to both sides of the vehicle.



19. Using a hack saw blade, trim away plastic areas located on the back side of the fascia, just above the fascia opening as indicated in photos 19A, 19B and 19C. Do this to both sides of the fascia.

19A. Measure 2 1/2" back and along the baseline of the plastic and all the way around. Mark and trim.

BX2192
2007-10 Lincoln MKX
Installation Instructions



19B. Fascia shown after step 18A is completed and the additional bit of plastic towards the webbing is removed.

19C. Measure another 1/2" outwards, mark and trim.

Be sure that **ALL** electrical connections are plugged in properly and functioning **BEFORE** installing the fascia.



20. Reinstall washer reservoir and fascia to original positions.
Install the tow bar and safety cables according to the instructions provided in their packages. When demonstrating this to the customer, be sure to include all the contents and packages.

Do **NOT** substitute other devices if the tow bar pins and clips are misplaced.

DEALER or INSTALLER:
Be certain the user receives the instruction sheets for their products.

CUSTOMER SERVICE COMMITMENT

Blue Ox is committed to providing you with exceptional customer care throughout your lifetime with our products. Our team is here to assist you with any questions you may have regarding the performance of your product. Simply call 1-800-228-9289 and you can speak with our customer care team.

Additionally, please visit our website to see which rallies our Destination America team will be attending. For a nominal fee, our service technician will service your towing system to ensure it's in proper working condition. Also as a commitment to our customers, should you visit our factory you can stay at our full service Blue Ox campground at no charge along with enjoying a factory tour.

Again thank you for being our customer and for the confidence you have shown in the performance of our products. It is because of customers like you we enjoy the success we have today.



© 2007, 08, 09 Blue Ox
One Mill Road, Industrial Park
Pender, Nebraska 68047
Phone: (402) 385-3051 • Fax: (402) 385-3360
www.blueox.us