

CONTOURE™

SPACE SAVER APPLIANCES

1.2 cu.ft Black, Built-in Microwave Oven with Convection

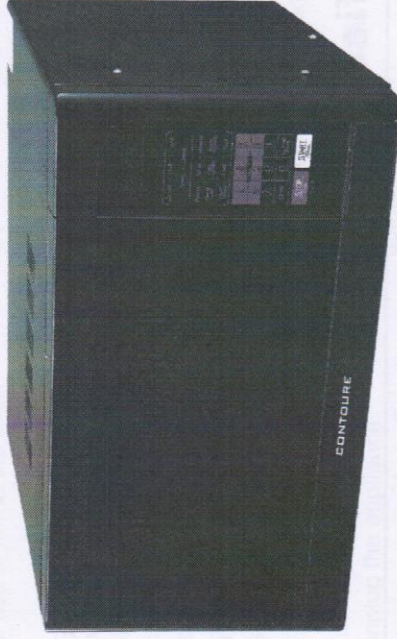

Model:RV-185B-CON

Read these instructions carefully before using your microwave oven, and keep it carefully.

If you follow the instructions, your oven will provide you with many years of good service.

Available from
<https://www.rvupgradestore.com>

PRECAUTIONS TO AVOID POSSIBLE EXPOSURE TO EXCESSIVE MICROWAVE ENERGY

- (a) Do not attempt to operate this oven with the door open since this can result in harmful exposure to microwave energy. It is important not to defeat or tamper with the safety interlocks.
- (b) Do not place any object between the oven front face and the door or allow soil or cleaner residue to accumulate on sealing surfaces.
- (c) **Do not operate the oven if it is damaged. It is particularly important that the oven door closes properly and that there is no damage to the:**
 - (1) DOOR (bent)
 - (2) HINGES AND LATCHES (broken or loosened)
 - (3) DOOR SEALS AND SEALING SURFACE
- (d) **The oven should not be adjusted or repaired by anyone except properly qualified service personnel.**

ADDENDUM

If the apparatus is not maintained in a good state of cleanliness, its surface could be degraded and affect the lifespan of the apparatus and lead to a dangerous situation.

Specifications

Model:	RV-185B-CON
Rated Voltage:	120V~60HZ
Rated Input Power(Microwave):	1500W
Rated Output Power(Microwave):	1000W
Rated Input Power(Grill):	1150W
Rated Input Power(Convection):	1500W
Oven Capacity:	1.2 Cu.ft (28 Litre)
Turntable Diameter:	Ø12.5 inch (315 mm)
External Dimensions(LxWxH):	20.5X18.7X14.9 inch (520mmX474mmX378.9mm)
Net Weight:	Approx 45.4 Lbs (20.6 kg)

IMPORTANT SAFETY INSTRUCTIONS WARNING

To reduce the risk of burns, electric shock, fire, injury to persons or exposure to excessive microwave oven energy when using your appliance, follow basic safety precautions, including the following:

1. Read all instructions before using the appliance.
2. Read and follow the specific: **"PRECAUTIONS TO AVOID POSSIBLE EXPOSURE TO EXCESSIVE MICROWAVE ENERGY"** found on page 2.
3. As with most cooking appliances, close supervision is necessary to reduce the risk of a fire in the oven cavity.
4. To reduce the risk of fire in the oven cavity:
 - i). Do not overcook food. Carefully attend the appliance when paper, plastic, or other combustible materials are placed inside the oven to facilitate cooking.
 - ii). Remove wire twist-ties and metal handles from paper or plastic containers/bags before placing them in the oven.
 - iii). If materials inside the oven ignite, keep the oven door closed. Turn the oven off, and unplug the appliance. Disconnect the power cord, shut off power at the fuse or circuit breaker panel.
 - iv). Do not use the oven cavity for storage purposes. Do not leave paper products, cooking utensils, or food in the cavity when not in use.
5. This oven must be grounded. Connect only to properly grounded outlet. See **"GROUNDING INSTRUCTIONS"** found on page 4.
6. Install or locate this oven only in accordance with the installation instructions provided.
7. Some products such as whole eggs and sealed containers-for example, closed glass jars-are able to explode and should not be heated in the oven.
8. Use this appliance only for its intended uses as described in this manual. Do not use corrosive chemicals or vapors in this appliance. This oven is specifically designed to heat or cook or dry food. It is not designed for industrial or laboratory use.
9. As with any appliance, close supervision is necessary when used by children.
10. Do not operate this oven if it has a damaged cord or plug, if it is not working properly or if it has been damaged or dropped.
11. This appliance should be serviced only by qualified service technicians. Contact the nearest authorized service facility for examination, repair or adjustment.
12. Do not cover or block any openings on the oven.
13. Do not store or use this appliance outdoors.
14. Do not use this oven near water, for example, near a kitchen sink, in a wet basement, near a swimming pool, or similar locations.
15. Do not immerse cord or plug in water.
16. Keep cord away from heated surfaces.
17. Do not let cord hang over edge of table or counter.
18. When cleaning surfaces of door and oven that comes together on closing the door, use only mild, nonabrasive soaps or detergents applied with a sponge or soft cloth.

19. Liquids, such as water, coffee, or tea are able to be overheated beyond the boiling point without appearing to be boiling. Visible bubbling or boiling when the container is removed from the microwave oven is not always present. **THIS COULD RESULT IN VERY HOT LIQUIDS SUDDENLY BOILING OVER WHEN THE CONTAINER IS DISTURBED OR A SPOON OR OTHER UTENSIL IS INSERTED INTO THE LIQUID.**

- i) Do not overheat the liquid.
- ii) Stir the liquid both before and halfway through heating it.
- iii) Do not use straight-sided containers with narrow necks.
- iv) After heating, allow the container to stand in the microwave oven for a short time before removing the container.
- v) Use extreme care when inserting a spoon or other utensil into the container.

SAVE THESE INSTRUCTIONS

GROUNDING INSTRUCTIONS

DANGER

Electric Shock Hazard

Touching some of the internal components can cause serious personal injury or death. Do not disassemble this appliance.

WARNING

Electric Shock Hazard

Improper use of the grounding can result in electric shock. Do not plug into an outlet until appliance is properly installed and grounded.

Three-pronged (grounding) plug



This appliance must be grounded. In the event of an electrical short circuit, grounding reduces the risk of electric shock by providing an escape wire for the electric current. This appliance is equipped with a cord having grounding wire with a grounding plug. The plug must be plugged into an outlet that is properly installed and grounded.

Consult a qualified electrician or serviceman if the grounding instructions are not completely understood or if doubt exists as to whether the appliance is properly grounded. If it is necessary to use an extension cord, use only a 3-wire extension cord that has a 3-pronged grounding plug, and a 3-slot receptacle that will accept the plug on the appliance. The marked rating of the extension cord shall be equal to or greater than the electrical rating of the appliance.

1. A short power-supply cord is provided to reduce the risks resulting from becoming entangled in or tripping over a longer cord.

2. Longer cord sets or extension cords are available and may be used if cared for as exercised in their use.

3. If a long cord sets or extension cord is used:

- 1) The marked electrical rating of the cord set or extension marked electrical rating of the cord set or extension cord should be at least as great as the electrical rating of the appliance.
- 2) The extension cord must be a grounding-type 3-wire cord; and
- 3) The longer cord should be arranged so that it will not drape over the countertop or tabletop where it can be pulled on by children or tripped over unintentionally.

Radio Interference

1. Operation of the microwave oven may cause interference to your radio, TV or similar equipment.

2. When there is interference, it may be reduced or eliminated by taking the following measures:

- 1) Clean door and sealing surface of the oven
- 2) Reorient the receiving antenna of radio or television.
- 3) Relocate the microwave oven with respect to the receiver.
- 4) Move the microwave oven away from the receiver.
- 5) Plug the microwave oven into a different outlet so that microwave oven and receiver are on different branch circuits.

UTENSILS

See the instructions on "Materials you can use in microwave oven or to be avoided in microwave oven." There may be certain non-metallic utensils that are not safe to use for microwaving. If in doubt, you can test the utensil in question following the procedure below.

Utensil Test:

1. Fill a microwave-safe container with 1 cup of cold water (250ml) along with the utensil in question.
2. Cook on maximum power for 1 minute.
3. Carefully feel the utensil. If the empty utensil is warm, do not use it for microwave cooking.
4. **Do not exceed 1 minute cooking time.**

CAUTION

Personal Injury Hazard

Tightly-closed utensils could explode. Closed containers should be opened and plastic pouches should be pierced before cooking.

Materials you can use in microwave oven

Utensils	Remarks
Aluminum foil	Shielding only. Small smooth pieces can be used to cover thin parts of meat or poultry to prevent overcooking. Arcing can occur if foil is too close to oven walls. The foil should be at least 1 inch (2.5cm) away from oven walls.
Browning dish	Follow manufacturer's instructions. The bottom of browning dish must be at least 3/16 inch (5mm) above the turntable. Incorrect usage may cause the turntable to break.
Dinnerware	Microwave-safe only. Follow manufacturer's instructions. Do not use cracked or chipped dishes.
Glass jars	Always remove lid. Use only to heat food until just warm. Most glass jars are not heat resistant and may break.
Glassware	Heat-resistant oven glassware only. Make sure there is no metallic trim. Do not use cracked or chipped dishes.
Oven cooking bags	Follow manufacturer's instructions. Do not close with metal tie. Make slits to allow steam to escape.
Paper plates and cups	Use for short-term cooking/warming only. Do not leave oven unattended while cooking.
Paper towels	Use to cover food for reheating and absorbing fat. Use with supervision for a short-term cooking only.
Parchment paper	Use as a cover to prevent splattering or a wrap for steaming.
Plastic	Microwave-safe only. Follow the manufacturer's instructions. Should be labeled "Microwave Safe". Some plastic containers soften, as the food inside gets hot. "Boiling bags" and tightly closed plastic bags should be slit, pierced or vented as directed by package.
Plastic wrap	Microwave-safe only. Use to cover food during cooking to retain moisture. Do not allow plastic wrap to touch food.
Thermometers	Microwave-safe only (meat and candy thermometers).
Wax paper	Use as a cover to prevent splattering and retain moisture.

Materials to be avoided in microwave oven

Utensils	Remarks
Aluminum tray	May cause arcing. Transfer food into microwave-safe dish.
Food carton with metal handle	May cause arcing. Transfer food into microwave-safe dish.
Metal or metal-trimmed utensils	Metal shields the food from microwave energy. Metal trim may cause arcing.
Metal twist ties	May cause arcing and could cause a fire in the oven.
Paper bags	May cause a fire in the oven.
Plastic foam	Plastic foam may melt or contaminate the liquid inside when exposed to high temperature.
Wood	Wood will dry out when used in the microwave oven and may split or crack.

SETTING UP YOUR OVEN

Names of Oven Parts and Accessories

Remove the oven and all materials from the carton and oven cavity. Your oven comes with the following accessories:

- Glass tray 1
- Turntable ring assembly 1
- Instruction Manual 1

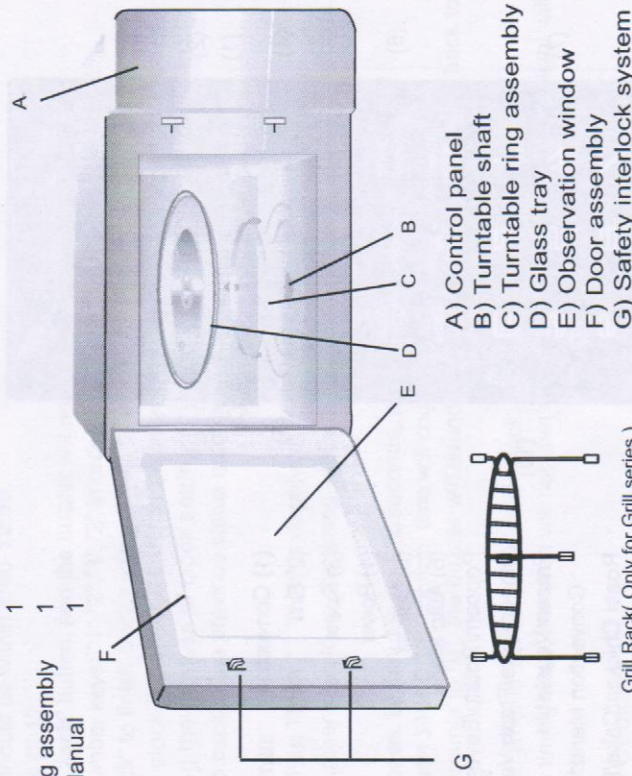

Turntable Installation

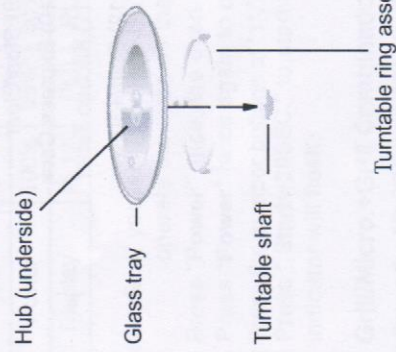

- a. Never place the glass tray upside down. The glass tray should never be restricted.
- b. Both glass tray and turntable ring assembly must always be used during cooking.
- c. All food and containers of food are always placed on the glass tray for cooking.
- d. If glass tray or turntable ring assembly cracks or breaks, contact your nearest authorized service center.

OPERATION

Control Panel and Features

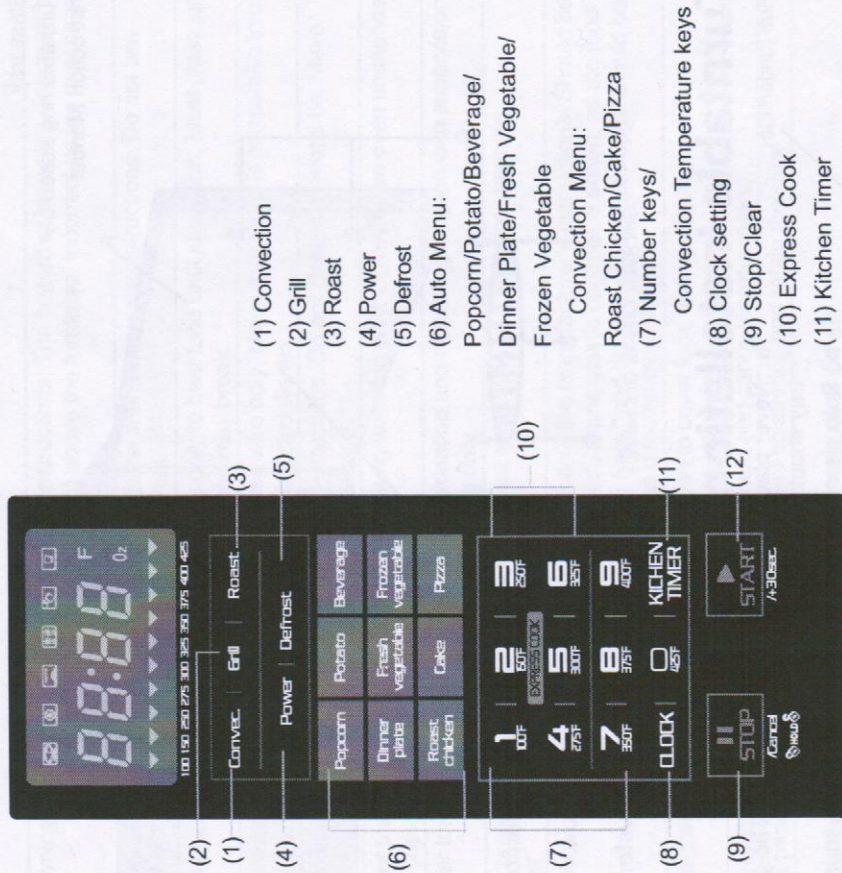

- (1) Convection
- (2) Grill
- (3) Roast
- (4) Power
- (5) Defrost
- (6) Auto Menu:
Popcorn/Potato/Beverage/
Dinner Plate/Fresh Vegetable/
Frozen Vegetable
- Convection Menu:
Roast Chicken/Cake/Pizza
- (7) Number keys/
Convection Temperature keys
- (8) Clock setting
- (9) Stop/Clear
- (10) Express Cook
- (11) Kitchen Timer
- (12) Start/+30Sec.

OPERATION INSTRUCTION

1. Clock Setting

When the microwave oven is electrified, the oven will display "0:00", and buzzer will ring once.

The input time should be within 1:00-12:59.

Example: To set 12:12.

- (1) Press the "Clock" button, and the buzzer will ring once.
 - (2) Press the number keys: "1", "2", "1", "2" in order.
 - (3) Press "Clock" to finish clock setting. ":" will flash, and the time will light.
- Note:** 1) If the clock is not set, "0:00" is displayed and the clock will not count.
2) During the process of clock setting, if you press "Stop/Clear", the oven will go back to the previous status automatically.

2. Kitchen Timer

- (1) Press "Kitchen Timer", "0:00" is displayed.
 - (2) Press the number keys to set the timing within the range of 99 minutes and 99 seconds.
- For example:
set kitchen timer as 12 minutes and 12 seconds, please press "1,2,1,2" in turn.
- (3) Press "Start/+30SEC." to confirm; time will count down and display.
 - (4) When time counts to "0", the buzzer will sound 5 times and the oven will turn back to the normal state.

Note: (1) Kitchen timer is a timer as an alarm clock.

- (2) In the timing state, the oven will not start with any program and the oven light will not light.

3. Microwave Cooking

Select different microwave power level and set cooking time as you wish. There are 10 power levels available for choosing. Keep on pressing "Power" to choose the power.

Level	10	9	8	7	6	5	4	3	2	1
Power	100%	90%	80%	70%	60%	50%	40%	30%	20%	10%
Display	PL10	PL9	PL8	PL7	PL6	PL5	PL4	PL3	PL2	PL1

Example: If you want to use 80% microwave power to cook for 10 minutes, you can operate the oven as the following steps.

- 1) Press "Power" once, the oven will display "PL10".
- 2) Press "Power" twice again to choose 80% power, the oven will display "PL8".
- 3) Press the number buttons of "1", "0", "0", "0" in order, the oven will display "10:00".
- 4) Press "Start/+30SEC." to start cooking, ":" will light and the "Micro." indicator will flash.

4. Grill/Micro.+Grill Combination Cooking

- (1) Press the "Grill" button once to choose the grill function, the oven will display "G-1" and "Grill" indicator will light.(Press twice or thrice to choose the combination function with "G-2" or "G-3" displaying)

(2) Set the cooking time.

Example: Set 12 minutes 50 seconds, press "1", "2", "5", "0" in order.

(3) Press "**Start/+30SEC.**" to start cooking. The cooking time counts down, "." will light and "Grill" indicator will flash.

Note: If half the grill time passes, the oven sounds twice, and this is normal. It denotes turning food over in order to have a better effect of grilling food, and you should turn the food over, close the door, and then press "**Start/+30SEC.**" to continue cooking.

Note: "Grill" Pad presses instructions

Presses Instructions	Display	Microwave	Grill
1	G-1		100%
2	G-2	36%	64%
3	G-3	55%	45%

5. Convection Cooking

The convection cooking can let you to cook the food as a traditional oven. Microwave is not used. It is recommended that you should preheat the oven to the appropriate temperature before placing the food in the oven.

There are ten temperatures of convection: 100F, 150F, 250F, 275F, 300F, 325F, 350F, 375F, 400F, 425F.

A. With preheating convection

1) Press the "**CONVEC.**" once, the oven will display "100". "F" and "Conv." indicator will light. (Press the convection temperature key to select the temperature you need.)
2) Press "**Start/+30SEC.**" button to start preheating.

The temperature figure will flash when the oven reach the temperature setted, and buzzer will ring twice to remind you to put food into the oven, then close the door.

3) Press the number keys to set cooking time.
4) Press the "**Start/+30SEC.**" button to start cooking.

"Conv." indicator will flash, "." will light, and cooking time will count down.

Note: a. Cooking time cannot be input until the preheating temperature arrives.

If the temperature arrives, door must be opened to input the cooking time.

b. If the time not input in 5 minutes, the oven will stop preheating. The buzzer sound five times and turn back to waiting states.

B. Convection Cooking(Without preheating function)

1) Press the "**Convec**" once, the oven will display "100". "F" and "Conv." indicator will light. (Press the convection temperature key to select the temperature you need.)

2) Press the "**Convec**" button to confirm the temperature.

3) Press the number keys to set cooking time.

4) Press the "**Start/+30SEC.**" button to start cooking.

"Conv." indicator will flash, "." will light, and cooking time will count down.

6. Convection Roast Cooking

1) Press "**Roast**" once, the oven will display "325F", and the "Micro.", "Conv." indicator will light. (Press the convection temperature key to select the temperature you need.)
2) Press "**Roast**" button to confirm the temperature.

3) Press the number keys to set cooking time.

4) Press "**Start/+30SEC.**" button to start cooking, "." will light, and cooking time will count down.

7. Defrost By Weight

1) Press "**Defrost**" once, the oven will display "dEF1". "Micr.", "Defrost" indicators will light.

2) Press the number keys to set defrosting weight within the range of 4 to 100 oz, and "Oz" will light.

3) Press "**Start/+30SEC.**" button to start defrosting, and "Oz" will disappear.

8. Defrost By Time

1) Press "**Defrost**" twice, the oven will display "dEF2". "Micr.", "Defrost" indicators will light.

2) Press the number keys to set defrosting time. The max.time is 99 minutes 99 seconds.

3) Press "**Start/+30SEC.**" button to start defrosting.

9. Multi-Stage Cooking

Two stages of cooking can be maximumly set. If one of the stages is defrosting, then it should be put in the first stage. The buzzer will ring once after each stage cooking and the next stage will begin.

Note: Auto menu cooking cannot be set as one of the multi-stage.

Example: cooking with 100% microwave power for 5 minutes and then 70% microwave power for 10 minutes. The steps are as the following:

1) Press "**Power**" once, "PL10" is displayed;

2) Press number keys "5", "0", "0" to adjust the cooking time as you need;

3) Press "**Power**" four times to choose 70% microwave power, "PL7" is displayed;

4) Press number keys "1", "0", "0", "0" to adjust the cooking time as you need.

5) Press "**Start/ +30 SEC.**" to start cooking.

10. Speedy Cooking

- (1) In waiting state, instant cooking at 100% power level can be started by selecting cooking time from 1 to 6 minutes by pressing numeral pads 1 to 6. Press "**Start/ +30 SEC.**" to increase the cooking time 30 seconds by each added pressing; the maximum cooking time is 99 minutes and 99 seconds.
- (2) In waiting state, instant cooking at 100% power level with 30 seconds' cooking time can be started by pressing "**Start/ +30 SEC.**". Each press on the same button will increase cooking time by 30 seconds. the maximum cooking time is 99 minutes and 99 seconds.

Note: In microwave, grill, convection or combination cooking state, 30 seconds' cooking time can be added by each pressing of "**Start/ +30 SEC.**" button, and it's invalid at the function of defrost, multi-stage or auto menu cooking.

11. Auto Menu Cooking

- (1) In waiting state, press the button of "**Popcorn**", "**Potato**", "**Beverage**", "**Dinner Plate**", "**Fresh Vegetable**", "**Frozen Vegetable**", "**Roast Chicken**", "**Cake**" or "**Pizza**" to choose the function and weight of food as you need.

- (2) Press "**Start / +30 SEC.**" to start cooking.

Note: Refers to the next page for auto menu chart.

12. Lock-out Function for Children

Lock: In waiting state, press "**STOP/CLEAR**" for 3 seconds, there will be a long "beep" denoting entering into the children-lock state and "**LO**" indicator will light. LED will display current time or 0:00.

Lock quitting: In locked state, press "**STOP/CLEAR**" for 3 seconds, there will be a long "beep" denoting that the lock is released, and "**LO**" indicator will disappear.

13. State Inquiry

- (1) During cooking, press "**Convec**", "**Power**", "**Grill**" to check the responding power, and the power will be displayed for 2-3 seconds;
- (2) During cooking, press "**Clock**" to check the current time, and the time will be displayed for 2-3 seconds.

Pay Special Attention:

When cooking with "Microwave", "Convection", "Grill", "Roast" or "Time Defrost" function, the maximum cooking time is 99 minutes and 99 seconds.

Auto menu Chart

Menu	Weight (Oz)	Display
Popcorn	1.75 OZ	1.75 OZ
	3.00 OZ	3.00 OZ
	3.50 OZ	3.50 OZ
Potato	1 portion	1
	2 portions	2
	3 portions	3
Beverage	about 8.80 OZ	1
	about 17.60 OZ	2
	about 26.40 OZ	3
Dinner Plate	8.00 OZ	8.00 OZ
	12.00 OZ	12.00 OZ
	16.00 OZ	16.00 OZ
Fresh Vegetable	4.00 OZ	4.00 OZ
	8.00 OZ	8.00 OZ
	16.00 OZ	16.00 OZ
Frozen Vegetable	4.00 OZ	4.00 OZ
	8.00 OZ	8.00 OZ
	16.00 OZ	16.00 OZ
Roast Chicken	16.00 OZ	16.00 OZ
	24.00 OZ	24.00 OZ
	32.00 OZ	32.00 OZ
Cake	40.00 OZ	40.00 OZ
	48.00 OZ	48.00 OZ
	16.00 OZ	16.00 OZ
Pizza	10.00 OZ	10.00 OZ
	22.00 OZ	22.00 OZ

Note: 1) Cake menu is under convection cooking with 325F-preheat function, and you should preheat first following the auto menu operation, when the oven reaches the temperature, it will stop working and sound to remind opening the door to put cake in, then press "**Start / +30 SEC.**" to start cooking.

2) You should use the grill rack when roasting chicken in order to have a better effect of cooking.

Troubleshooting

TROUBLE	POSSIBLE CAUSE	POSSIBLE REMEDY
Oven will not start	<ul style="list-style-type: none"> a. Electrical cord is not plugged in. b. Door is open. c. Wrong operation is set. 	<ul style="list-style-type: none"> a. Plug into the outlet. b. Close the door and try again. c. Check instructions.
Arcing or sparking	<ul style="list-style-type: none"> a. Materials to be avoided in microwave oven were used. b. The oven is operated when empty. c. Spilled food remains in the cavity. 	<ul style="list-style-type: none"> a. Use microwave-safe cookware only. b. Do not operate with oven empty. c. Clean cavity with wet towel.
Unevenly cooked foods	<ul style="list-style-type: none"> a. Materials to be avoided in microwave oven were used. b. Food is not defrosted completely. c. Cooking time, power level is not suitable. d. Food is not turned or stirred. 	<ul style="list-style-type: none"> a. Use microwave-safe cookware only. b. Completely defrost food. c. Use correct cooking time, power level. d. Turn or stir food.
Overcooked foods	<ul style="list-style-type: none"> a. Cooking time, power level is not correct. 	<ul style="list-style-type: none"> Use correct cooking time, power level.
Undercooked foods	<ul style="list-style-type: none"> a. Materials to be avoided in microwave oven were used. b. Food is not defrosted completely. c. Oven ventilation ports are restricted. d. Cooking time, power level is not correct. 	<ul style="list-style-type: none"> a. Use microwave-safe cookware only. b. Completely defrost food. c. Check to see that oven ventilation ports are not restricted. d. Use correct cooking time, power level.
Improper defrosting	<ul style="list-style-type: none"> a. Materials to be avoided in microwave oven were used. b. Cooking time, power level is not correct. c. Food is not turned or stirred. 	<ul style="list-style-type: none"> a. Use microwave-safe cookware only. b. Use correct cooking time, power level. c. Turn or stir food.

CONTOURE™ SPACE SAVER APPLIANCES

CONTOURE Limited Warranty

REGISTER ONLINE. IT'S QUICKY AND EASY! www.ContoureUSA.com

Warranty registration is not mandatory, but doing so will help us to service you more quickly if you need to present a warranty claim. Please go online to complete and return this warranty registration to us.

National Brands LLC. warrants this CONTOURE product ("product") to be free of all defects in material and workmanship for the applicable period specified below commencing from the date of original purchase. This warranty extends to the original buyer only.

Ninety (90) Day Full Warranty: Within ninety (90) days from the date of original purchase, National Brands LLC. in its sole discretion, will either repair or replace, free of charge, any part proving defective in material or workmanship. All warranty repairs and service must be performed at a National Brands LLC. location of service by an authorized National Brands LLC. technician. All expenses related to replacing or repairing a defective part under this ninety (90) day warranty shall be assumed by National Brands LLC., except the cost of transporting the product to and from National Brands LLC., which shall be assumed by the buyer. If the product is replaced, the replacement will be with a product that is identical or equivalent to the warranted product. If the product cannot be repaired or replaced, National Brands LLC. will issue a refund to the buyer for the original purchase price less that amount directly attributable to use by the buyer.

One (1) Year Limited Warranty: After the expiration of the ninety (90) day warranty, and within one (1) year from the date of original purchase, National Brands LLC. will replace any part proving defective in material or workmanship with a product that is identical or equivalent to the warranted part. The buyer shall assume the cost of transporting the defective product to and from National Brands LLC. If the product cannot be replaced, National Brands LLC. will issue a refund to the buyer for the original purchase price less that amount directly attributable to use by the buyer.

Warranty Exclusions: This warranty does not apply to any costs, repairs or services for the following:

- Service calls to correct the installation of the warranty-covered products, to explain the usage of the product to the buyer, or to reset or replace home circuit breakers or fuses
- Repairs necessitated by use other than normal home use
- Damage resulting from misuse, abuse, accidents, alternations, improper installation, fire, flood acts of God or damage caused by the shipping of the product by the buyer to National Brands LLC.
- Corrective work necessitate by repairs made by anyone other than a National Brands LLC. authorized service technician
- Costs incurred for disposing the product at locations other than a National Brands LLC. facility

Hot to Obtain Warranty Service: Upon discovery of any defect, malfunction, or nonconformity in the warranty-covered product, the buyer should visit www.ContoureUSA.com and complete the warranty service request form online.

Notice to Buyer: This warranty gives the buyer specific legal rights, and the buyer may also have other rights which vary from state to state. You have the right to bring any action at law or equity to resolve disputes concerning or to enforce the provisions of this warranty. Every implied warranty, including any statutory warranty or condition of merchantability or fitness for a particular purpose, is disclaimed except to the extent prohibited by law, in which case such warranty or condition is limited to the duration and extent of this written warranty.







Inquiries: If buyer has any questions concerning CONTOURE's product warranty please visit: www.ContoureUSA.com

CONTOURE™

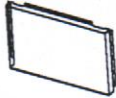
SPACE SAVER APPLIANCES

INSTALLATION INSTRUCTIONS

Model No.:RV-185B-CON

Accessories		
		
DUCT BOTTOM	DUCT UPPER	DUCT BACK
		
TRIM SASH A	TRIM SASH B	
		
SCREW A	SCREW B	

NO.	PART NAME	QTY
1	DUCT BOTTOM	1
2	DUCT UPPER	1
3	DUCT BACK	1
4	TRIM SASH A	2
5	TRIM SASH B	2
6	SCREW A	4
7	SCREW B	6

The dimension of the cabinet should be as belows (FIG.1).

Width : 22.44"(570mm) TOLERANCE $\pm 1/8"$.

Height : 15.14"(384.4mm) TOLERANCE $\pm 1/12"$.

Depth : at least 19.25" (488mm).

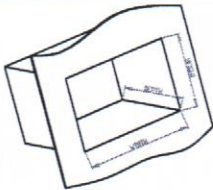

FIG.1

Step 1.ASSEMBLE TRIM SASH

Take out the trim sash from the packing box, and make sure the trim sash A and B are the same showing as the FIG. 2.

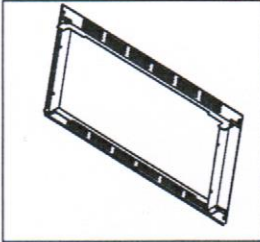

FIG.2

Step 2.CHECK THE TRIM SASH

Take out the microwave oven from packing box, please check the duct upper, duct bottom, duct back if assembled as the showing of FIG3, and fasten the screws.

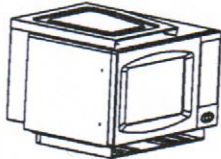

FIG.3

Step 3.TRIM SASH INSTALLATION

Fix assembled TRIM SASH ASSEMBLY to the Oven as shown in FIG.4.

Use SCREW A to fasten the TRIM SASH ASSEMBLY at points indicated in FIG.4.

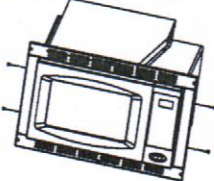

FIG.4

Step 4.MICROWAVE OVEN INSTALLATION

Slide Microwave Oven into the cabinet.

Secure the Oven to the cabinet with SCREW B at points indicated in FIG.5.

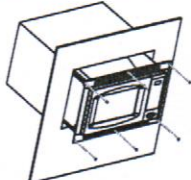

FIG.5