



MOUNTING BRACKET KIT INSTALLATION INSTRUCTIONS

KIT# 1545-1

05/30/12
KS

ROADMASTER, Inc. 6110 NE 127th Ave. Vancouver, WA 98682 1-800-669-9690 fax 360-735-9300 www.roadmasterinc.com

ROADMASTER, INC.

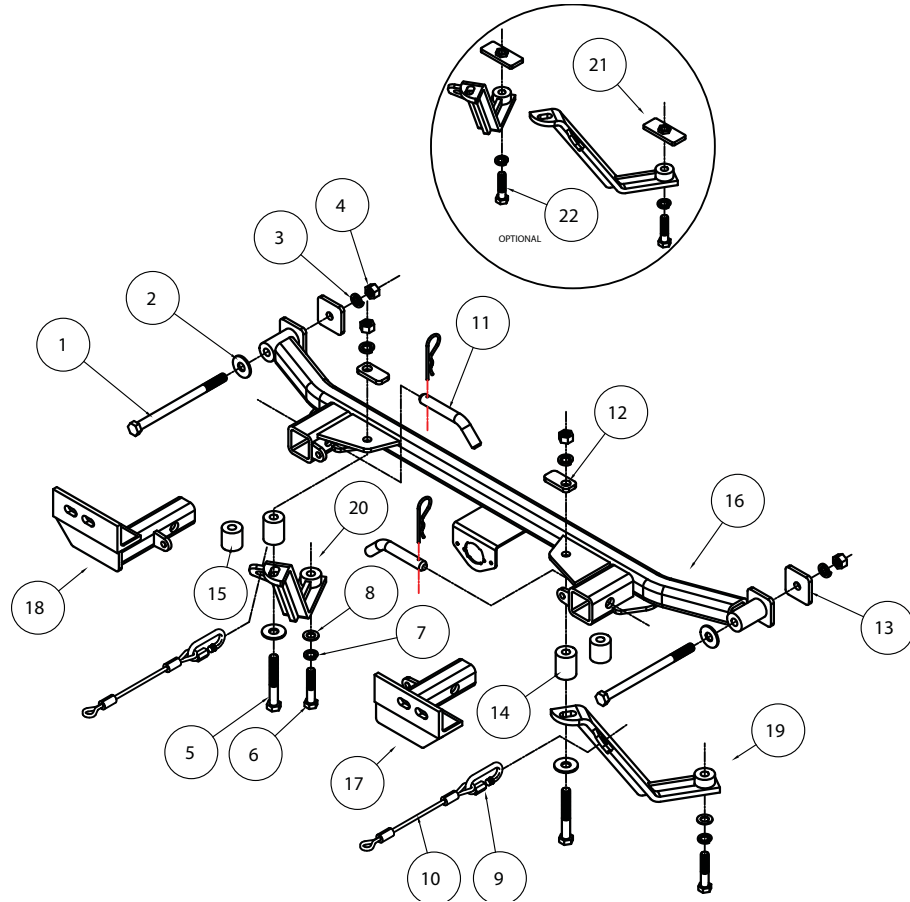

ITEM	QTY	NAME	MATERIAL
1.....	2	1/2" x 7 1/2" BOLT.....	350112-00
2.....	4	1/2" FLAT WASHER.....	350308-00
3.....	6	1/2" LOCK WASHER	350309-00
4.....	4	1/2" HEX NUT	350258-00
5.....	2	1/2" x 3 1/2" BOLT.....	350103-00
6.....	2	12mm x 1.25 x 60mm BOLT	357007-00
7.....	2	12mm LOCK WASHER.....	355725-00
8.....	2	12mm FLAT WASHER.....	355720-00
9.....	2	QUICK LINK.....	200008-00
10.....	2	8" SAFETY CABLE	650646-08
11.....	2	DRAW PIN / SPRING PIN	357035-00
12.....	2	1/4" x 1" x 2" BACKING PLATE	A-000910
13.....	2	1/4" x 2" x 2" BACKING PLATE	A-001066
14.....	2	1 1/4" O.D. x 0.250 x 1 5/8" TUBE SPACER	A-001067
15.....	2	1 1/4" O.D. x 0.250 x 1 1/4" TUBE SPACER	A-000964
16.....	1	MAIN RECEIVER.....	C-000503
17.....	1	DRIVER SIDE ARM.....	C-000504
18.....	1	PASSENGER SIDE ARM	C-000505
19.....	1	DRIVER SIDE BRACE.....	C-000506
20.....	1	PASSENGER SIDE BRACE	C-000507
21.....	2	1/4" x 1 1/4" x 3" THREADED BACKING PLATE	C-000567
22.....	2	1/2" x 2" BOLT.....	350097-00



MOUNTING BRACKET KIT INSTALLATION INSTRUCTIONS

KIT# 1545-1

05/30/12
KS

ROADMASTER, Inc. 6110 NE 127th Ave. Vancouver, WA 98682 1-800-669-9690 fax 360-735-9300 www.roadmasterinc.com

This bracket kit is one of our XL series, which is designed to be partly removable. The kit consists of the main receiver brace, two front arm braces, two lower braces and a hardware pack. The main receiver brace mounts behind the front bumper fascia to the bottom of the bumper core and the front of the frame on each side. The lower braces attach to the front of the radiator support and lower subframe mount on each side. The front arm braces insert into the receivers on each side (Fig.A).

Start by laying the kit out according to the illustration. This will give you a visual idea of how the kit installs and also confirm that all the components are present and accounted for.



IMPORTANT: All brackets **must** be assembled with all the bolts left loose for final adjustment and positioning (before tightening) unless otherwise instructed. All bolts **must** be torqued for proper strength. If more than one bolt is used per fastening point, the diagram may only show one.

- Use flat washers over all slotted holes
- Use lock washers on all fasteners

ROADMASTER Limited Warranty, including One-Year Conditional Warranty Text and Product Registration Card, in Carton.

WARNING

Failure to follow these instructions can result in property damage, personal injury or even death.

- Installation of most mounting brackets requires moderate mechanical aptitude and skills. We strongly recommend professional installation by an experienced installer.
- The installer must read the instructions and use all bolts and parts supplied. Failure to do so could result in loss of the towed vehicle.
- Use Loctite® Red on all bolts used for mounting this bracket.
- Every 3,000 miles, the owner must inspect the fasteners for proper torque, according to the bolt torque requirements chart on the last page of these instructions. The owner must also inspect all mounts and brackets for cracks or other signs of fatigue every 3,000 miles. Failure to do so could result in loss of the towed vehicle.
- The owner must check the vehicle manufacturer's instructions for the proper procedure(s) to prepare the vehicle for towing. Some vehicles must be equipped with a transmission lube pump, an axle disconnect, driveline disconnect or free-wheeling hubs before they can be towed. Failure to properly equip the vehicle will cause severe damage to the transmission.
- If running changes were made by the vehicle manufacturer after this bracket was designed, some bolts or other fasteners in the hardware pack may no longer be the correct size. It is the installer's responsibility to verify that the bracket is securely fastened to the vehicle and fitted with the correct hardware to account for these changes. Failure to securely fasten the bracket could result in loss of the towed vehicle.
- If the towed vehicle has been in an accident, it must be properly repaired before attaching the bracket. Do not install the bracket if any structural frame damage is found. Failure to repair the damage could result in the loss of the towed vehicle.
- Roadmaster manufactures many styles of brackets. If your bracket has removable arms, they must be removed before driving the vehicle, unless the arms can be pinned or padlocked in place. If not secured, the arms could vibrate out, resulting in non-warranty damage or personal injury.
- Some motorhome chassis have such a tight turning radius that you can damage your motorhome, towed vehicle, tow bar or bracket while turning sharply. Before getting on the road, test your turning radius in an empty parking lot. Turning too sharply could result in non-warranty damage to towing system, motorhome and/or towed vehicle.
- Do not back up with the towed vehicle attached or non-warranty damage will occur to your towing system, motorhome and/or towed vehicle.
- The safety cables must connect the towing vehicle to the towed vehicle frame to frame, with the cables crossed, with enough slack for sharp turns. Refer to the cable instructions for proper routing. Failure to leave enough slack in the safety cables, or failure to connect the safety cables frame to frame, will result in the loss of the towed vehicle.
- This bracket is designed for use with ROADMASTER tow bars and ROADMASTER adaptors only. Using this bracket with other brands, without an approved ROADMASTER adaptor, may result in non-warranty damage or injury.
- Do not use this document for custom fabrication, as it may not show all parts or structural components. Custom fabrication or an attempt to copy this bracket design could result in loss of the towed vehicle.
- Upon final installation, the installer must inspect the bracket to ensure adequate clearance, particularly around hoses, air conditioner lines, radiators, etc., or non-warranty damage to the towed vehicle will result.
- This bracket is only warranted for the original installation. Installing a used bracket on another vehicle is not recommended and will void the warranty.



MOUNTING BRACKET KIT INSTALLATION INSTRUCTIONS

KIT# 1545-1

05/30/12
KS

ROADMASTER, Inc. 6110 NE 127th Ave. Vancouver, WA 98682 1-800-669-9690 fax 360-735-9300 www.roadmasterinc.com

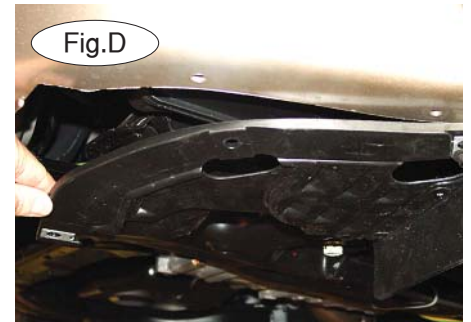

1. **Important:** please use all supplied bolts and parts and read all instructions carefully before beginning this installation. The majority of questions you may have can be answered within the text, and proper installation will ensure safe and secure travel. Now, begin the installation. Remove the ten plastic fasteners holding the top black plastic grille cover on the top of the fascia and set the cover aside (Fig.B). *Note:* some models will not have a grille cover, and the fastener count will differ.

2. Move to the junction of the fenders and the fascia and remove a Phillips head screw (Fig.C) on each side then two lower 10mm (head) fasteners and a plastic snap fastener (Fig.D). Remove four more plastic fasteners in the bottom of the fascia and pull forward to remove. *Note:* the fascia fits into clips under and around the headlights and will take a sharp tug to remove (Fig.E).

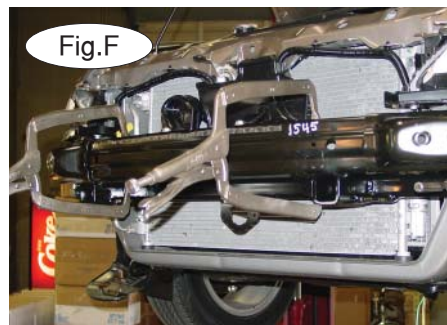

3. Hold the main receiver brace to the bottom of the bumper core against the front of the frame on each side and clamp in place as pictured. Make certain the brace is centered and snug against the front of the frame (Fig.F). *Note:* some vehicles may have an ambient air sensor, which can be displaced to clear the brace as shown (Fig.G).

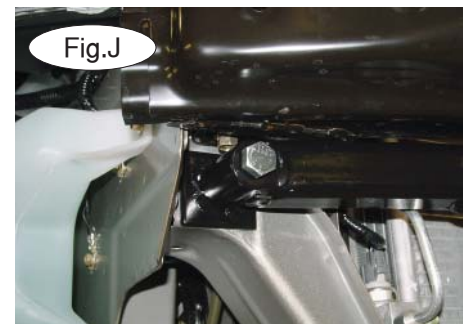
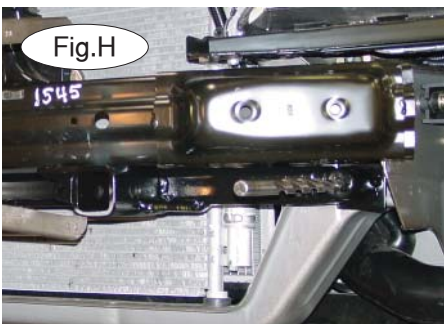

4. Using the receiver brace as a template drill a hole through the front of the frame on each side (Fig.H).
5. Bolt through the frames with $\frac{1}{2}$ " x $7\frac{1}{2}$ " bolts, flat washers, $\frac{1}{4}$ " x 2" x 2" backing plates, lock washers and nuts (Fig.I,J). Tighten these bolts.



MOUNTING BRACKET KIT INSTALLATION INSTRUCTIONS

KIT# 1545-1

05/30/12
KS

ROADMASTER, Inc. 6110 NE 127th Ave. Vancouver, WA 98682 1-800-669-9690 fax 360-735-9300 www.roadmasterinc.com

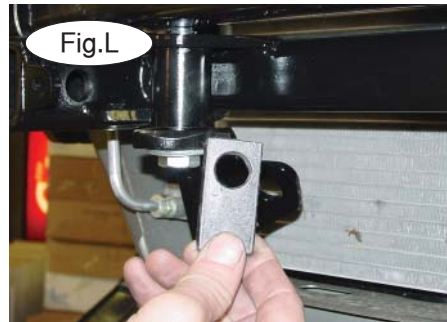
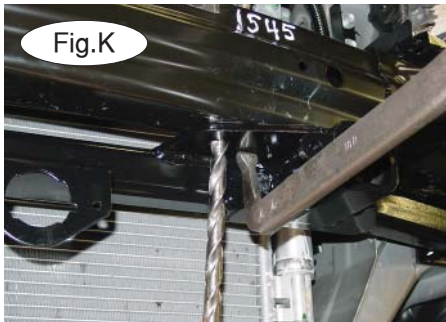

6. Now, using the receiver brace as a drill template again, drill two holes through the bottom of the bumper core (Fig.K).
7. Insert two $\frac{1}{4}$ " x 1" x 2" backing plates into the bumper core over the drilled holes (Fig.L).

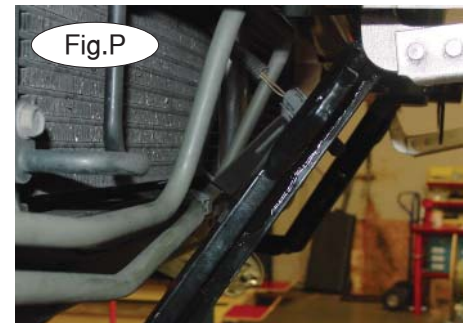
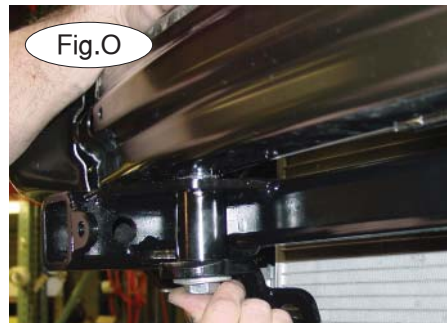

8. Remove the front inside 17mm (head) bolt from the subframe mount on each side (Fig.M). *Note* : some models don't have the subframe brace or bolt. If this is the case, place a piece of metal between the radiator and cross member to protect the engine components and ream the existing hole to $\frac{1}{2}$ ". Place the optional $\frac{1}{4}$ " x $1\frac{1}{4}$ " x 3" threaded backing plate on the top side of the lower brace and use the optional included $\frac{1}{2}$ " x 2" bolts to bolt up through the lower brace and into the threaded backing plate.

9. Hold the lower braces for each side over these mounting holes as illustrated and bolt into place with 12mm x 1.25 x 60mm bolts, lock washers, and flat washers (Fig.N). Bolt through the tops of the bottom braces, $1\frac{5}{8}$ " or $1\frac{1}{4}$ " spacers, the receiver brace and the bottom of the bumper core and the backing plates with $\frac{1}{2}$ " x $3\frac{1}{2}$ " bolts, lock washers and nuts (Fig.O). *Note*: some models will require displacing the power steering cooling line slightly to clear the lower braces (Fig.P). Some models will require different length tube spacers.

10. Torque all bolts to the bolt torque requirements found at the end of these instructions.

11. Replace the bumper foam and trial fit the fascia. Mark the trim areas around the lower brace then remove and trim (Fig.Q).

12. Trim the lower center splash panel to fit around the lower braces (Fig.R), then reinstall the fascia reversing steps 2 and 3. Additional minor trimming in the grille may be required on some models.





MOUNTING BRACKET KIT INSTALLATION INSTRUCTIONS

KIT# 1545-1

05/30/12
KS

ROADMASTER, Inc. 6110 NE 127th Ave. Vancouver, WA 98682 1-800-669-9690 fax 360-735-9300 www.roadmasterinc.com

- 13. **2006-2007 models** require trimming on the inside edge of the grille above the receiver (Fig.S).
- 14. Insert the front braces into the receiver tubes and pin with 5/8" draw pins and spring pins.
- 15. Install the tow bar according to the manufacturer's instructions.
- 16. Attach one end of the 8" safety cables to front holes on the receiver cross bar on each side of the receiver brace with the included cable connectors. Connect the other end to the tow vehicle's safety cables and tow bar.

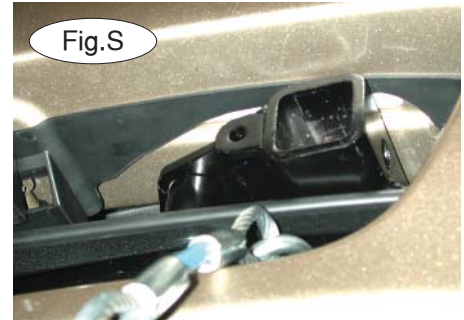

BOLT TORQUE REQUIREMENTS

Note: The torque values represented below are intended as general guidelines. Torque requirements for specific applications may vary. Roadmaster does not warrant this information to be accurate for all applications and disclaims all liability for any claims or damages which may result from its use.

STANDARD BOLTS

Thread Size	Grade	Torque
5/16.....	5.....	13 ft./lb.
3/8.....	5.....	23 ft./lb.
7/16.....	5.....	37 ft./lb.
1/2.....	5.....	56 ft./lb.
5/8.....	5.....	150 ft./lb.

METRIC BOLTS

Thread Size	Grade	Plated / Unplated
8mm-1.0	8.8	20 ft./lb. 18 ft./lb.
8mm-1.25	8.8	19 ft./lb. 18 ft./lb.
10mm-1.25	8.8	38 ft./lb. 36 ft./lb.
10mm-1.5	8.8	37 ft./lb. 35 ft./lb.

METRIC BOLTS

Thread Size	Grade	Plated / Unplated
12mm-1.25	8.8	70 ft./lb. 65 ft./lb.
12mm-1.5	8.8	66 ft./lb. 61 ft./lb.
12mm-1.75	8.8	65 ft./lb. 60 ft./lb.
14mm-2.0	8.8	104 ft./lb. 97 ft./lb.

All illustrations and specifications contained herein are based on the latest information available at the time of publication approval. ROADMASTER, INC. reserves the right to make changes at any time without notice in material, specification and models or to discontinue models.