



MOUNTING BRACKET KIT INSTALLATION INSTRUCTIONS

KIT# 4427-1A

05/26/15
KS

ROADMASTER, Inc. 6110 NE 127th Ave. Vancouver, WA 98682 360-896-0407 fax 360-735-9300 www.roadmasterinc.com

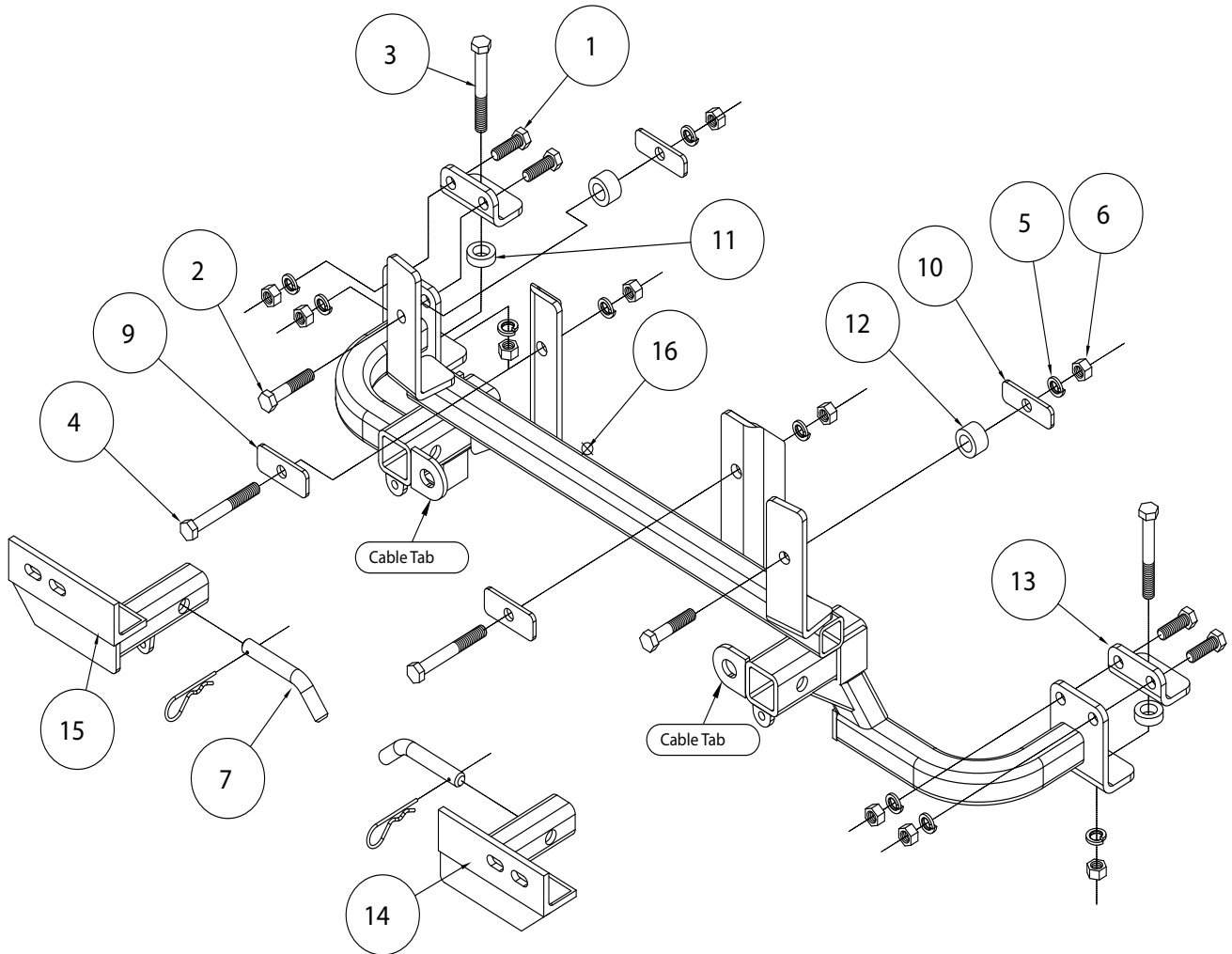

ITEM	QTY	NAME	MATERIAL
1.....	4	1/2" x 1 1/2" BOLT	350095-00
2.....	2	1/2" x 2 1/2" BOLT	350099-00
3.....	2	1/2" x 4" BOLT	350105-00
4.....	2	1/2" x 3 1/2" BOLT	350103-00
5.....	10	1/2" LOCK WASHER	350309-00
6.....	10	1/2" HEX NUT	350258-00
7.....	2	5/8" DRAW PIN W/ CLIP	357035-00
8.....	2	ZIP TIE	300140-10
9.....	2	3/16" x 1 1/4" x 3" BACKING PLATE	A-000317
10.....	2	3/16" x 1" x 3" BACKING PLATE	A-003641
11.....	2	1 1/4" O.D. x 0.25 WALL x 3/8" PIPE SPACER	A-001869
12.....	2	1 1/4" O.D. x 0.25 WALL x 3/4" PIPE SPACER	A-003673
13.....	2	5/16" x 3 1/8" x 3 1/4" BACKING PLATE	B-001754
14.....	1	DRIVER SIDE ARM	C-002204
15.....	1	PASSENGER SIDE ARM	C-002205
16.....	1	MAIN RECEIVER BRACE	C-002206



MOUNTING BRACKET KIT INSTALLATION INSTRUCTIONS

KIT# 4427-1A

05/26/15
KS

ROADMASTER, Inc. 6110 NE 127th Ave. Vancouver, WA 98682 360-896-0407 fax 360-735-9300 www.roadmasterinc.com

This is one of our XL series brackets, which allows the visible front portion of the bracket to be easily removed from the front of the vehicle (Fig.A and Fig.B). The bracket consists of a main receiver brace, two removable front braces, and a hardware pack.

The main receiver brace mounts to the frame rails and the bumper core. The removable front braces install in the main receiver brace.

Before starting the installation, lay out the kit components in order, as they will be used. This will give you a visual idea of how the components work, and will also confirm that everything is present and accounted for.



Fig.A



Fig.B

IMPORTANT: All brackets *must* be assembled with all the bolts left loose for final adjustment and positioning (before tightening) unless otherwise instructed. All bolts *must* be torqued for proper strength. If more than one bolt is used per fastening point, the diagram may only show one.

- Use flat washers over all slotted holes
- Use lock washers on all fasteners

ROADMASTER Limited Warranty, including One-Year Conditional Warranty Text and Product Registration Card, in Carton.

WARNING

Failure to follow these instructions can result in property damage, personal injury or even death.

- Installation of most mounting brackets requires moderate mechanical aptitude and skills. We strongly recommend professional installation by an experienced installer.
- The installer must read the instructions and use all bolts and parts supplied. Failure to do so could result in loss of the towed vehicle.
- Use Loctite® Red on all bolts used for mounting this bracket.
- Every 3,000 miles, the owner must inspect the fasteners for proper torque, according to the bolt torque requirements chart on the last page of these instructions. The owner must also inspect all mounts and brackets for cracks or other signs of fatigue every 3,000 miles. Failure to do so could result in loss of the towed vehicle.
- The owner must check the vehicle manufacturer's instructions for the proper procedure(s) to prepare the vehicle for towing. Some vehicles must be equipped with a transmission lube pump, an axle disconnect, driveline disconnect or free-wheeling hubs before they can be towed. Failure to properly equip the vehicle will cause severe damage to the transmission.
- If running changes were made by the vehicle manufacturer after this bracket was designed, some bolts or other fasteners in the hardware pack may no longer be the correct size. It is the installer's responsibility to verify that the bracket is securely fastened to the vehicle and fitted with the correct hardware to account for these changes. Failure to securely fasten the bracket could result in loss of the towed vehicle.
- If the towed vehicle has been in an accident, it must be properly repaired before attaching the bracket. Do not install the bracket if any structural frame damage is found. Failure to repair the damage could result in the loss of the towed vehicle.
- Roadmaster manufactures many styles of brackets. If your bracket has removable arms, they must be removed before driving the vehicle, unless the arms can be pinned or padlocked in place. If not secured, the arms could vibrate out, resulting in non-warranty damage or personal injury.
- Some motorhome chassis have such a tight turning radius that you can damage your motorhome, towed vehicle, tow bar or bracket while turning sharply. Before getting on the road, test your turning radius in an empty parking lot. Turning too sharply could result in non-warranty damage to towing system, motorhome and/or towed vehicle.
- Do not back up with the towed vehicle attached or non-warranty damage will occur to your towing system, motorhome and/or towed vehicle.
- The safety cables must connect the towing vehicle to the towed vehicle frame to frame, with the cables crossed, with enough slack for sharp turns. Refer to the cable instructions for proper routing. Failure to leave enough slack in the safety cables, or failure to connect the safety cables frame to frame, will result in the loss of the towed vehicle.
- This bracket is designed for use with ROADMASTER tow bars and ROADMASTER adaptors only. Using this bracket with other brands, without an approved ROADMASTER adaptor, may result in non-warranty damage or injury.
- Do not use this document for custom fabrication, as it may not show all parts or structural components. Custom fabrication or an attempt to copy this bracket design could result in loss of the towed vehicle.
- Upon final installation, the installer must inspect the bracket to ensure adequate clearance, particularly around hoses, air conditioner lines, radiators, etc., or non-warranty damage to the towed vehicle will result.
- This bracket is only warranted for the original installation. Installing a used bracket on another vehicle is not recommended and will void the warranty.



MOUNTING BRACKET KIT INSTALLATION INSTRUCTIONS

KIT# 4427-1A

05/26/15
KS

ROADMASTER, Inc. 6110 NE 127th Ave. Vancouver, WA 98682 360-896-0407 fax 360-735-9300 www.roadmasterinc.com



1. **Important:** please use all supplied bolts and parts and read all instructions carefully before beginning this installation. The majority of questions you may have can be answered within the text, and proper installation will ensure safe and secure travel. Now, begin the installation. Remove seven 10mm (head) bolts and two plastic fasteners attaching the upper fascia to the fascia (Fig.C).

2. On each side, remove six Phillips screws attaching the fender liner to the fascia. *Note:* four screws are on the outside, attaching the fender liner and fender flare to the fascia (Fig.D) and two are under the fender flare, attaching the fascia to the fender (Fig.E). *Note:* due to manufacturing variances, the hardware may be 5.5mm (head) screws.

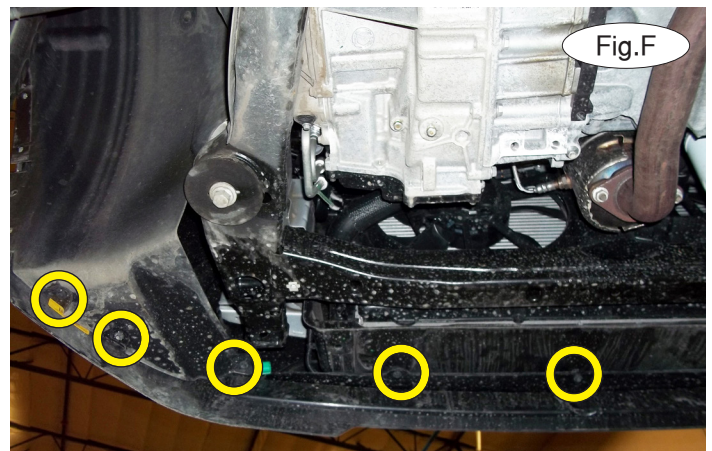

3. Remove nine 8mm (head) bolts attaching the fascia to the core support and fender liner. *Note:* Figure F shows the three driver's side bolts and two center bolts only.

4. Pull out and forward on the corners of the fascia to remove it (Fig.G). *Note:* unplug the fog lights and parking sensors, if the vehicle is so equipped.





MOUNTING BRACKET KIT INSTALLATION INSTRUCTIONS

KIT# 4427-1A

05/26/15
KS

ROADMASTER, Inc. 6110 NE 127th Ave. Vancouver, WA 98682 360-896-0407 fax 360-735-9300 www.roadmasterinc.com

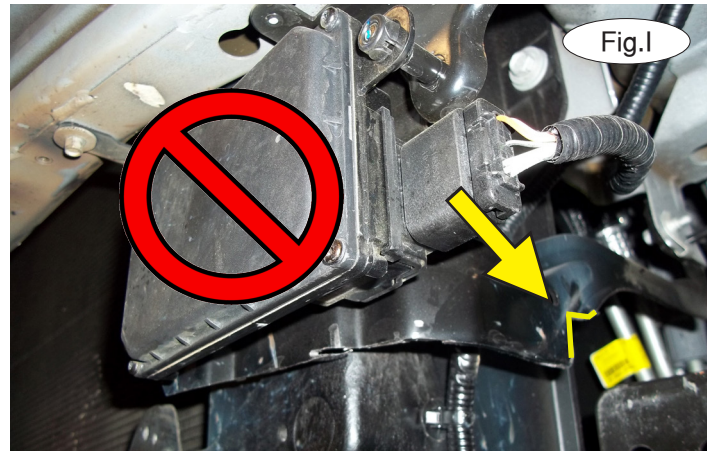
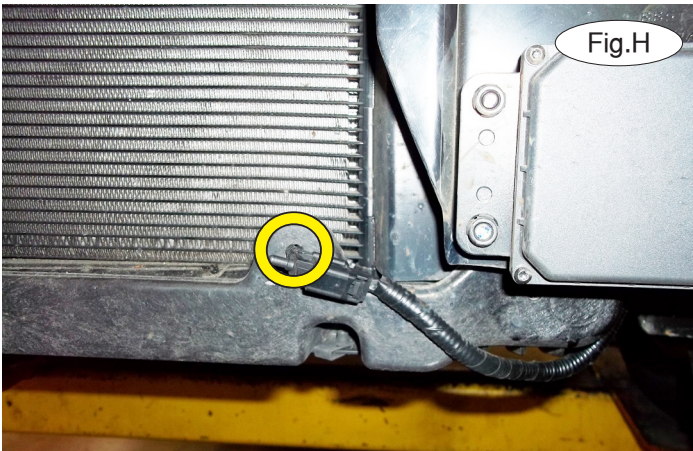

5. Disconnect the ambient temperature sensor by removing one plastic fastener (Fig.H), if the vehicle is so equipped.



6. **For models without Active Cruise Control:** proceed to step 7. **For models with Active Cruise Control:** using a cut-off wheel or reciprocating saw, trim the ACC mounting bracket to allow clearance for the main receiver brace. Use the yellow lines in Figure I as a guide for trimming. **Caution! Under no circumstances should you attempt to move, adjust or disconnect the ACC unit (indicated in red in Figure I). Doing so may cause cruise control malfunction and/or computer error codes that may require the dealership to repair or reset.**

7. Locate the four existing holes in the bumper core and using a die grinder, enlarge the outside hole on each side (Fig.J – passenger side).

8. Place one of the supplied $\frac{3}{16}$ " x $1\frac{1}{4}$ " x 3" backing plates over the supplied $\frac{1}{2}$ " x $\frac{1}{2}$ " bolt. Slide the main receiver brace over the bumper core, aligning the front and rear mounting points with the four holes in the bumper core and then insert the $\frac{1}{2}$ " x $3\frac{1}{2}$ " bolts through the bumper core and into the main receiver brace and finish with a $\frac{1}{2}$ " lock washer and nut (Fig.K). *Note: use Loctite® Red on each bolt used in this installation.*

9. On each side, place one of the supplied $1\frac{1}{4}$ " x $\frac{3}{4}$ " pipe spacers between the front upper mounting point of the main receiver brace and bumper core (Fig.L).





MOUNTING BRACKET KIT INSTALLATION INSTRUCTIONS

KIT# 4427-1A

05/26/15
KS

ROADMASTER, Inc. 6110 NE 127th Ave. Vancouver, WA 98682 360-896-0407 fax 360-735-9300 www.roadmasterinc.com

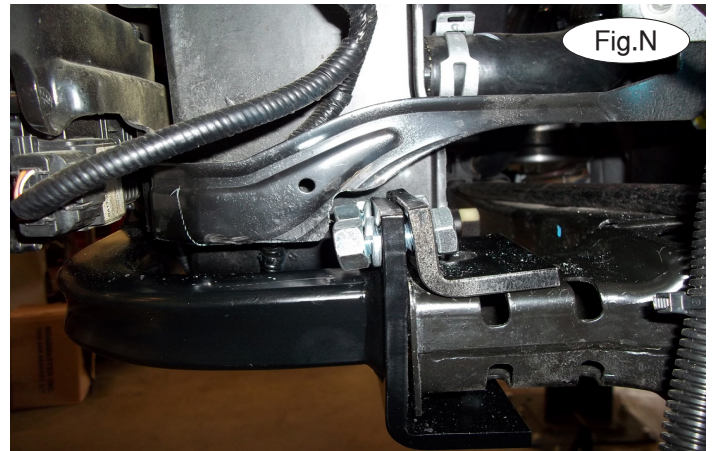

10. Using two of the supplied $\frac{1}{2}$ " x $2\frac{1}{2}$ " bolts, bolt through the front upper mounting point of the main receiver brace, pipe spacer and bumper core (Fig.M – passenger side). Finish with a $\frac{1}{2}$ " lock washer and nut.

11. On each side, place one of the formed backing plates over the top of the subframe, aligning the holes with the holes in the main receiver brace. Bolt it to the main receiver brace using the two supplied $\frac{1}{2}$ " x $1\frac{1}{2}$ " bolts (Fig.N – driver's side). Make certain that the air conditioning line is not contacting the rear mounting point of the main receiver brace. If it is, bend it slightly out of the way (Fig.O – passenger side).

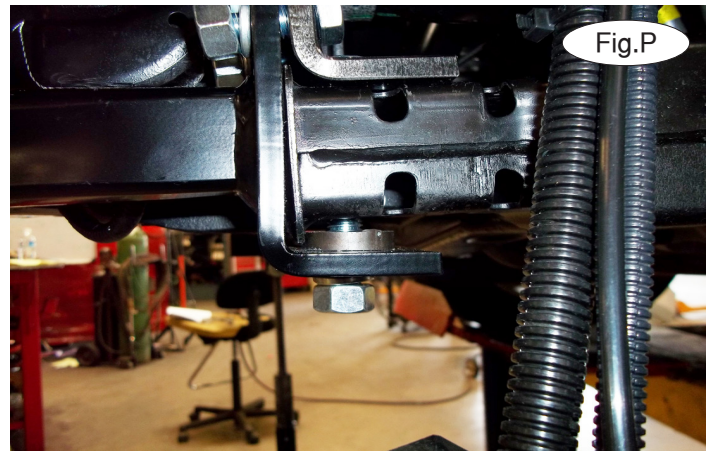
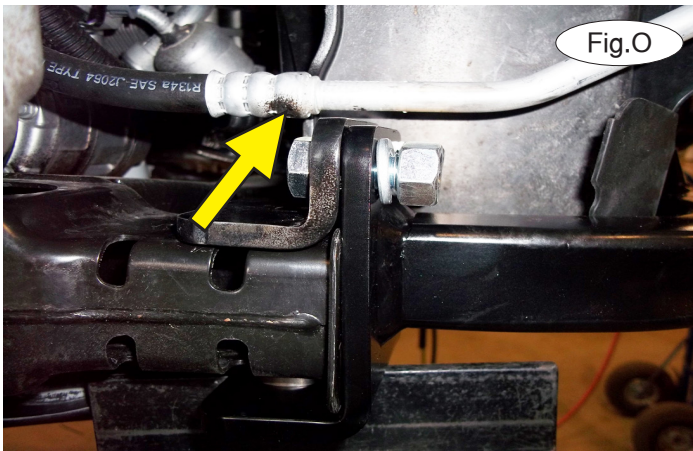

12. On each side, place one of the supplied $1\frac{1}{4}$ " x $\frac{3}{8}$ " pipe spacers between the lower mounting point of the main receiver brace and the end of the subframe. Using one of the supplied $\frac{1}{2}$ " x 4" bolts, bolt down through the formed backing plate, subframe, pipe spacer and main receiver brace. Finish with a $\frac{1}{2}$ " lock washer and nut (Fig.P – driver's side).

13. Torque all the bolts to the bolt torque specifications found at the end of these instructions. Zip tie the ambient temperature sensor to the main receiver brace (Fig.Q).





MOUNTING BRACKET KIT INSTALLATION INSTRUCTIONS

KIT# 4427-1A

05/26/15
KS

ROADMASTER, Inc. 6110 NE 127th Ave. Vancouver, WA 98682 360-896-0407 fax 360-735-9300 www.roadmasterinc.com



14. Hold the fascia in place and mark the grille for trimming. Use the yellow lines in Figure R as a reference for trimming.
15. Reinstall the fascia, reversing steps 1 through 4.
16. Insert the removable front bracket arms into the front receiver braces, and secure them in place with the supplied 5/8" draw pins and spring pins.
17. Install the tow bar to the mounting bracket according to the manufacturer's instructions. Attach the ends of the safety cables to the tow vehicle's safety cables and tow bar.

IMPORTANT!

Safety cables are required by law. When towing, connect safety cables to the safety cable tabs shown in Figure S. Make certain there is adequate slack in the cables to allow a full turning radius; otherwise, damage will result. If necessary, longer cables or cable extensions are available.

Note: if the bracket is so equipped, the holes in the alignment tabs which are welded to the arms and main receivers are for padlocks only. Under no circumstances should you bolt the alignment tabs together. Bolting the alignment tabs together may result in non-warranty damage to the bracket.

BOLT TORQUE REQUIREMENTS

Note: The torque values represented below are intended as general guidelines. Torque requirements for specific applications may vary. Roadmaster does not warrant this information to be accurate for all applications and disclaims all liability for any claims or damages which may result from its use.

STANDARD BOLTS

Thread Size	Grade	Torque
5/16.....	5.....	13 ft./lb.
3/8.....	5.....	23 ft./lb.
7/16.....	5.....	37 ft./lb.
1/2.....	5.....	56 ft./lb.
5/8.....	5.....	150 ft./lb.

METRIC BOLTS

Thread Size	Grade	Plated / Unplated
8mm-1.0	8.8	20 ft./lb. 18 ft./lb.
8mm-1.25	8.8	19 ft./lb. 18 ft./lb.
10mm-1.25	8.8	38 ft./lb. 36 ft./lb.
10mm-1.5	8.8	37 ft./lb. 35 ft./lb.

METRIC BOLTS

Thread Size	Grade	Plated / Unplated
12mm-1.25	8.8	70 ft./lb. 65 ft./lb.
12mm-1.5	8.8	66 ft./lb. 61 ft./lb.
12mm-1.75	8.8	65 ft./lb. 60 ft./lb.
14mm-2.0	8.8	104 ft./lb. 97 ft./lb.

All illustrations and specifications contained herein are based on the latest information available at the time of publication approval. ROADMASTER, INC. reserves the right to make changes at any time without notice in material, specification and models or to discontinue models.