



MOUNTING BRACKET KIT INSTALLATION INSTRUCTIONS

KIT# 521567-1

12/08/14
KS

ROADMASTER, Inc. 6110 NE 127th Ave. Vancouver, WA 98682 360-896-0407 fax 360-735-9300 www.roadmasterinc.com

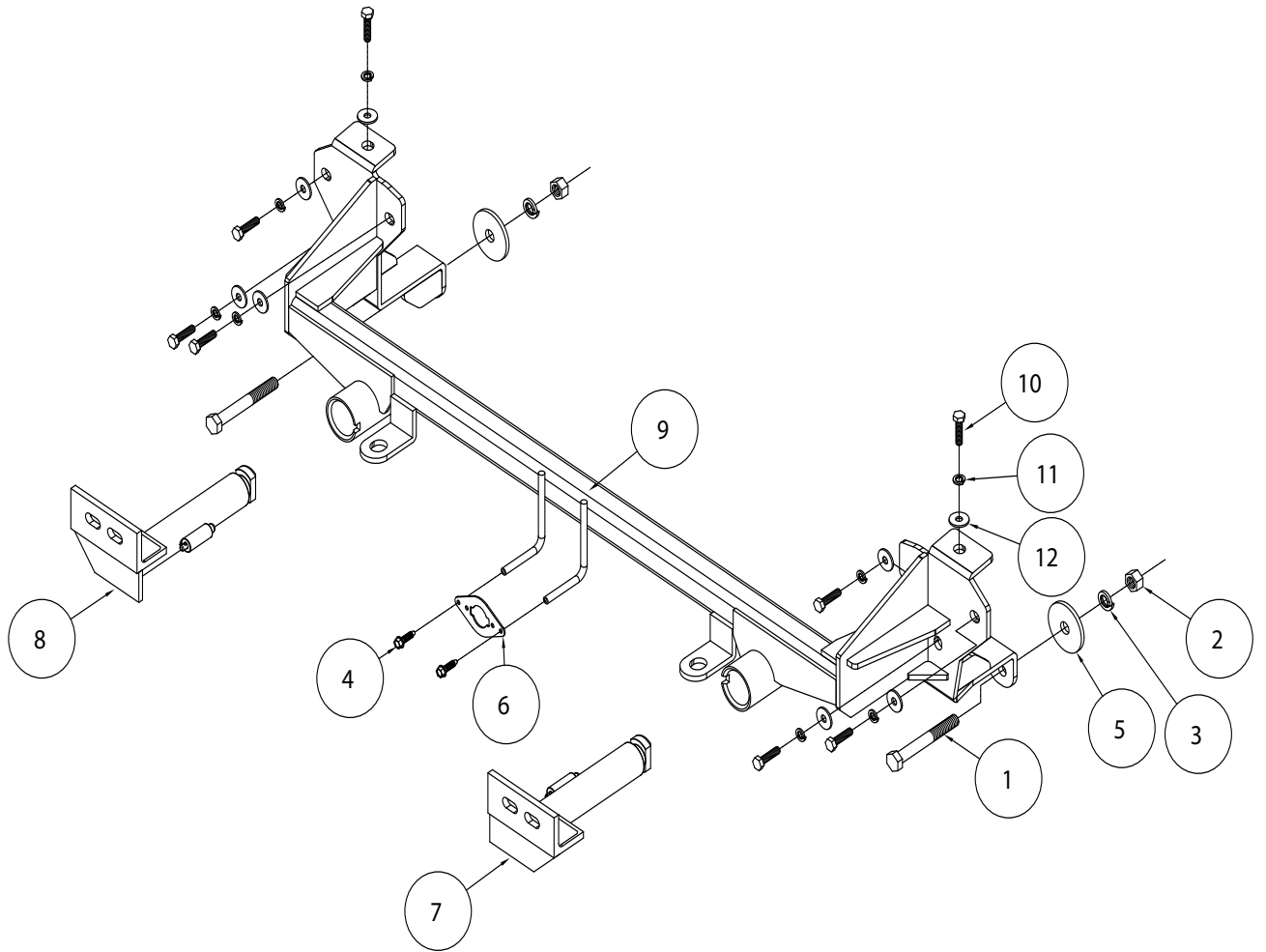

ITEM	QTY	NAME	MATERIAL
1	2	1/2" x 4 1/2" BOLT	350106-00
2	2	1/2" HEX NUT	350258-00
3	2	1/2" LOCK WASHER	350309-00
4	2	#10 x 3/4" SELF TAPPING SCREW	350247-35
5	2	1/2" PLATE WASHER	A-003086
6	1	WIRE PLUG PLATE	A-003801
7	1	DRIVER SIDE ARM	C-002386
8	1	PASSENGER SIDE ARM	C-002387
9	1	MAIN RECEIVER	C-002385
10	8	8mm x 1.25 x 30mm BOLT	356001-00
11	8	8mm LOCK WASHER	355705-00
12	8	5/16" FLAT WASHER	350302-00



MOUNTING BRACKET KIT INSTALLATION INSTRUCTIONS

KIT# 521567-1

12/08/14
KS

ROADMASTER, Inc. 6110 NE 127th Ave. Vancouver, WA 98682 360-896-0407 fax 360-735-9300 www.roadmasterinc.com

This is one of our EZ4 series brackets, which allows the visible front portion of the bracket to be easily removed from the front of the vehicle (Fig.A and Fig.B). The bracket consists of a main receiver brace, two removable front braces, and a hardware pack.

The main receiver brace mounts to the frame rails and the removable front braces install in the main receiver brace.

Before starting the installation, lay out the kit components in order, as they will be used. This will give you a visual idea of how the components work, and will also confirm that everything is present and accounted for.



Fig.A



Fig.B

IMPORTANT: All brackets *must* be assembled with all the bolts left loose for final adjustment and positioning (before tightening) unless otherwise instructed. All bolts *must* be torqued for proper strength. If more than one bolt is used per fastening point, the diagram may only show one.

- Use flat washers over all slotted holes
- Use lock washers on all fasteners

ROADMASTER Limited Warranty, including One-Year Conditional Warranty Text and Product Registration Card, in Carton.

WARNING

Failure to follow these instructions can result in property damage, personal injury or even death.

- **Installation of most mounting brackets requires moderate mechanical aptitude and skills.** We strongly recommend professional installation by an experienced installer.
- **The installer must read the instructions and use all bolts and parts supplied.** Failure to do so could result in loss of the towed vehicle.
- **Use Loctite® Red** on all bolts used for mounting this bracket.
- **Every 3,000 miles, the owner must inspect the fasteners** for proper torque, according to the bolt torque requirements chart on the last page of these instructions. **The owner must also inspect all mounts and brackets for cracks or other signs of fatigue every 3,000 miles.** Failure to do so could result in loss of the towed vehicle.
- **The owner must check the vehicle manufacturer's instructions for the proper procedure(s) to prepare the vehicle for towing.** Some vehicles must be equipped with a transmission lube pump, an axle disconnect, driveline disconnect or free-wheeling hubs before they can be towed. Failure to properly equip the vehicle will cause severe damage to the transmission.
- **If running changes were made** by the vehicle manufacturer after this bracket was designed, some bolts or other fasteners in the hardware pack may no longer be the correct size. **It is the installer's responsibility** to verify that the bracket is securely fastened to the vehicle and fitted with the correct hardware to account for these changes. Failure to securely fasten the bracket could result in loss of the towed vehicle.
- If the towed vehicle has been in an accident, it must be properly repaired before attaching the bracket. **Do not install the bracket if any structural frame damage is found.** Failure to repair the damage could result in the loss of the towed vehicle.
- Roadmaster manufactures many styles of brackets. **If your bracket has removable arms, they must be removed before driving the vehicle, unless the arms can be pinned or padlocked in place.** If not secured, the arms could vibrate out, resulting in non-warranty damage or personal injury.
- Some motorhome chassis have such a tight turning radius that you can damage your motorhome, towed vehicle, tow bar or bracket while turning sharply. **Before getting on the road, test your turning radius in an empty parking lot.** Turning too sharply could result in non-warranty damage to towing system, motorhome and/or towed vehicle.
- **Do not back up with the towed vehicle attached** or non-warranty damage will occur to your towing system, motorhome and/or towed vehicle.
- **The safety cables must connect the towing vehicle to the towed vehicle frame to frame, with the cables crossed, with enough slack for sharp turns.** Refer to the cable instructions for proper routing. Failure to leave enough slack in the safety cables, or failure to connect the safety cables frame to frame, will result in the loss of the towed vehicle.
- This bracket is designed for use with ROADMASTER tow bars and ROADMASTER adaptors only. **Using this bracket with other brands, without an approved ROADMASTER adaptor, may result in non-warranty damage or injury.**
- **Do not use this document for custom fabrication,** as it may not show all parts or structural components. Custom fabrication or an attempt to copy this bracket design could result in loss of the towed vehicle.
- Upon final installation, **the installer must inspect the bracket to ensure adequate clearance, particularly around hoses, air conditioner lines, radiators, etc.,** or non-warranty damage to the towed vehicle will result.
- **This bracket is only warranted for the original installation.** Installing a used bracket on another vehicle is not recommended and will void the warranty.



MOUNTING BRACKET KIT INSTALLATION INSTRUCTIONS

KIT# 521567-1

12/08/14
KS

ROADMASTER, Inc. 6110 NE 127th Ave. Vancouver, WA 98682 360-896-0407 fax 360-735-9300 www.roadmasterinc.com

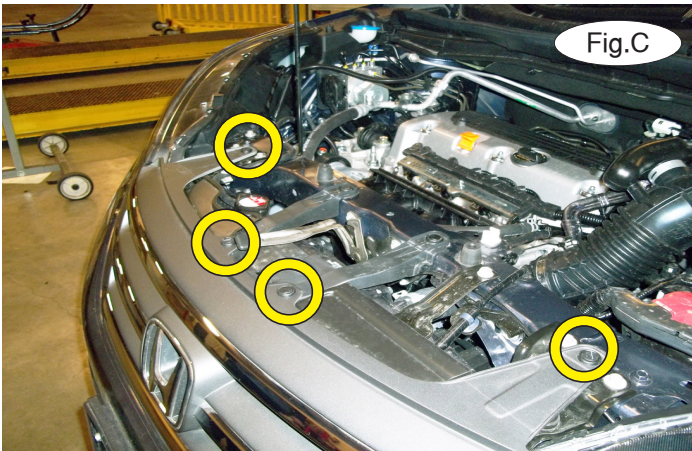

1. **Important:** please use all supplied bolts and parts and read all instructions carefully before beginning this installation. The majority of questions you may have can be answered within the text, and proper installation will ensure safe and secure travel. Now, begin the installation. Remove four plastic fasteners attaching the grille to the radiator support (Fig.C).

2. On each side, remove one 10mm (head) bolt and one plastic fastener attaching the bottom of the fascia to the fender liner (Fig.D). Now, remove four plastic fasteners attaching the fascia to the splash shield (Fig.E).



3. On each side, remove one Philips screw and two plastic fasteners from the inside of the fender liner (Fig.F).

4. On each side, pull back the fender liner and remove one plastic fastener attaching the lower trim to the fascia (Fig.G).





MOUNTING BRACKET KIT INSTALLATION INSTRUCTIONS

KIT# 521567-1

12/08/14
KS

ROADMASTER, Inc. 6110 NE 127th Ave. Vancouver, WA 98682 360-896-0407 fax 360-735-9300 www.roadmasterinc.com



5. On each side, carefully pull the lower fascia from the fender trim (Fig.H), and the fender trim from the fender (Fig.I), releasing three clips.

6. On each side, remove one Philips screw from the corner of the fascia (Fig.J).



7. With a firm grip on the grille, pull hard and straight out on it to release it from the two yellow clips near the headlights and the four yellow clips along the bottom of the grille (Fig.K). On each side, pull out on corner of the fascia to remove it from the locking strip as indicated by the yellow lines in Figure L) and then a screwdriver to release the yellow clip shown in Figure M.

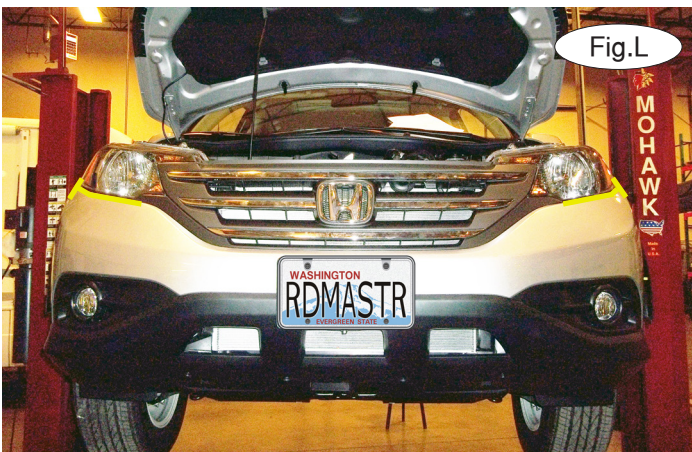



MOUNTING BRACKET KIT INSTALLATION INSTRUCTIONS

KIT# 521567-1

12/08/14
KS

ROADMASTER, Inc. 6110 NE 127th Ave. Vancouver, WA 98682 360-896-0407 fax 360-735-9300 www.roadmasterinc.com

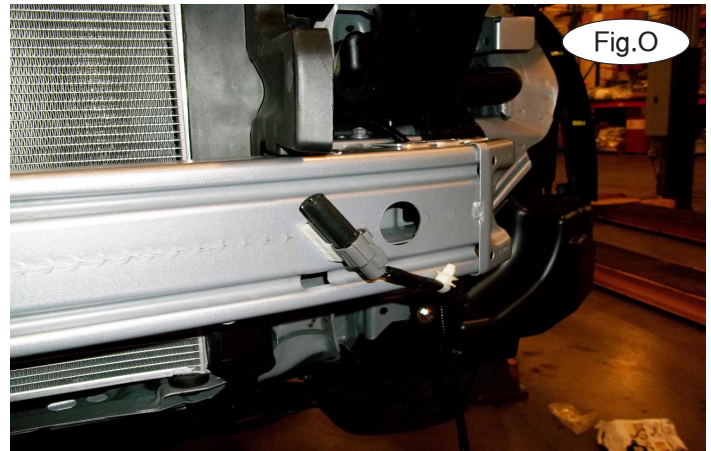
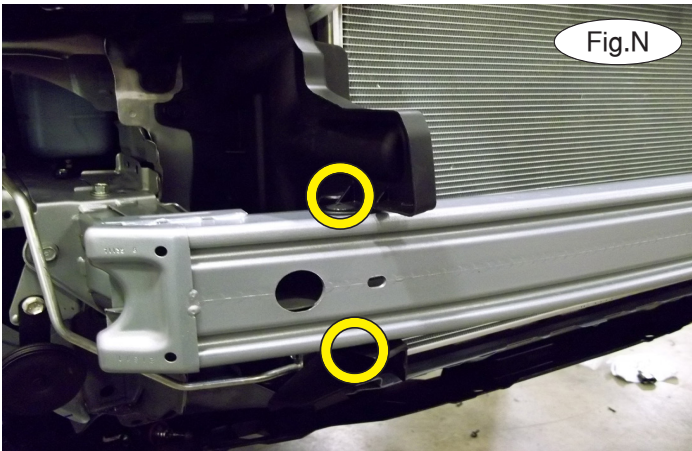

8. Now, pull out and forward to remove the fascia. Disconnect the fog lights, if the vehicle is so equipped.

9. Remove two clips attaching the passenger side air dam to the bumper core (Fig.N) and one attaching the driver's side air dam.

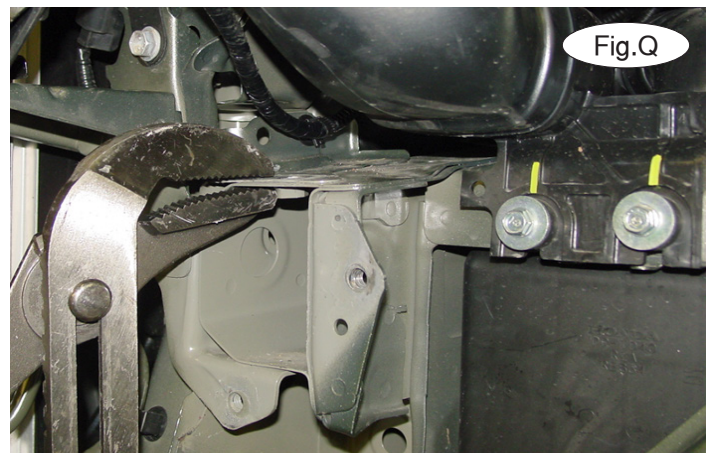
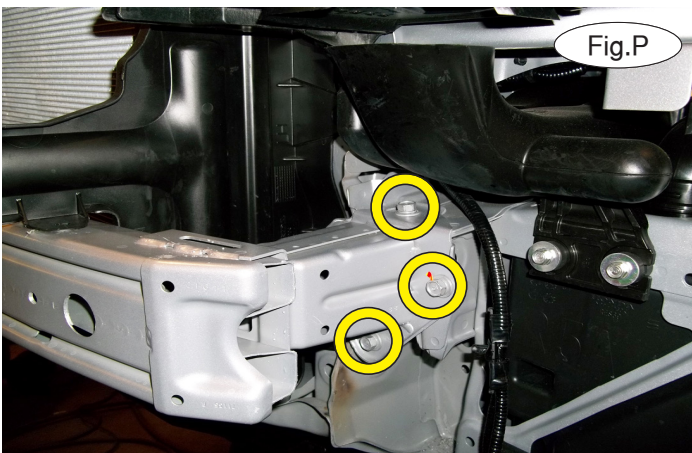

10. Disconnect the ambient temperature sensor from the bumper core (Fig.O). Let it hang down for now.

11. On each side, remove four 12mm (head) bolts attaching the bumper core to the frame (Fig.P). *Note:* only three are shown. The fourth bolt is to the inside of the frame rail.

Now, remove the bumper core. The bumper core will not be replaced. *Note:* retain the bumper core and attachment hardware for replacement in case the bracket is ever removed.

12. On each side, use a pair of channel locks to bend flush the tab located on the top of the frame rail to allow clearance for the main receiver brace (Fig.Q).



MOUNTING BRACKET KIT INSTALLATION INSTRUCTIONS

KIT# 521567-1

12/08/14
KS

ROADMASTER, Inc. 6110 NE 127th Ave. Vancouver, WA 98682 360-896-0407 fax 360-735-9300 www.roadmasterinc.com

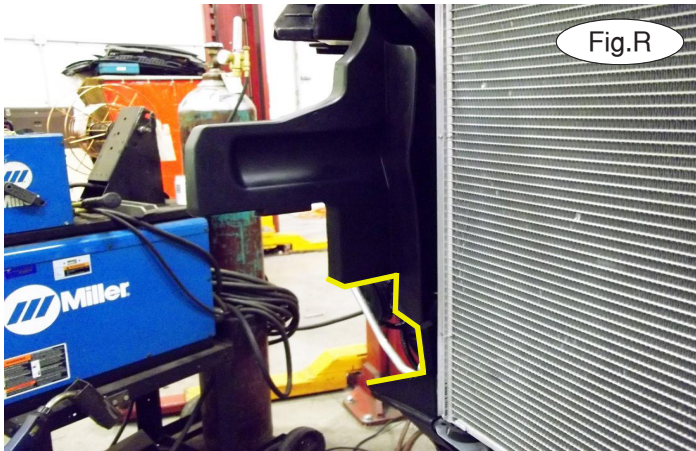

13. Trim the passenger side air dam as shown in Figure R and the driver's side air dam as shown in Figure S.

14. Place the main receiver brace over the ends of the frame rails and on each side, bolt into the bumper core mounting points using the four supplied 8mm x 1.25 x 30mm bolts, 8mm lock washers and 5/16" flat washers (Fig.T). Make certain that the cooling line does not contact the main receiver brace on the passenger side. If it does, bend it down and slightly out of the way (Fig.U). *Note:* ensure proper alignment, as the bolts will receive Loctite® Red and will be torqued at the end of these instructions.

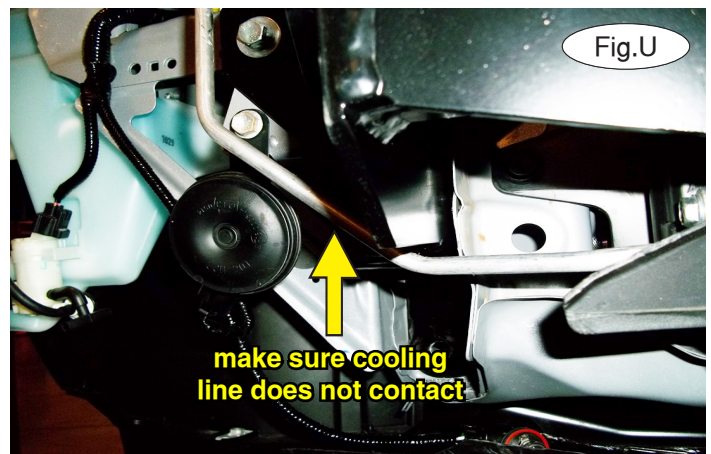
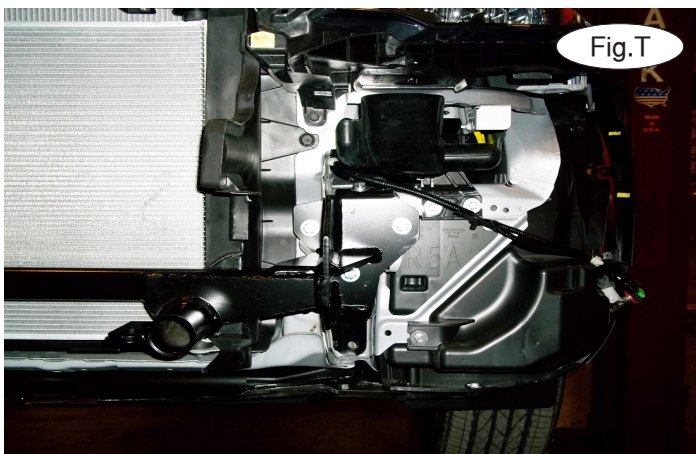

15. On the driver's side only, remove four plastic fasteners attaching the fender liner to the frame (Fig.V).





MOUNTING BRACKET KIT INSTALLATION INSTRUCTIONS

KIT# 521567-1

12/08/14
KS

ROADMASTER, Inc. 6110 NE 127th Ave. Vancouver, WA 98682 360-896-0407 fax 360-735-9300 www.roadmasterinc.com

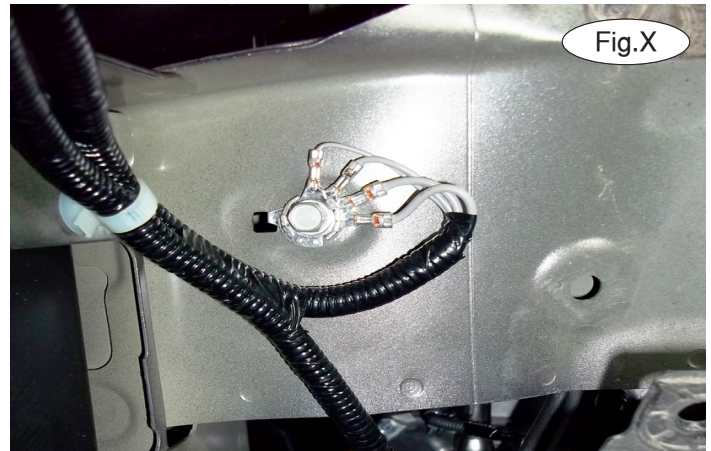
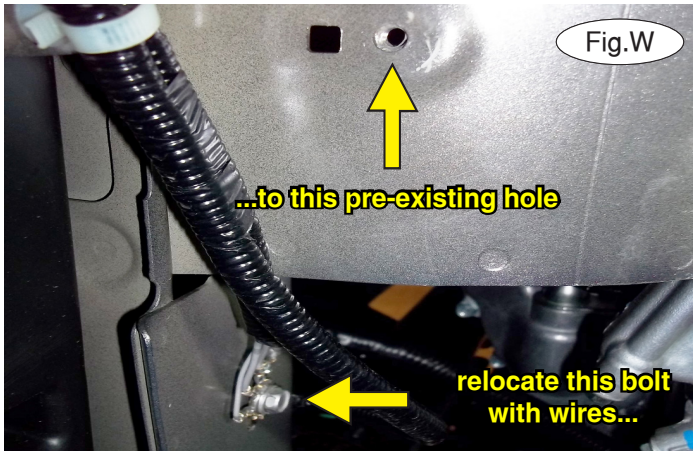

16. Now, pull back the fender liner and remove the 10mm (head) bolt with wires (Fig.W). Relocate it to the pre-existing threaded hole about six inches up on the side of the frame (Fig.X).

17. Working on the driver's side only, remove the 17mm (head) subframe bolt located directly beneath the driver's side lower mounting point of the receiver on the under side of the vehicle. **Warning: if you remove both subframe bolts at the same time, the subframe may detach from the vehicle. One subframe bolt must be installed on the vehicle and torqued to the manufacturer's specifications at all times.**

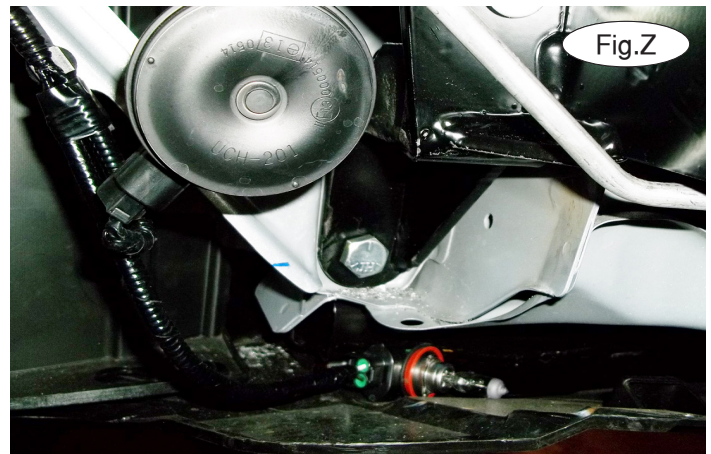
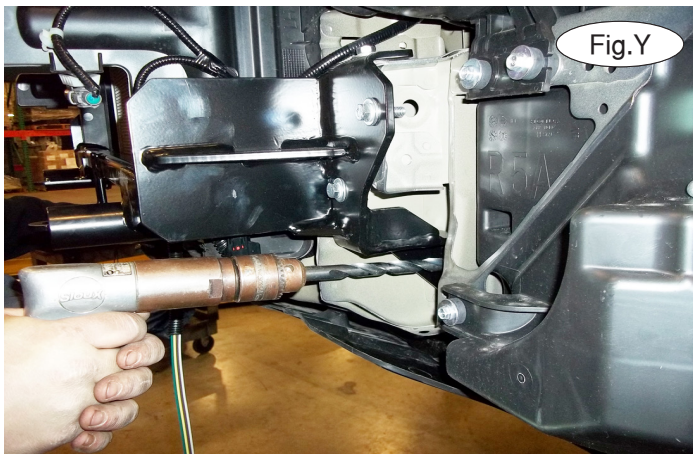

18. Working on the driver's side only, using the lower mounting point of the main receiver brace as a template, drill a 1/2" hole through the two layers of the frame rail (Fig.Y). *Note:* use caution to avoid drilling into the cooling line.

Now, bolt through the lower mounting point using the supplied 1/2" x 4 1/2" bolt, and finish with a 1/2" plate washer, lock washer and nut (Fig.Z).

19. Reinstall the 17mm (head) bolt you removed in step 17, ensuring that the bolt does not contact the 1/2" x 4 1/2" bolt installed in step 18. If it contacts it at all, cut off the tip of the subframe bolt using a cut-off wheel. Tighten all bolts to the bolt torque requirements found at the end of these instructions. *Note:* use Loctite® Red on all nuts and bolts.

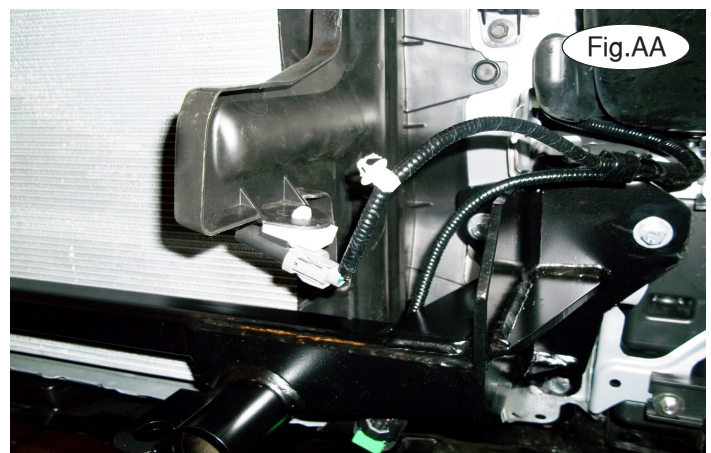

20. Now, repeat steps 17 through 19 for the passenger side of the vehicle.

21. Attach the ambient temperature sensor to the driver's side air dam as shown in Figure AA.

22. Reinstall the fascia, reversing steps 1 through 9.



MOUNTING BRACKET KIT INSTALLATION INSTRUCTIONS

KIT# 521567-1

12/08/14
KS

ROADMASTER, Inc. 6110 NE 127th Ave. Vancouver, WA 98682 360-896-0407 fax 360-735-9300 www.roadmasterinc.com

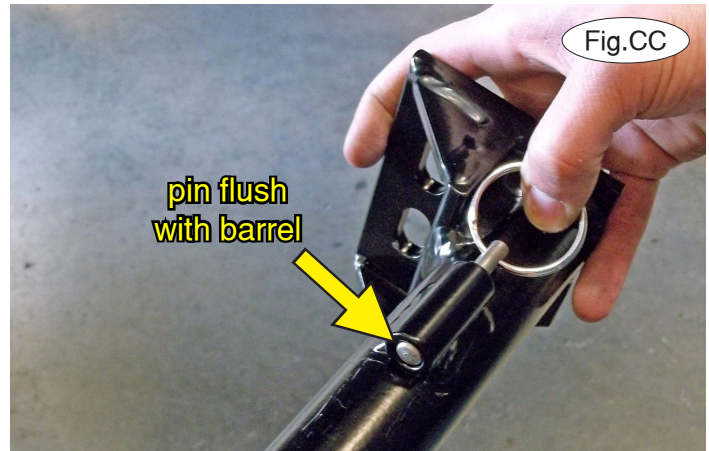

23. **Note: the following four images are for illustration purposes only, as your specific application may be slightly different.**

The spring-loaded pin on the removable arm snaps into a notch on the receiver, locking the removable arm into its final towing position. Before inserting each arm into the receiver, verify that the spring is working by ensuring that the spring-loaded pin moves easily back and forth within the barrel when pulled and that it can be pulled flush with the face of the barrel (Fig.BB and Fig.CC).

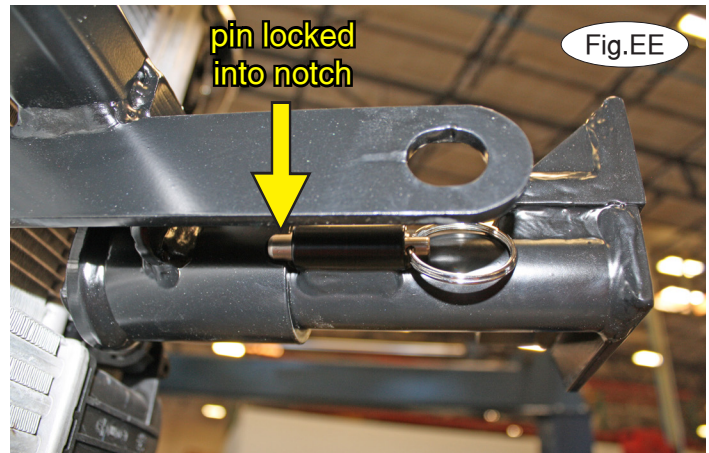

24. On each side, insert the removable front bracket arm into the front receiver 90 degrees from its final towing position, depressing the spring-loaded pin against the receiver (Fig.DD). Now, twist back 90 degrees until the spring-loaded pin snaps into place in the notch on the receiver, locking the arm into place in its final towing position (Fig.EE).

Please note: it is the owner's responsibility to ensure the locking of the pins before towing. Otherwise, failure of the towing system will result.

25. Install the tow bar to the mounting bracket according to the manufacturer's instructions.



MOUNTING BRACKET KIT INSTALLATION INSTRUCTIONS

KIT# 521567-1

12/08/14
KS

ROADMASTER, Inc. 6110 NE 127th Ave. Vancouver, WA 98682 360-896-0407 fax 360-735-9300 www.roadmasterinc.com

IMPORTANT!

Safety cables are required by law. When towing, connect safety cables to the safety cable tabs illustrated in Figure EE. Make certain there is adequate slack in the cables to allow a full turning radius; otherwise, damage will result. If necessary, longer cables or cable extensions are available.

Note: if the bracket is so equipped, the holes in the alignment tabs which are welded to the arms and main receivers are for padlocks only. Under no circumstances should you bolt the alignment tabs together. Bolting the alignment tabs together may result in non-warranty damage to the bracket.

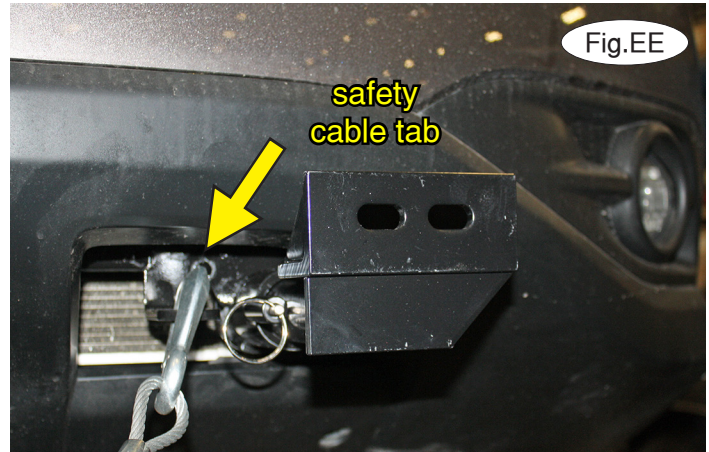

Fig.EE

Three options for attaching the wiring plug to the main receiver brace

For six-wire plugs: use the two supplied 3/4" self-tapping screws to attach the electrical plug directly to the rods on the front of the main receiver brace.

For four-wire round plugs: attach to the plug mounting plate and then use the two supplied 3/4" self-tapping screws to attach the mounting plate to the rods on the front of the main receiver brace.

For four-wire flat plugs: place the plug through the mounting plug plate, and then secure it using the supplied zip tie on the front of the plug (Fig.FF). Use the two supplied 3/4" self-tapping screws to attach the mounting plate to the rods on the front of the main receiver brace.

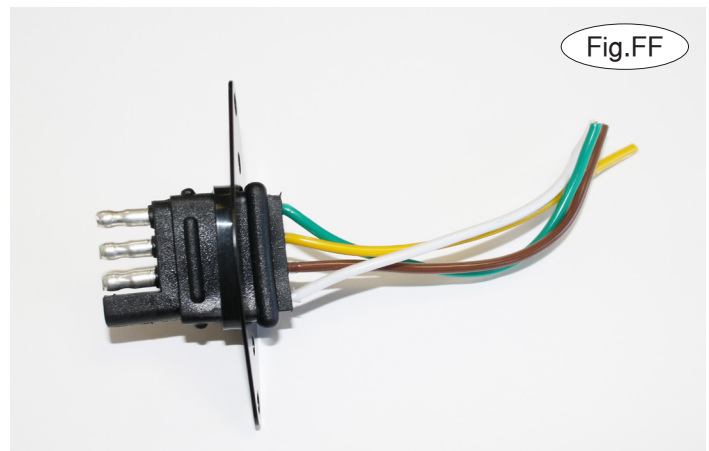

Fig.FF

BOLT TORQUE REQUIREMENTS

Note: The torque values represented below are intended as general guidelines. Torque requirements for specific applications may vary. Roadmaster does not warrant this information to be accurate for all applications and disclaims all liability for any claims or damages which may result from its use.

STANDARD BOLTS

Thread Size	Grade	Torque
5/16.....	5.....	13 ft./lb.
3/8.....	5.....	23 ft./lb.
7/16.....	5.....	37 ft./lb.
1/2.....	5.....	56 ft./lb.
5/8.....	5.....	150 ft./lb.

METRIC BOLTS

Thread Size	Grade	Plated / Unplated
8mm-1.0.....	8.8.....	20 ft./lb. 18 ft./lb.
8mm-1.25.....	8.8.....	19 ft./lb. 18 ft./lb.
10mm-1.25.....	8.8.....	38 ft./lb. 36 ft./lb.
10mm-1.5.....	8.8.....	37 ft./lb. 35 ft./lb.

METRIC BOLTS

Thread Size	Grade	Plated / Unplated
12mm-1.25.....	8.8.....	70 ft./lb. 65 ft./lb.
12mm-1.5.....	8.8.....	66 ft./lb. 61 ft./lb.
12mm-1.75.....	8.8.....	65 ft./lb. 60 ft./lb.
14mm-2.0.....	8.8.....	104 ft./lb. 97 ft./lb.

All illustrations and specifications contained herein are based on the latest information available at the time of publication approval. ROADMASTER, INC. reserves the right to make changes at any time without notice in material, specification and models or to discontinue models.