



# MOUNTING BRACKET KIT **KIT# 523163-1A**

## INSTALLATION INSTRUCTIONS

09/23/14  
KS

ROADMASTER, Inc. 6110 NE 127th Ave. Vancouver, WA 98682 360-896-0407 fax 360-735-9300 www.roadmasterinc.com

ROADMASTER, INC.

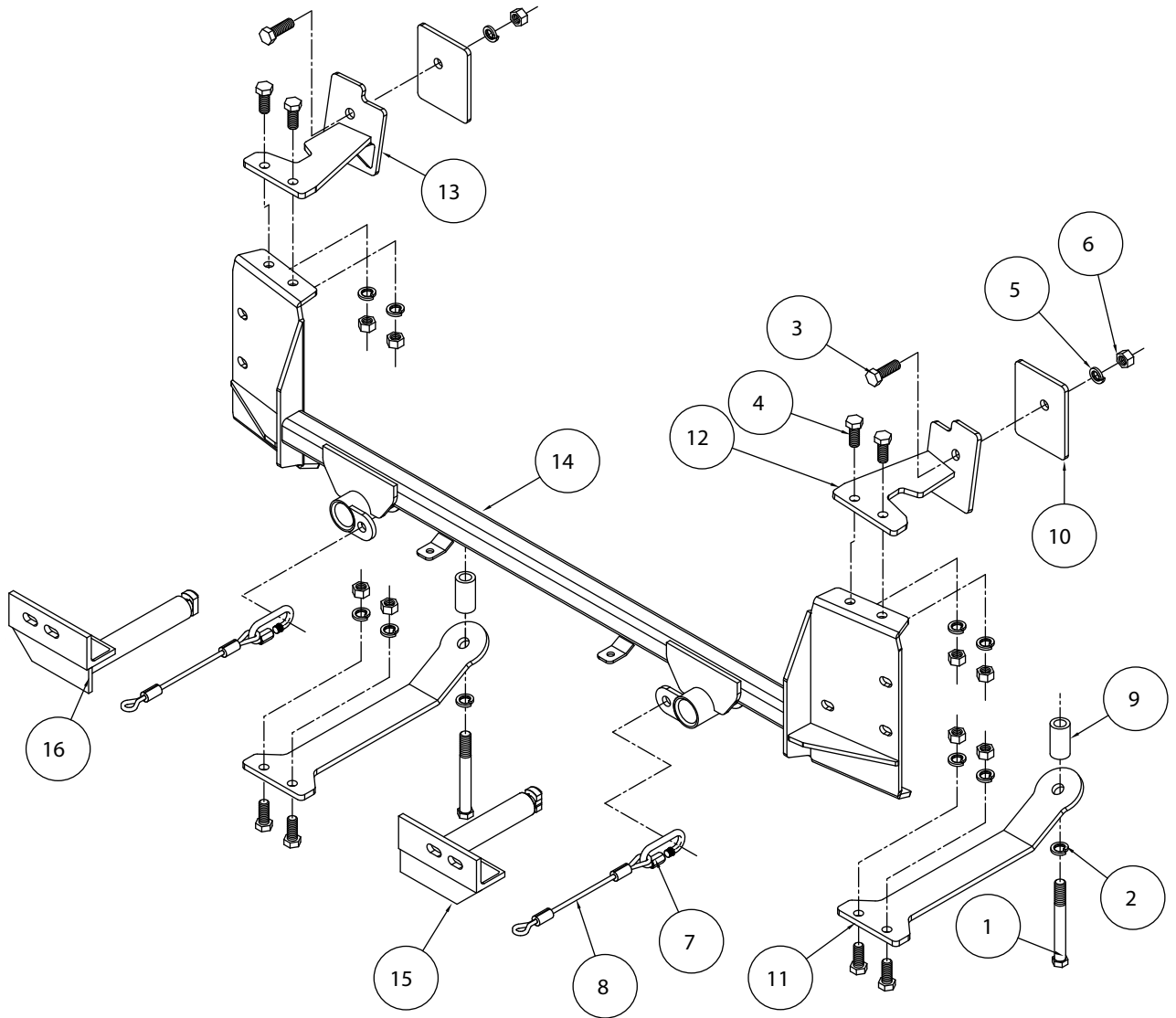

ITEM	QTY	NAME	MATERIAL
1	2	14mm x 2.0 x 160 mm BOLT	355910-18
2	2	14mm LOCK WASHER	355740-00
3	2	1/2" x 1 1/2" BOLT	350095-00
4	8	1/2" x 1 1/4" BOLT	350094-00
5	10	1/2" LOCK WASHER	350309-00
6	10	1/2" HEX NUT	350258-00
7	2	QUICK LINK	200008-00
8	2	SAFETY CABLE 8"	650646-08
9	2	1 x 1 7/8 SPACER	A-004511
10	2	1/4" x 3 1/2" x 4 1/2" BACKING PLATE	A-002964
11	2	LOWER BRACE	B-002454
12	1	DRIVER SIDE BRACE	C-001879
13	1	PASSENGER SIDE BRACE	C-001880
14	1	MAIN RECEIVER	C-001933
15	1	DRIVER SIDE ARM	C-001934
16	1	PASSENGER SIDE ARM	C-001935
17	4	ZIP TIE	300140-10



# MOUNTING BRACKET KIT INSTALLATION INSTRUCTIONS

**KIT# 523163-1A**

09/23/14  
KS

ROADMASTER, Inc. 6110 NE 127th Ave. Vancouver, WA 98682 360-896-0407 fax 360-735-9300 www.roadmasterinc.com

This is one of our EZ series brackets, which allows the visible front portion of the bracket to be easily removed from the front of the vehicle (Fig.A and Fig.B). The bracket consists of a main receiver brace, two rear support braces, two upper support braces, two removable front braces and a hardware pack.

The main receiver brace mounts to the bumper core and frame rails. The rear support braces are attached to the main receiver brace and frame rails. The upper support braces are attached to the main receiver brace and the frame. The removable front braces install in the main receiver brace.

Before starting the installation, lay out the kit components in order, as they will be used. This will give you a visual idea of how the components work, and will also confirm that everything is present and accounted for.



**IMPORTANT:** All brackets **must** be assembled with all the bolts left loose for final adjustment and positioning (before tightening) unless otherwise instructed. All bolts **must** be torqued for proper strength. If more than one bolt is used per fastening point, the diagram may only show one.

- Use flat washers over all slotted holes
- Use lock washers on all fasteners

ROADMASTER Limited Warranty, including One-Year Conditional Warranty Text and Product Registration Card, in Carton.

## WARNING

Failure to follow these instructions can result in property damage, personal injury or even death.

- Installation of most mounting brackets requires moderate mechanical aptitude and skills. We strongly recommend professional installation by an experienced installer.
- The installer must read the instructions and use all bolts and parts supplied. Failure to do so could result in loss of the towed vehicle.
- Use Loctite® Red on all bolts used for mounting this bracket.
- Every 3,000 miles, the owner must inspect the fasteners for proper torque, according to the bolt torque requirements chart on the last page of these instructions. The owner must also inspect all mounts and brackets for cracks or other signs of fatigue every 3,000 miles. Failure to do so could result in loss of the towed vehicle.
- The owner must check the vehicle manufacturer's instructions for the proper procedure(s) to prepare the vehicle for towing. Some vehicles must be equipped with a transmission lube pump, an axle disconnect, driveline disconnect or free-wheeling hubs before they can be towed. Failure to properly equip the vehicle will cause severe damage to the transmission.
- If running changes were made by the vehicle manufacturer after this bracket was designed, some bolts or other fasteners in the hardware pack may no longer be the correct size. It is the installer's responsibility to verify that the bracket is securely fastened to the vehicle and fitted with the correct hardware to account for these changes. Failure to securely fasten the bracket could result in loss of the towed vehicle.
- If the towed vehicle has been in an accident, it must be properly repaired before attaching the bracket. Do not install the bracket if any structural frame damage is found. Failure to repair the damage could result in the loss of the towed vehicle.
- Roadmaster manufactures many styles of brackets. If your bracket has removable arms, they must be removed before driving the vehicle, unless the arms can be pinned or padlocked in place. If not secured, the arms could vibrate out, resulting in non-warranty damage or personal injury.
- Some motorhome chassis have such a tight turning radius that you can damage your motorhome, towed vehicle, tow bar or bracket while turning sharply. Before getting on the road, test your turning radius in an empty parking lot. Turning too sharply could result in non-warranty damage to towing system, motorhome and/or towed vehicle.
- Do not back up with the towed vehicle attached or non-warranty damage will occur to your towing system, motorhome and/or towed vehicle.
- The safety cables must connect the towing vehicle to the towed vehicle frame to frame, with the cables crossed, with enough slack for sharp turns. Refer to the cable instructions for proper routing. Failure to leave enough slack in the safety cables, or failure to connect the safety cables frame to frame, will result in the loss of the towed vehicle.
- This bracket is designed for use with ROADMASTER tow bars and ROADMASTER adaptors only. Using this bracket with other brands, without an approved ROADMASTER adaptor, may result in non-warranty damage or injury.
- Do not use this document for custom fabrication, as it may not show all parts or structural components. Custom fabrication or an attempt to copy this bracket design could result in loss of the towed vehicle.
- Upon final installation, the installer must inspect the bracket to ensure adequate clearance, particularly around hoses, air conditioner lines, radiators, etc., or non-warranty damage to the towed vehicle will result.
- This bracket is only warranted for the original installation. Installing a used bracket on another vehicle is not recommended and will void the warranty.



# MOUNTING BRACKET KIT INSTALLATION INSTRUCTIONS

**KIT# 523163-1A**

09/23/14  
KS

ROADMASTER, Inc. 6110 NE 127th Ave. Vancouver, WA 98682 360-896-0407 fax 360-735-9300 www.roadmasterinc.com

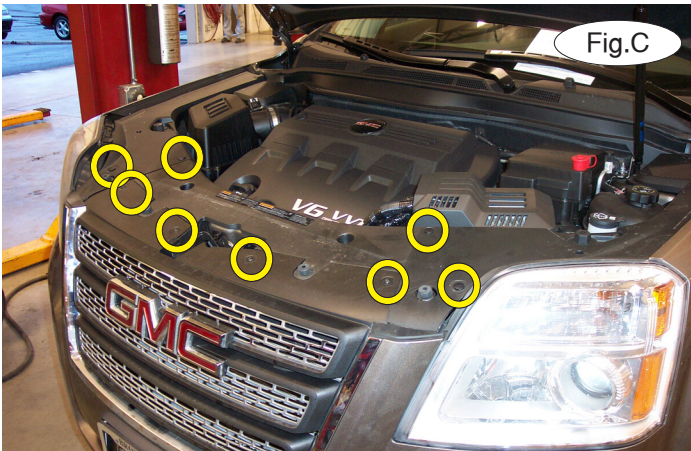

1. **Important:** please use all supplied bolts and parts and read all instructions carefully before beginning this installation. The majority of questions you may have can be answered within the text, and proper installation will ensure safe and secure travel. Now, begin the installation by removing four plastic fasteners and four T20 Torx bolts attaching the top of the fascia to the core support (Fig.C).

2. On each side, remove one T20 Torx bolt and three plastic fasteners attaching the edge of the fender liner to the fascia (Fig.D).



3. On each side, remove two 7mm (head) bolts attaching the bottom of the fascia to the fender liners (Fig.E).

4. Disconnect the fog lights, if the vehicle is so equipped. Pull forward to remove the fascia (Fig.F).

5. Remove two 10mm screws attaching the power steering cooler to the bumper core (Fig.G).

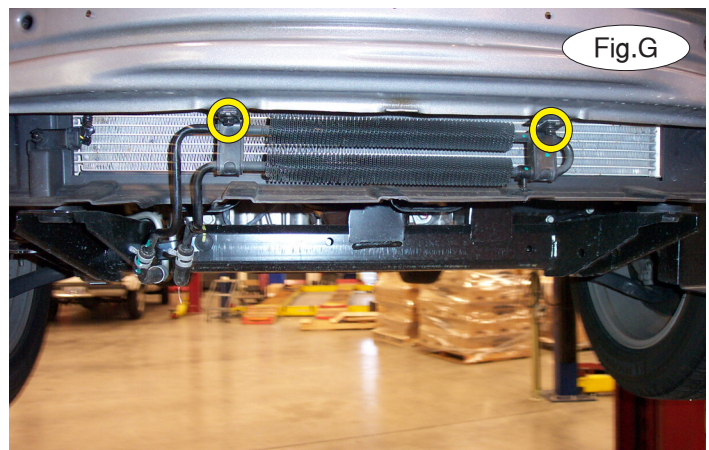



# MOUNTING BRACKET KIT INSTALLATION INSTRUCTIONS

**KIT# 523163-1A**

09/23/14  
KS

ROADMASTER, Inc. 6110 NE 127th Ave. Vancouver, WA 98682 360-896-0407 fax 360-735-9300 www.roadmasterinc.com

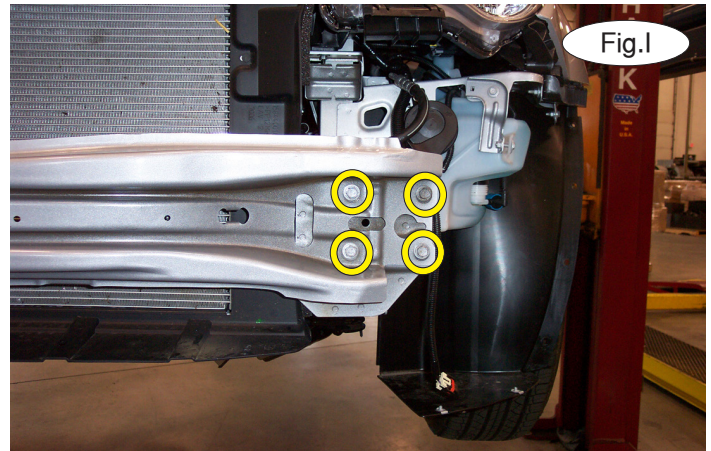
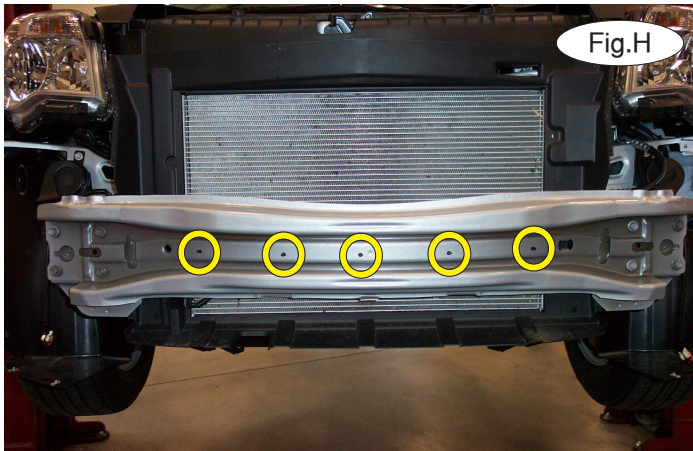

6. Unsnap five plastic clips to remove the wiring harness from the back of the bumper core (Fig.H).

7. On each side, remove four 13mm (head) bolts attaching the bumper core to the frame rails (Fig.I). The bumper core will not be replaced. Retain the bumper core in case the bracket is ever removed. *Note:* due to manufacturing variances, the upper inside hole may not be present.

Now, unsnap one plastic clip on each side attaching the wiring harness to the end of the frame rail and one plastic fastener attaching the ambient temperature sensor to the core support.

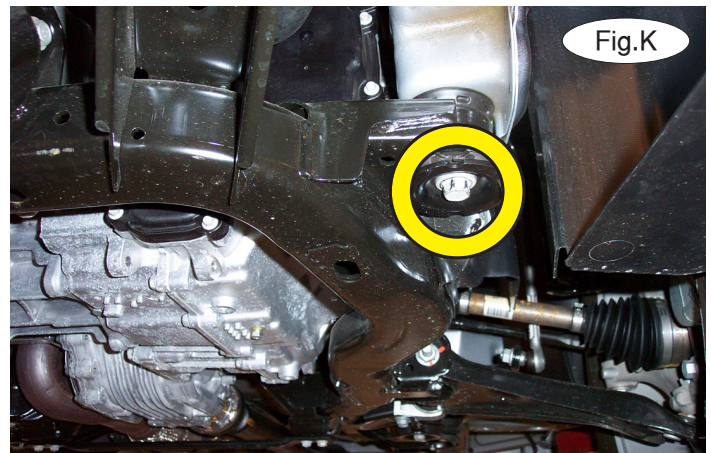

8. Place thread lock on six of the eight bolts you removed in the previous step and use them to attach the main receiver brace to the ends of the frame rails (Fig.J). *Note:* due to manufacturing variances, one of the mounting holes may be where the yellow arrow is instead. Tighten the bolts to the bolt torque requirements found at the end of these instructions.

9. Working on the driver's side, remove the 18mm subframe bolt. *Note:* do not remove both subframe bolts without supporting the frame (Fig.K).

10. Using one of the supplied 14mm x 2.0 x 160mm bolts, bolt through the lower rear brace and a 1" x 1 7/8" pipe spacer and into the subframe (Fig.L). *Note:* use Loctite® Red on all bolts used for mounting this bracket.

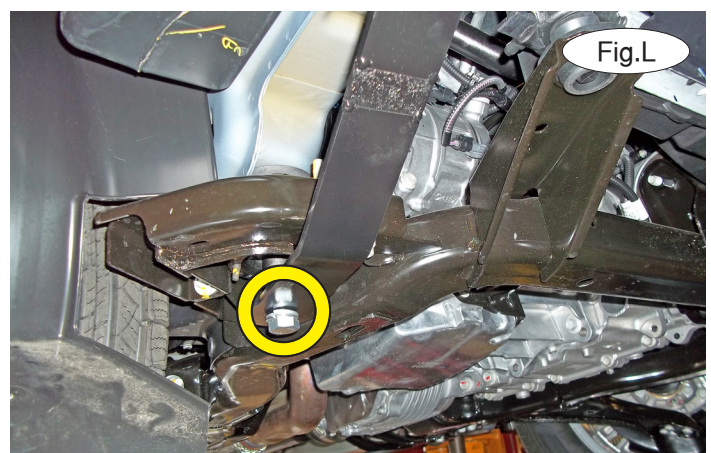



# MOUNTING BRACKET KIT INSTALLATION INSTRUCTIONS

**KIT# 523163-1A**

09/23/14  
KS

ROADMASTER, Inc. 6110 NE 127th Ave. Vancouver, WA 98682 360-896-0407 fax 360-735-9300 www.roadmasterinc.com

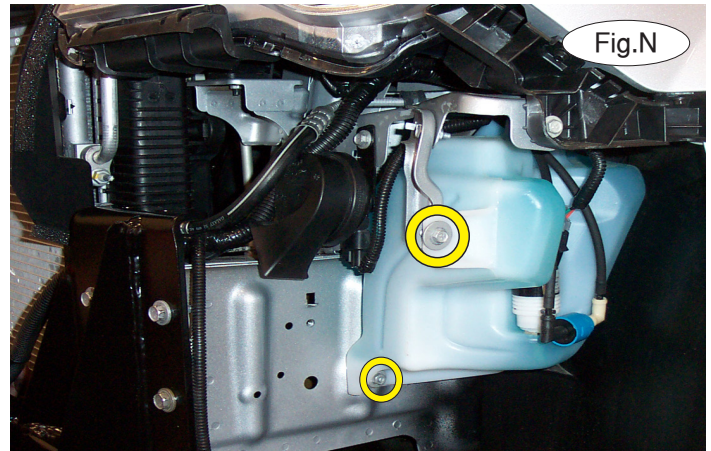
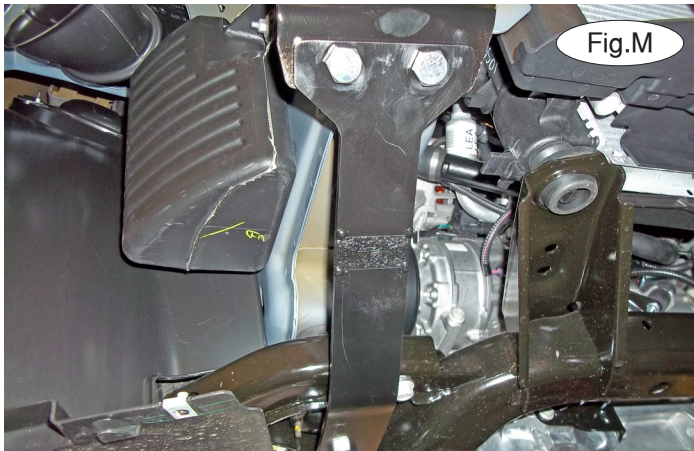

11. Using two of the supplied  $\frac{1}{2}$ " x  $1\frac{1}{4}$ " bolts, lock washers and nuts, bolt the lower brace to the main receiver brace (Fig.M). Tighten the bolts to the bolt torque requirements found at the end of this document.
12. Repeat steps 9 through 11 for the passenger side of the vehicle.

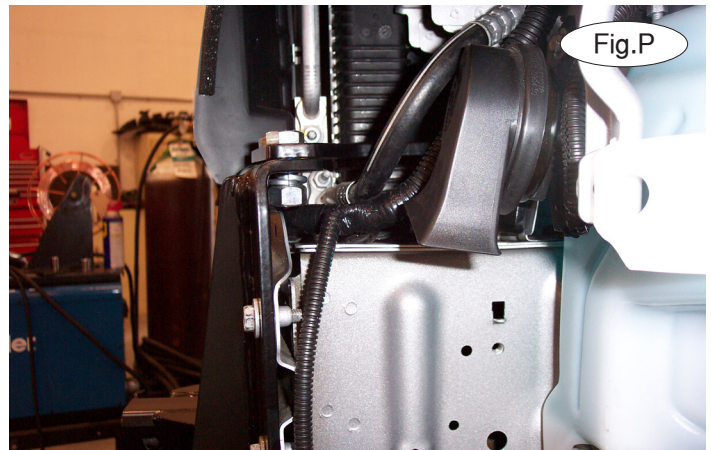
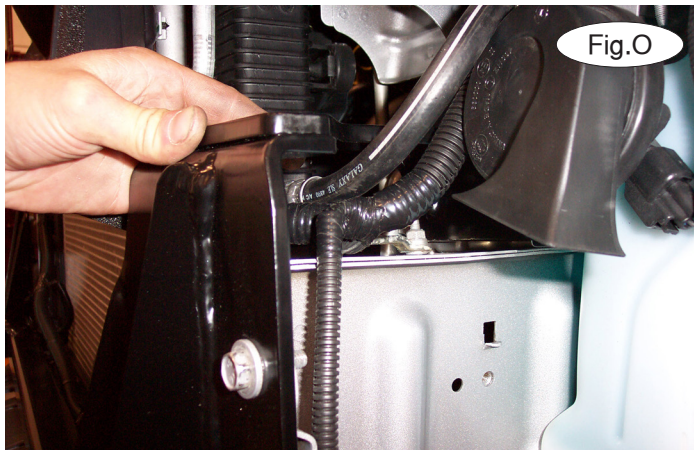

13. Working on the driver's side, loosen the 10mm bolt and 10mm nut attaching the washer bottle to the frame rail (Fig.N).
14. Position the upper rear brace over the top of the main receiver brace (Fig.O).
15. Using two of the supplied  $\frac{1}{2}$ " x  $1\frac{1}{4}$ " bolts, lock washers and nuts, bolt the upper rear brace to the main receiver brace (Fig.P).
16. Place one of the  $3\frac{1}{2}$ " x  $4\frac{1}{2}$ " backing plates through the opening in the side of the frame behind the upper rear brace (Fig.Q).

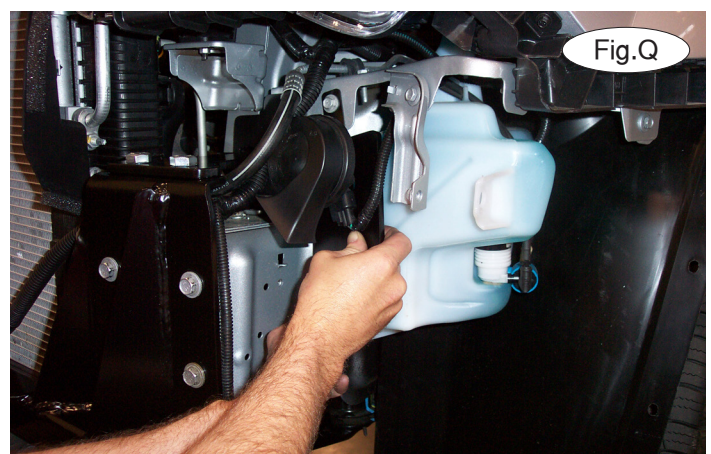



# MOUNTING BRACKET KIT INSTALLATION INSTRUCTIONS

**KIT# 523163-1A**

09/23/14  
KS

ROADMASTER, Inc. 6110 NE 127th Ave. Vancouver, WA 98682 360-896-0407 fax 360-735-9300 www.roadmasterinc.com

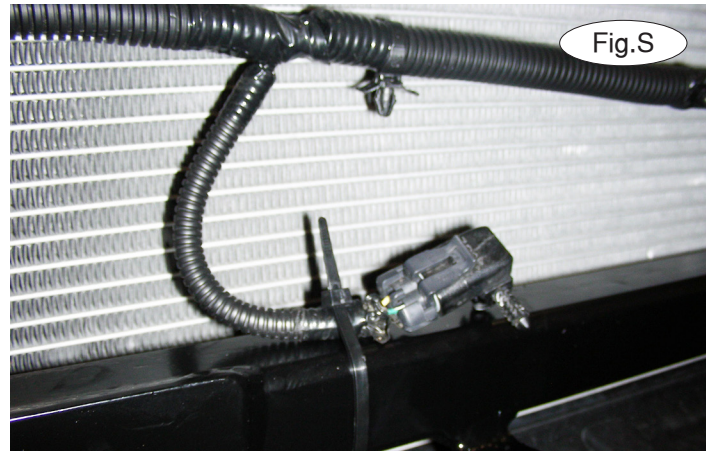

17. Bolt the upper brace into place using one of the supplied  $\frac{1}{2}$ " x  $1\frac{1}{2}$ " bolts, lock washers and nuts (Fig.R).
18. Repeat steps 13 through 17 for the passenger side of the vehicle. Torque the bolts to the bolt torque requirements found at the end of this document.
19. Using two of the supplied zip ties, remount the ambient temperature sensor to the cross member of the main receiver brace (Fig.S).

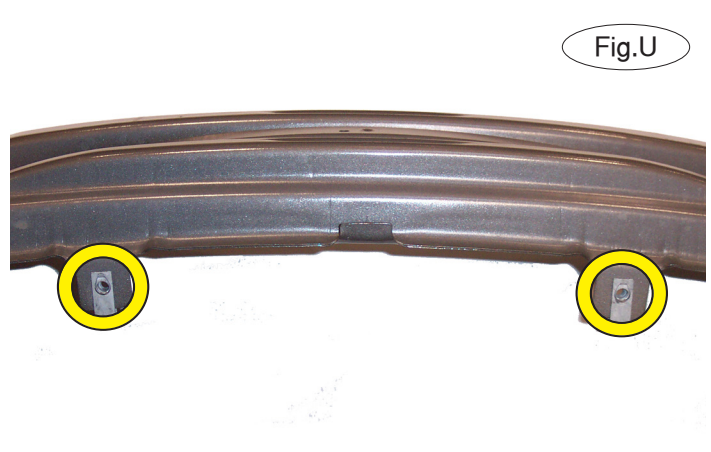
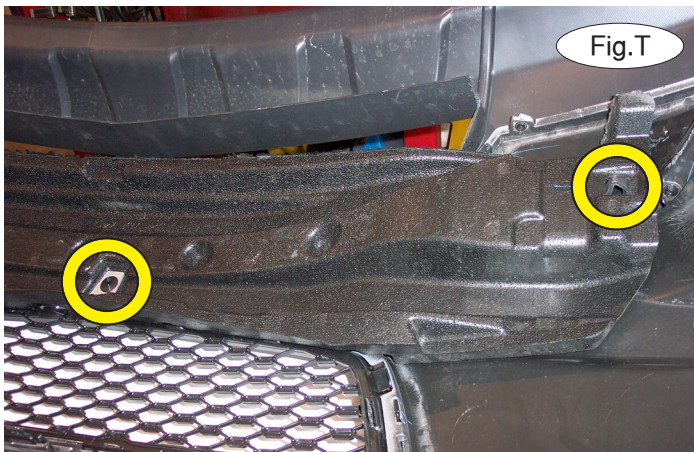

20. Remove the foam shock absorption pad from the back of the fascia by removing two plastic clips and one screw. Figure T only shows one clip and the screw. *Note:* due to manufacturing variances, some vehicles may have four clips.
21. Remove the two slip nuts located on the bottom of the bumper core (Fig.U).
22. Place the two slip nuts on the mounting points of the main receiver brace and bolt the power steering cooler to the main receiver brace using the screws you removed in step 5.

Now, using four of the supplied zip ties, attach the wiring harness to the main receiver brace (Fig.V).

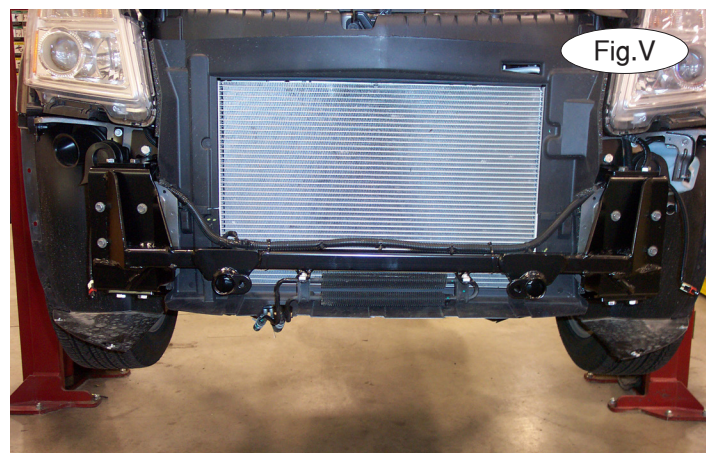



# MOUNTING BRACKET KIT INSTALLATION INSTRUCTIONS

**KIT# 523163-1A**

09/23/14  
KS

ROADMASTER, Inc. 6110 NE 127th Ave. Vancouver, WA 98682 360-896-0407 fax 360-735-9300 www.roadmasterinc.com

- 23. Reassemble the fascia by reversing steps 1 through 4.
- 24. Insert the removable front braces into the main receiver brace and twist 90 degrees to lock them in place. *Note:* due to manufacturing variances, it is expected that the passenger side rear cam will contact the ambient temperature sensor slightly. Relocate the ambient temperature sensor so that it doesn't contact the cam.
- 25. Attach the 8" safety cables with the cable connectors (Q-Links) to the front of the receiver braces (Fig.W).
- 26. Attach the ends of the safety cables to the tow vehicle's safety cables.
- 27. Install the tow bar to the mounting bracket according to the manufacturer's instructions.



*Note:* if the bracket is so equipped, the holes in the alignment tabs which are welded to the arms and main receiver braces are for padlocks only. Under no circumstances should you bolt the alignment tabs together. Bolting the alignment tabs together may result in non-warranty damage to the bracket.

## BOLT TORQUE REQUIREMENTS

Note: The torque values represented below are intended as general guidelines. Torque requirements for specific applications may vary. Roadmaster does not warrant this information to be accurate for all applications and disclaims all liability for any claims or damages which may result from its use.

### STANDARD BOLTS

Thread Size	Grade	Torque
5/16.....	5.....	13 ft./lb.
3/8.....	5.....	23 ft./lb.
7/16.....	5.....	37 ft./lb.
1/2.....	5.....	56 ft./lb.
5/8.....	5.....	150 ft./lb.

### METRIC BOLTS

Thread Size	Grade	Plated / Unplated
8mm-1.0.....	8.8.....	20 ft./lb. 18 ft./lb.
8mm-1.25.....	8.8.....	19 ft./lb. 18 ft./lb.
10mm-1.25.....	8.8.....	38 ft./lb. 36 ft./lb.
10mm-1.5.....	8.8.....	37 ft./lb. 35 ft./lb.

### METRIC BOLTS

Thread Size	Grade	Plated / Unplated
12mm-1.25.....	8.8.....	70 ft./lb. 65 ft./lb.
12mm-1.5.....	8.8.....	66 ft./lb. 61 ft./lb.
12mm-1.75.....	8.8.....	65 ft./lb. 60 ft./lb.
14mm-2.0.....	8.8.....	104 ft./lb. 97 ft./lb.

All illustrations and specifications contained herein are based on the latest information available at the time of publication approval. ROADMASTER, INC. reserves the right to make changes at any time without notice in material, specification and models or to discontinue models.