



# BX2338

## 2012-17 Hyundai Accent GLS/SE (Includes Foglights) Installation Instructions

**Attachment Tab Height: 14"**

**Attachment Tab Width: 24"**

**Serial Number**

**Please read BOTH these Installation Instructions and the General Instructions prior to installing or operating this equipment.**

- Blue Ox® towing products and accessories are intended to be installed by Blue Ox® Dealers who are familiar with our products and have the equipment and knowledge necessary to do "fit work". If needed, Blue Ox® Dealers can be found at [www.blueox.com](http://www.blueox.com) or by contacting our Customer Care Department at (402) 385-3051.
- Many Blue Ox® baseplates are designed to use existing holes and hardware to mount the baseplate to the towed vehicle. Even though bolts are there, do not assume they are adequate for baseplate mounting. Always use the hardware supplied in the hardware kit and existing hardware as specified in the installation instructions.

### Bolt Torque Specifications

Torque in Foot-Pounds for Inch Bolts

Bolt Size	Grade 5	Grade 8
1/4"	10	14
5/16"	19	29
3/8"	33	47
7/16"	54	78
1/2"	78	119
5/8"	154	230
3/4"	257	380

### Bolt Torque Specifications

Torque in Foot-Pounds for Metric Bolts

Bolt Size	Grade 8.8	Grade 10.9
6MM	6	8
8MM	16	22
10MM	31	40
12MM	54	70
14MM	89	117
16MM	161	230
18MM	222	318



If the front of your vehicle looks different than this, please contact us at (402)385-3051.

**Reference your vehicle owner's manual for manufacturer's towing specifications.**



## WARNING

Failure to read and follow these instructions could result in separation of the towed vehicle from the tow bar, causing property damage, loss of towed vehicle, personal injury or death.

BX2338  
2012-17 Hyundai Accent GLS/SE (Includes Foglights)  
Installation Instructions

**Instruction Notes:** The fascia, fascia cover, air baffle and windshield washer fluid reservoir are removed and reinstalled for the baseplate installation. Some drilling and trimming is required.

Place all components that are removed on a flat, sturdy surface. All items will be reinstalled unless otherwise noted after the baseplate is installed.

The dimensional variations between otherwise identical vehicles can be considerable. While the baseplate was designed for easy installation, it may be necessary to tailor the baseplate slightly to compensate for vehicle manufacturer's tolerances.

The BX8869 Tail Light Wiring Kit is recommended for this vehicle.



Drill a hole according to the tail  
light wiring kit instructions.

### **NOTICE**

- Handling of some cosmetic parts when installing this product may require the use of protective covers, rags, specialty tools, etc. to prevent damage.
- When using power drills be aware of the dangers of torque and drill bit length.
- When using a reciprocating saw be aware of objects behind the cutting surface.
- Use a good quality paint to spray cut edges of frame to prevent rusting.
- Be sure that **ALL** electrical connections are plugged in and accessories are functioning properly before reinstalling the fascia.
- The baseplate is computer tested to your vehicle's GVWR, exceeding this weight will void the manufacturer's warranty.
- Be sure to use a sufficient amount of Loctite® Red on all bolt threads before tightening. Tighten all bolts according to the torque chart provided.
- Dealer or installer be certain the user receives these instruction sheets.
- If the baseplate is in an accident, it must be replaced. **DO NOT** use it again! An accident can cause unseen damage and using it again could result in more damage or serious injury. **DO NOT** use the baseplate if it is damaged or missing parts.

**BX2338**  
**2012-17 Hyundai Accent GLS/SE (Includes Foglights)**  
**Installation Instructions**

**Tools Required**

Large Vise Grip  
 Reciprocating Saw  
 Utility Knife  
 Phillips Screwdriver  
 Torque Wrench  
 Drill  
 1-1/4" Hole Saw  
 Tape Measure  
 Loctite® RED  
 13/32" Drill Bit  
 10MM Socket  
 12MM Socket  
 9/16" Socket  
 9/16" Wrench

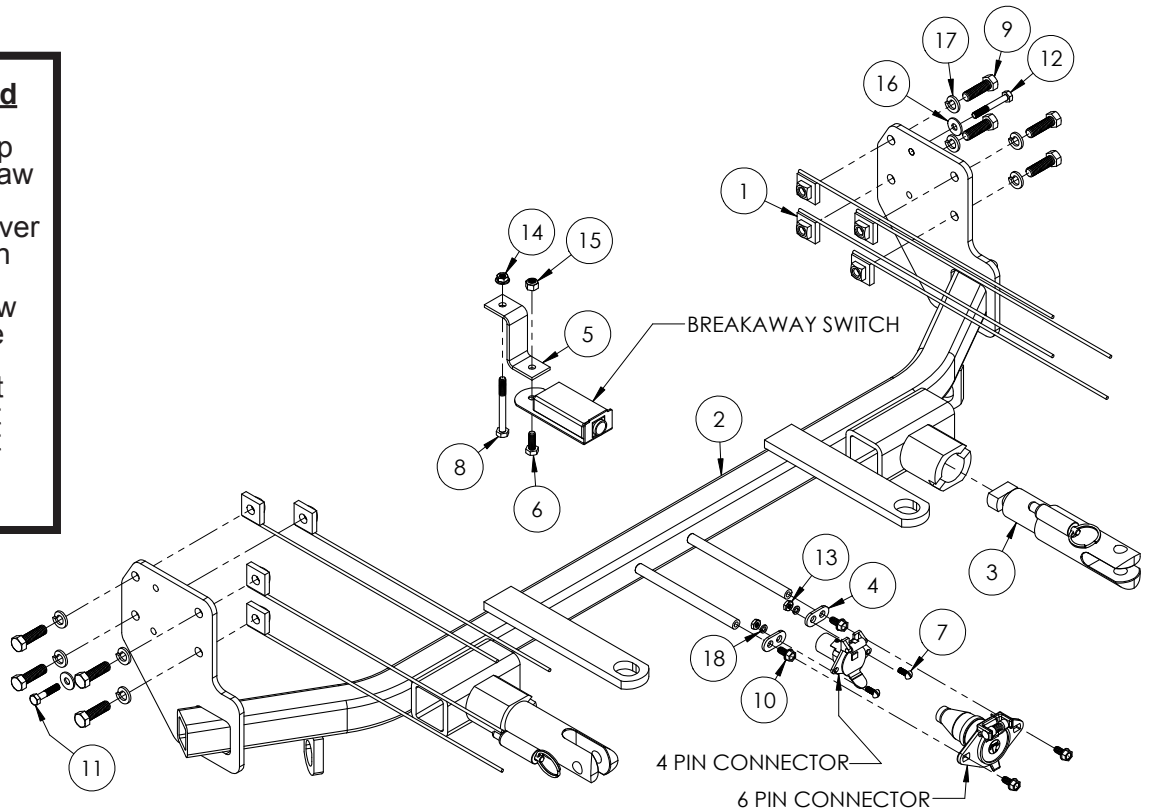

Item No.	Part No.	Description	Qty.
1.....	61-5208.....	3/8"-16 Nut Plate w/ 14" Wire.....	8
2.....	61-7271.....	BX2338 Baseplate.....	1
3.....	62-3468.....	Attachment Tab Assembly with Hole.....	2
4.....	101-5822.....	4 Way Connector Adapter.....	2
5.....	102-7056.....	Breakaway Bracket.....	1
6.....	201-0050.....	1/4"-20 x 3/4" Hex Head Bolt, Grade 5, ZP.....	1
7.....	201-0192.....	#10-32 1/2" Round Slotted Head Screw.....	2
8.....	201-0321.....	1/4"-20 x 2-1/2" Hex Head Bolt, Grade 5, ZP.....	1
9.....	201-0368.....	3/8"-16 x 1-1/4" Hex Head Bolt, Grade 5, ZP.....	8
10.....	201-0979.....	#12-14 x 1" Self Drilling Screw, ZP.....	2
11.....	201-0655.....	6MM-1.0 x 30MM Hex Head Bolt, Grade 8.8, ZP.....	1
12.....	201-0702.....	6MM-1.0 x 45MM Hex Head Bolt, Grade 8.8, ZP.....	1
13.....	202-0047.....	#10-32 Hex Nut.....	2
14.....	202-0069.....	1/4"-20 Hex Flange Whiz Lock Nut, ZP.....	1
15.....	202-0102.....	1/4"-20 Hex Nylon Nut, ZP.....	1
16.....	203-0001.....	1/4" Flat Washer, ZP.....	2
17.....	203-0010.....	3/8" Lock Washer, ZP.....	8
18.....	203-0054.....	#10 Lock Washer.....	2
19.....	226-0046(not shown).....	Class III Safety Cables.....	2
21.....	229-0359(not shown).....	3/8" Quicklink, ZP.....	2
22.....	290-0437(not shown).....	Receiver Cap Plug.....	2

**Important:**

Use only genuine factory replacement parts on your baseplate. Do **NOT** substitute homemade or non-typical parts. If a bolt is lost or in need of replacement, for your safety and the preservation of your baseplate, be sure to use a replacement bolt of the same grade (In most cases it will be Grade 5, please reference the parts list above). Replacement parts may be ordered through your nearest Blue Ox® Dealer or Distributor. Failing to follow and/or altering these installation instructions in either installation or required equipment will void the manufacturer's warranty. Towing behind a non-motorized vehicle will void the warranty.

BX2338  
2012-17 Hyundai Accent GLS/SE (Includes Foglights)  
Installation Instructions

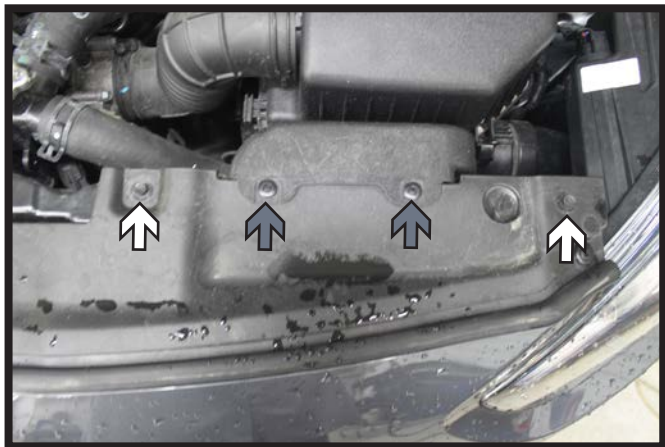

1. Using a 10MM socket, remove the four (4) screws (white) from the top of the fascia. There are two (2) on each side of the vehicle. Then remove the two (2) push pins on the driver side (gray).

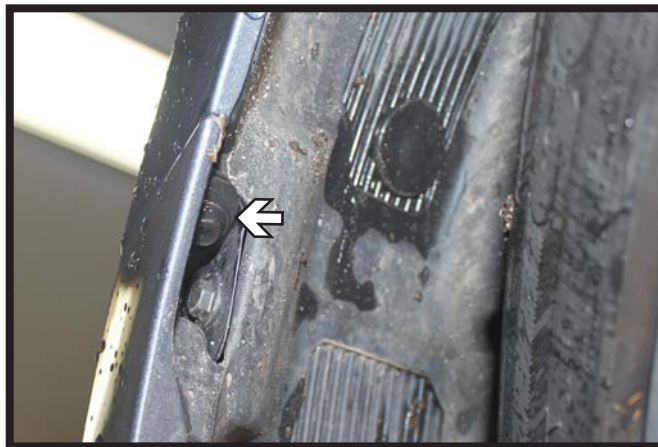

2. In wheel well, using a 10MM socket, remove upper screw from the fascia joint. Do this to both sides of the vehicle.

3. On the underside of the fascia, remove four (4) push pins from the corners. There are two (2) on each side.



4. Using a 10MM socket, remove the three (3) screws from the middle of the fascia. **2017 Model Year:** Will need to remove five (5) screws from the bottom of the fascia.



5. Lift up and pull out the corners of the fascia. Remove the fascia from the vehicle disconnecting any electrical connections and set fascia aside.



BX2338  
2012-17 Hyundai Accent GLS/SE (Includes Foglights)  
Installation Instructions

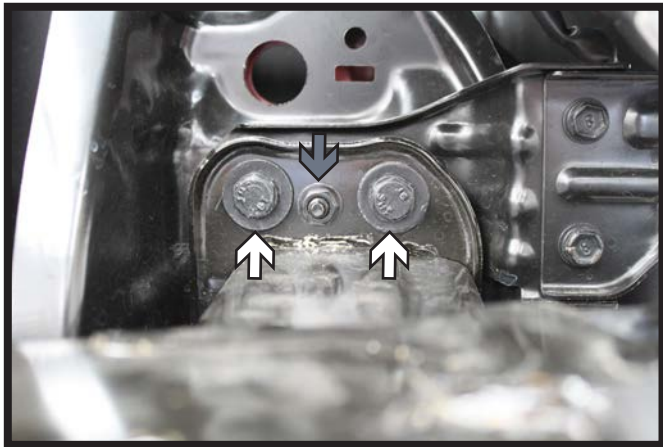

6. Using a 12MM socket, remove the two (2) bolts from top of metal bumper (white). With a 10MM socket, remove the bolt in the backside of the bumper (gray). Do this to both sides of the vehicle.

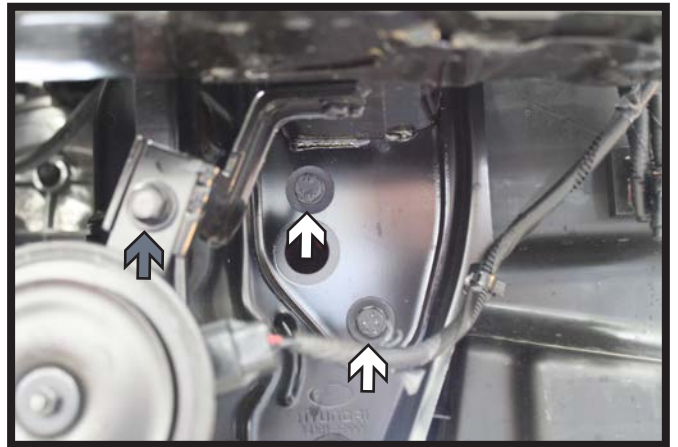

7. Using a 12MM socket, remove the two (2) bolts from bottom of bumper (white). Using a 10MM socket, remove the horn bracket bolt (gray). Do this to both sides of the vehicle. Set the bumper aside.



8. Using a Phillips screwdriver, remove the screw at the front of the reservoir (gray). Using a 10MM socket, remove the two (2) screws from the backside of the washer reservoir (white). Disconnect and plug all lines, then set washer reservoir aside.

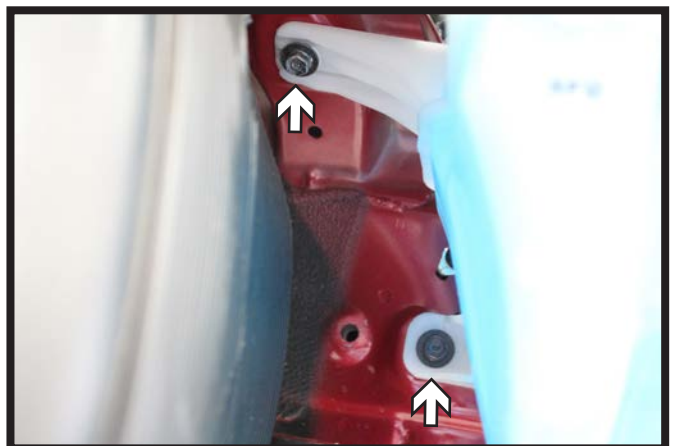

BX2338  
2012-17 Hyundai Accent GLS/SE (Includes Foglights)  
Installation Instructions

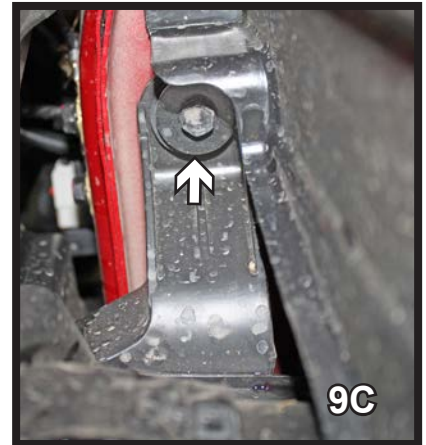
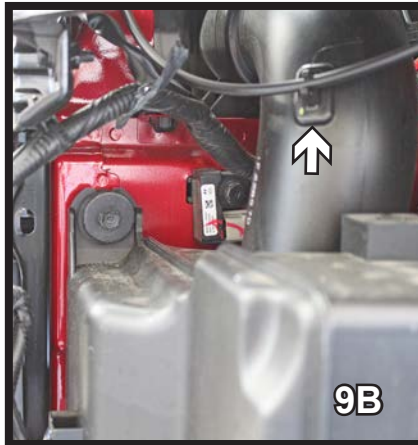
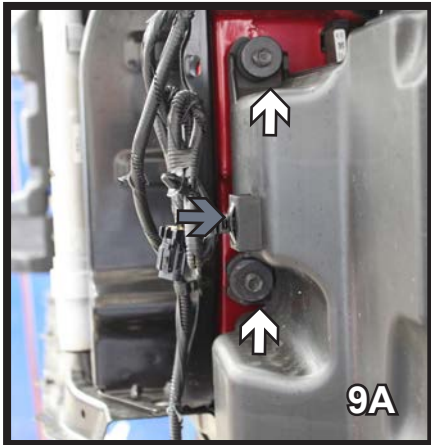

9. On the driver side, remove the push pin (9A - gray). Using a 10MM socket, remove the two (2) screws (9A-white) and the one (1) screw on the underside of the fascia (9C). Disconnect the hose from the air baffle (9B) and remove from the vehicle.

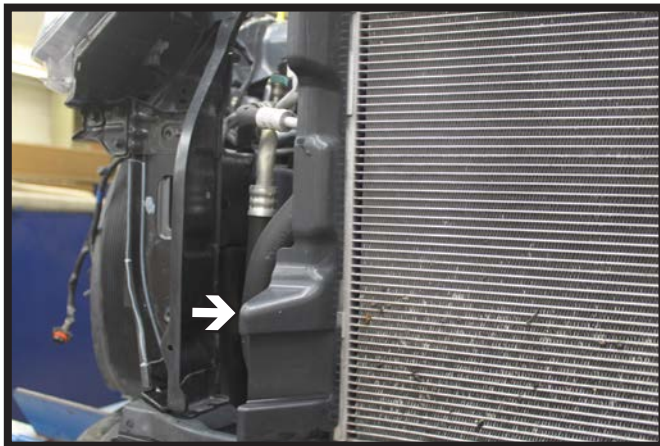

10. On the passenger side, remove the plastic shrouding next to the radiator for baseplate clearance.

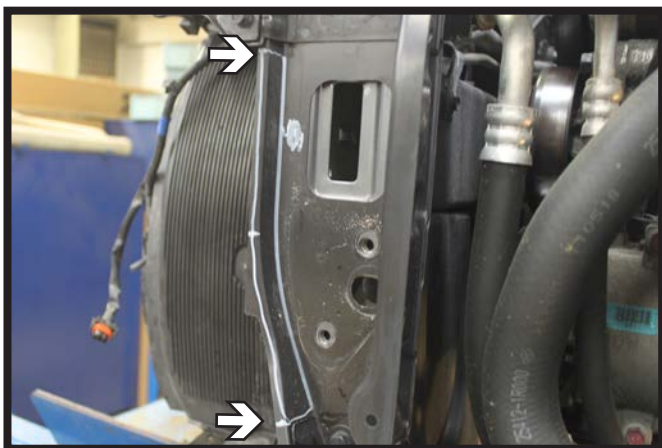

11. Using a reciprocating saw, trim the lip off the face of the frame as shown for baseplate clearance. Do this on both sides of the vehicle. Reinstall the bumper with the existing bolts.



BX2338  
2012-17 Hyundai Accent GLS/SE (Includes Foglights)  
Installation Instructions



12. Using a reciprocating saw, cut two (2) slits on the bottom hole in the frame and bend the tab out to allow nut plate access. Do this on both sides of the vehicle.

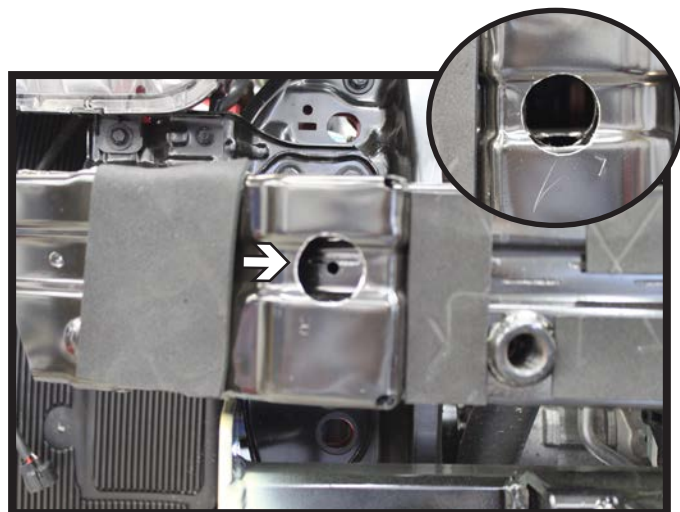

13. On the front of the bumper, toward the outer edge of the bumper, with a 1-1/4" hole saw, cut through the front two (2) layers of the metal bumper for nut plate access. Do this to both sides of the vehicle.

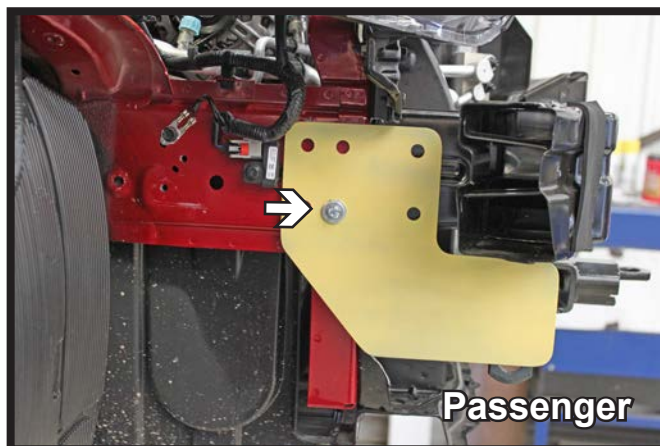
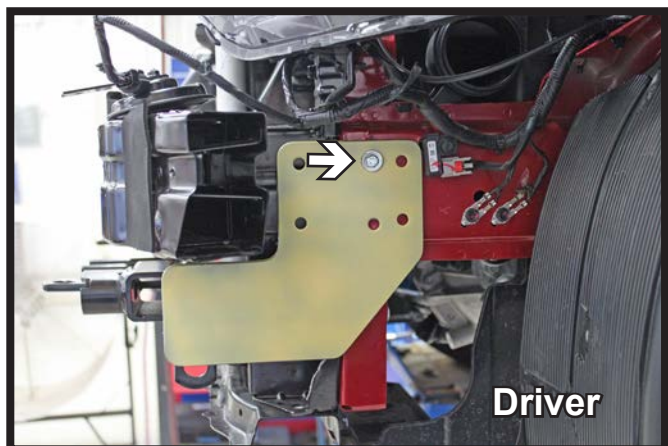

14. Mount the baseplate onto the vehicle using the existing holes on frame rails. On driver side insert a 6MM-1.00 x 45MM bolt into existing hole with 1/4" flat washer. On passenger side, insert a 6MM-1.00 30MM bolt into existing hole with 1/4" flat washer. Level the baseplate and tighten the hardware.

\*\* Use Loctite® Red on all bolt threads and tighten all bolts to the appropriate torque.

BX2338  
2012-17 Hyundai Accent GLS/SE (Includes Foglights)  
Installation Instructions

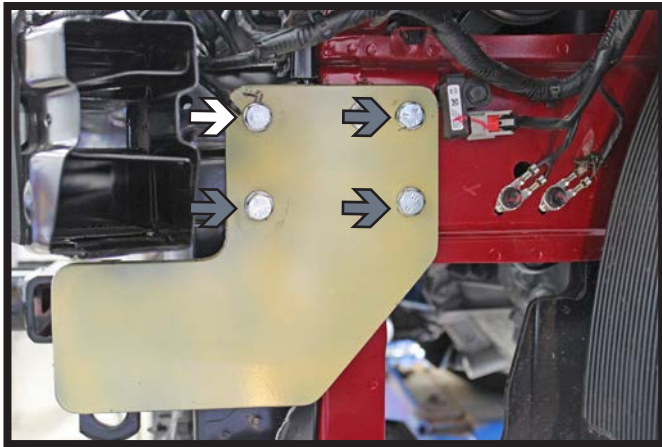

15. Using a 13/32" drill bit, drill top front hole on both sides of the vehicle thru the frame (white). Insure the baseplate remains level. Install 3/8"-16 x 1-1/4" bolts with 3/8" lock and flat washers into the holes and 3/8" nut plates in the frame. Fully tighten all hardware.

Continue drilling the remaining three (3) holes thru the frame (gray). Do this on both sides of the vehicle. Install 3/8"-16 x 1-1/4" bolts with 3/8" lock and flat washers into the holes and 3/8" nut plate in the frame. Fully tighten all hardware.

\*\* Use Loctite® Red on all bolt threads and tighten all bolts to the appropriate torque.

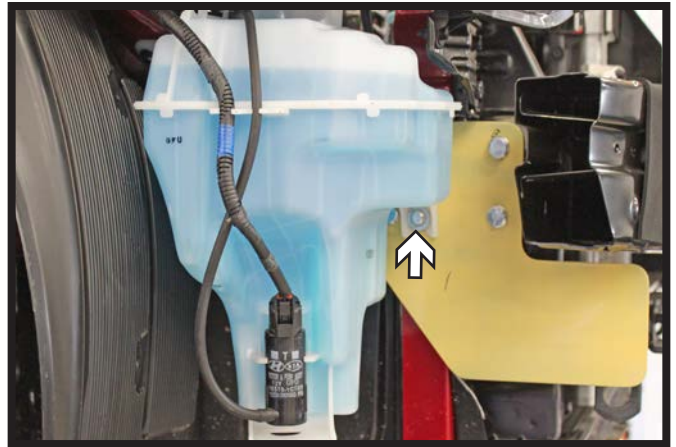

16. Remove the 6MM bolt and washer from the baseplate. Reinstall the washer reservoir, using the existing bolts in the back of the reservoir and reinstalling the 6MM bolt and washer into the baseplate. Reattach all fluid lines and electrical connections.

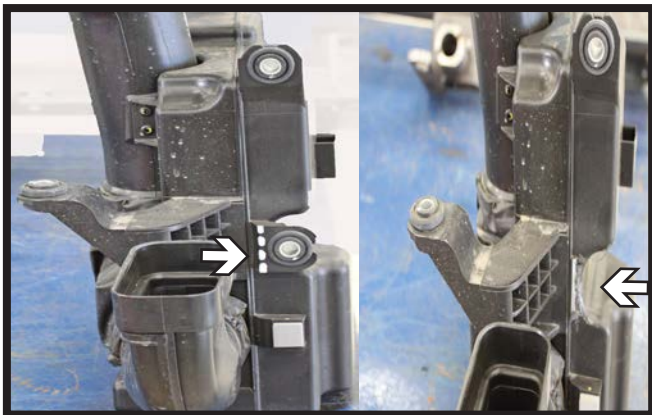

17. Trimming of the air baffle is required before reinstallation. With a utility knife, trim the lower tab off of the air baffle as shown. Remove the 6MM bolt and washer from the baseplate. Reinstall the baffle, using the existing bolts and reinstalling the 6MM bolt and washer into the baseplate.

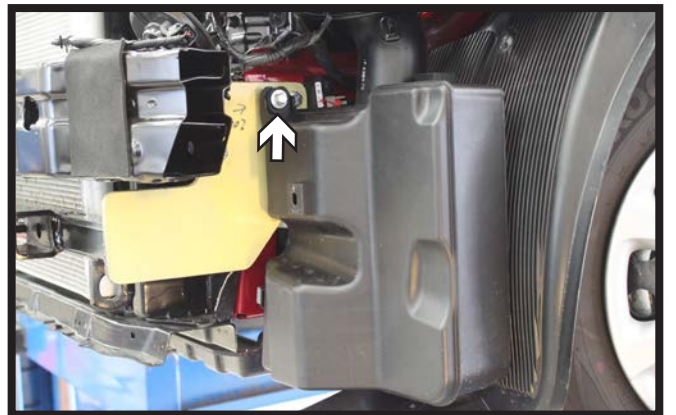



BX2338  
2012-17 Hyundai Accent GLS/SE (Includes Foglights)  
Installation Instructions

18. To reinstall the horn on driver side, flatten the notch at the end of the horn bracket by tapping with a hammer. Using the existing hole just below the headlight, insert 1/4"-20 x 3/4" hex bolt with 1/4"-20 hex flange whiz nut to attach horn bracket.



18. Attach the permanent baseplate safety cables to the provided convenience link on the baseplate. The photo above shows the recommended installation of the cables to frame of vehicle. Additional options may interfere with suggested mounting; in this case, secure the cables to a solid piece of the frame as described in the General Information sheet. Be sure the safety cables do not rub against any hoses or moving parts. Do this on **BOTH** sides of the vehicle.

19. Hold the fascia as close to its original position, mark and trim the fascia around the convenience links and attachment tabs. Reinstall the fascia and fascia cover.



BX2338  
2012-17 Hyundai Accent GLS/SE (Includes Foglights)  
Installation Instructions

**CUSTOMER SERVICE COMMITMENT**

Blue Ox® is committed to providing you with exceptional customer care throughout your lifetime with our products. Our team is here to assist you with any questions you may have regarding the performance of your product. Simply call (402) 385-3051 and you can speak with our technical service team.

Additionally, please visit our website to see which rallies our Destination America team will be attending. For a nominal fee, our service technician will service your towing system to ensure it's in proper working condition. Also, as a commitment to our customers, should you visit our factory, you can stay at our full service Blue Ox® campground at no charge along with enjoying a factory tour.

Again, thank you for being our customer and for the confidence you have shown in the performance of our products. It is because of customers like you we enjoy the success we have today.

© 2016 Blue Ox  
One Mill Road, Industrial Park  
Pender, Nebraska 68047  
Phone: (402) 385-3051  
Fax: (402) 385-3360  
[www.blueox.com](http://www.blueox.com)

# General Information

1. Ensure that your product(s) are registered online at [www.blueox.com](http://www.blueox.com). It is crucial to register your product(s) so that you may be alerted of product offerings, updates, upgrades, maintenance and safety bulletins, and/or recalls.
2. **It is the owner's responsibility to inspect all towing equipment for cracked welds, missing or worn parts and loose bolts before each towing trip.** Be sure to use Loctite® Red on all bolts and tighten to the recommended specifications.
3. **It is the owner's responsibility to hook up all towing equipment per manufacturer's instructions/recommendations.**
4. Remove the attachment tabs when not in use (if applicable).

## Notice To Baseplate Installer

### 1. It is YOUR responsibility to watch for:

- Oil cooler and air conditioner lines
- Electrical wires and hoses
- Missing parts or attaching points on the frame

\*\* If the baseplate is improperly installed and is against a wire or hose, it could cause fluid leaks or electrical shorts some time after the actual baseplate installation.

## Permanent Baseplate Safety Cable Installation

Permanent baseplate safety cables are strongly recommended when towing a vehicle with a tow bar. The principle function of the permanent baseplate safety cables is to prevent the towed vehicle from breaking loose in the event the connection between the frame of the towed vehicle and the baseplate fails or becomes disconnected. The cables must be connected from the baseplate to the frame rail or cross member of the vehicle's frame. The illustrations below show the possible arrangements recommended by Blue Ox®. Each permanent baseplate safety cable must have an adequate weight rating for the towing system. The weight rating of the two (2) cables together will not qualify.

***Do not mount the permanent baseplate safety cables against wires, hoses or brake lines.***

These permanent baseplate safety cables should remain installed as long as the baseplate is installed on the vehicle. Permanent baseplate safety cables are to be used in conjunction with, and NOT a replacement for legally required safety cables attaching the towed vehicle to the towing vehicle.

### OPTION #1

Permanent Baseplate Safety Cables to Cross Member or Frame of Towed Vehicle.



### OPTION #2

Permanent Baseplate Safety Cables to Cross Member or Frame of Towed Vehicle.

