



# BX2801

## 2012-17 Fiat 500 Pop/Lounge 2012-17 Fiat 500c Pop/Lounge Installation Instructions

**Attachment Tab Height: 13-1/2"**

**Attachment Tab Width: 18"**

**Serial Number**

**Please read BOTH these Installation Instructions and the General Instructions prior to installing or operating this equipment.**

- Blue Ox® towing products and accessories are intended to be installed by Blue Ox® Dealers who are familiar with our products and have the equipment and knowledge necessary to do "fit work". If needed, Blue Ox® Dealers can be found at [www.blueox.com](http://www.blueox.com) or by contacting our Customer Care Department at (402) 385-3051.
- Many Blue Ox® baseplates are designed to use existing holes and hardware to mount the baseplate to the towed vehicle. Even though bolts are there, do not assume they are adequate for baseplate mounting. Always use the hardware supplied in the hardware kit and existing hardware as specified in the installation instructions.

### Bolt Torque Specifications

Torque in Foot-Pounds for Inch Bolts

Bolt Size	Grade 5	Grade 8
1/4"	10	14
5/16"	19	29
3/8"	33	47
7/16"	54	78
1/2"	78	119
5/8"	154	230
3/4"	257	380



If the front of your vehicle looks different than this, please contact us at (402)385-3051.

**Reference your vehicle owner's manual for manufacturer's towing specifications.**

### Bolt Torque Specifications

Torque in Foot-Pounds for Metric Bolts

Bolt Size	Grade 8.8	Grade 10.9
6MM	6	8
8MM	16	22
10MM	31	40
12MM	54	70
14MM	89	117
16MM	161	230
18MM	222	318



## WARNING

Failure to read and follow these instructions could result in separation of the towed vehicle from the tow bar, causing property damage, loss of towed vehicle, personal injury or death.

BX2801  
2012-17 Fiat 500 Pop/Lounge  
2012-17 Fiat 500c Pop/Lounge  
Installation Instructions

**Instruction Notes:** The fascia is removed and reinstalled for the baseplate installation. The air deflector and bumper horns are removed and not reinstalled for the baseplate installation. Some drilling and trimming is required.

Place all components that are removed on a flat, sturdy surface. All items will be reinstalled unless otherwise noted after the baseplate is installed.

The dimensional variations between otherwise identical vehicles can be considerable. While the baseplate was designed for easy installation, it may be necessary to tailor the baseplate slightly to compensate for vehicle manufacturer's tolerances.

The BX8869 Tail Light Wiring Kit is recommended for this vehicle. (Refer to page 7)

## ***NOTICE***

- Handling of some cosmetic parts when installing this product may require the use of protective covers, rags, specialty tools, etc. to prevent damage.
- When using power drills be aware of the dangers of torque and drill bit length.
- When using a reciprocating saw be aware of objects behind the cutting surface.
- Use a good quality paint to spray cut edges of frame to prevent rusting.
- Be sure that **ALL** electrical connections are plugged in and accessories are functioning properly before reinstalling the fascia.
- The baseplate is computer tested to your vehicle's GVWR, exceeding this weight will void the manufacturer's warranty.
- Be sure to use a sufficient amount of Loctite® Red on all bolt threads before tightening. Tighten all bolts according to the torque chart provided.
- Dealer or installer be certain the user receives these instruction sheets.
- If the baseplate is in an accident, it must be replaced. **DO NOT** use it again! An accident can cause unseen damage and using it again could result in more damage or serious injury. **DO NOT** use the baseplate if it is damaged or missing parts.

**BX2801**  
**2012-17 Fiat 500 Pop/Lounge**  
**2012-17 Fiat 500c Pop/Lounge**  
**Installation Instructions**

**Tools Required**

Large Vise Grip  
 Hammer  
 Reciprocating Saw  
 Utility Knife  
 Phillips Screwdriver  
 Torque Wrench  
 Drill  
 Tape Measure  
 Loctite® RED  
 13/32" Drill Bit  
 8MM Socket  
 10MM Socket  
 14MM Socket  
 9/16" Socket  
 T30 Torx

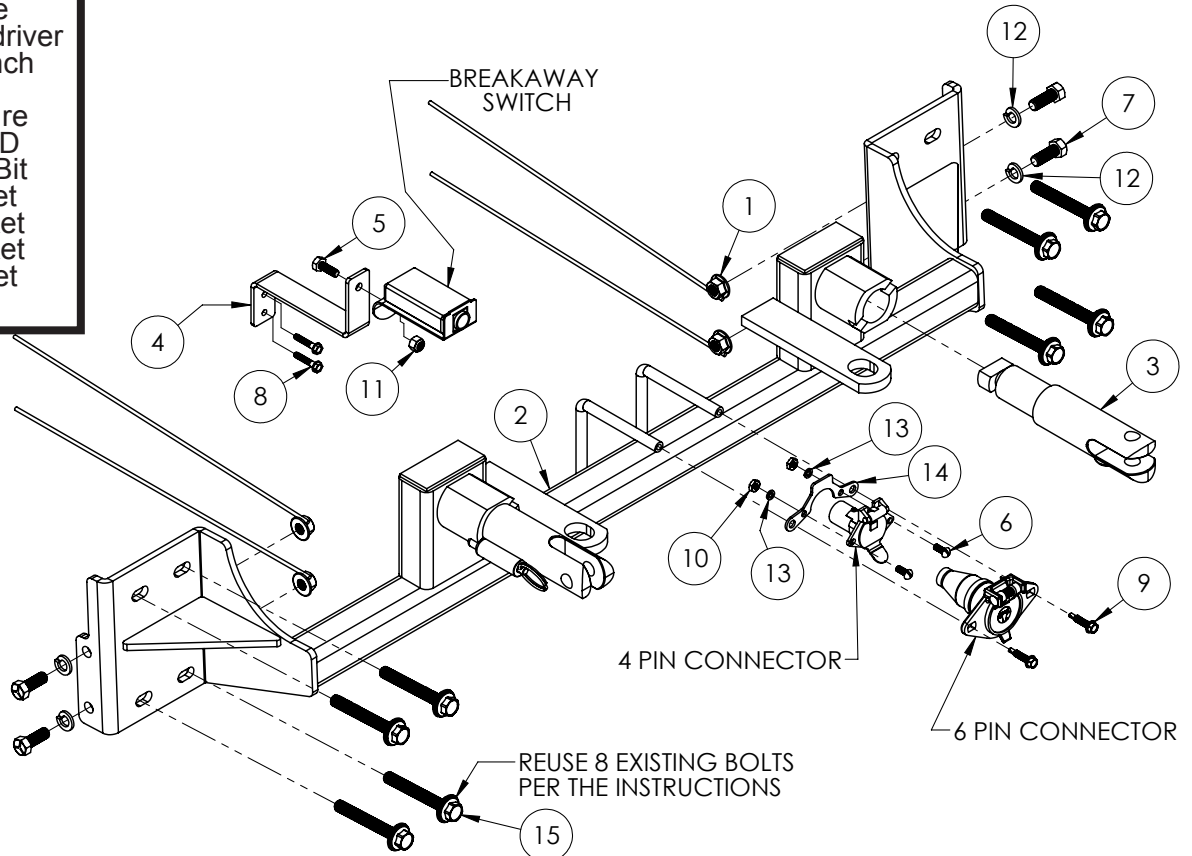

Item No.	Part No.	Description	Qty.
1.....	61-4978.....	3/8"-16 Nut w/ 14" Wire.....	4
2.....	61-7074.....	BX2801 Baseplate.....	1
3.....	62-3468.....	Attachment Tab.....	2
4.....	102-7197.....	Breakaway Bracket.....	1
5.....	201-0050.....	1/4"-20 x 3/4" Hex Head Bolt, Grade 5, ZP.....	1
6.....	201-0192.....	#10-32 x 1/2" Slot Round Head Screw.....	2
7.....	201-0443.....	3/8"-16 x 1" Hex Head Bolt, Grade 5, ZP.....	4
8.....	201-0654.....	#10-16 x 1" Self Drilling Screw, ZP.....	2
9.....	201-0979.....	#12-14 X 1" Self Drilling Screw, ZP.....	2
10.....	202-0047.....	#10-32 Hex Nut.....	2
11.....	202-0102.....	1/4"-20 Hex Nylon Nut, ZP.....	1
12.....	203-0010.....	3/8" Lock Washer, ZP.....	4
13.....	203-0054.....	#10 Lock Washer.....	2
14.....	299-0685.....	Electrical Bracket, ZP.....	1
15.....	Existing.....	10 MM Bolt.....	8
16.....	226-0046(not shown).....	Class III Safety Cables.....	2
17.....	229-0359(not shown).....	3/8" Quicklink, ZP.....	2
18.....	290-0437(not shown).....	Receiver Cap Plug.....	2

**Important:**

Use only genuine factory replacement parts on your baseplate. Do **NOT** substitute homemade or non-typical parts. If a bolt is lost or in need of replacement, for your safety and the preservation of your baseplate, be sure to use a replacement bolt of the same grade (In most cases it will be Grade 5, please reference the parts list above). Replacement parts may be ordered through your nearest Blue Ox® Dealer or Distributor. Failing to follow and/or altering these installation instructions in either installation or required equipment will void the manufacturer's warranty. Towing behind a non-motorized vehicle will void the warranty.

BX2801  
2012-17 Fiat 500 Pop/Lounge  
2012-17 Fiat 500c Pop/Lounge  
Installation Instructions



1. Using a T30 Torx, remove the four (4) screws from the top edge of the fascia.

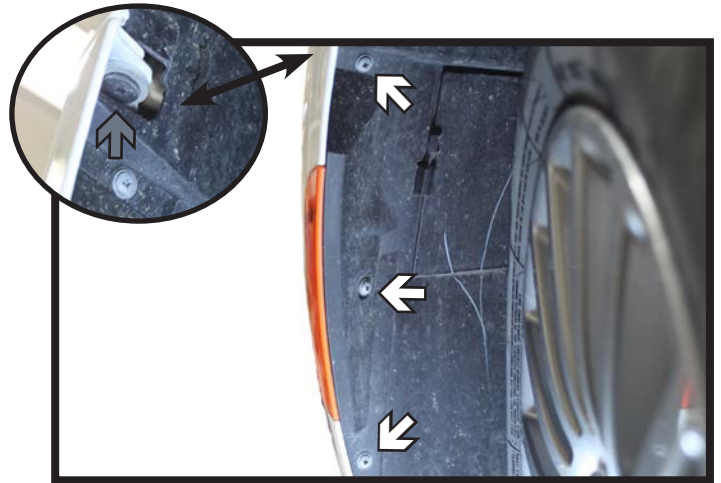

2. In the wheel well, using a Phillips screwdriver, remove the three (3) screws (white). In upper corner of the wheel well, using a T30 Torx, remove the one (1) screw (gray). Do this to both sides of the vehicle.



3. Using a Phillips screwdriver, remove one (1) screw from the bottom corner of the fascia. Do this to both sides of the vehicle.



4. Across the center on the underside of the vehicle, use a T30 Torx to remove three (3) screws. **DO NOT** remove the silver screw.



BX2801  
2012-17 Fiat 500 Pop/Lounge  
2012-17 Fiat 500c Pop/Lounge  
Installation Instructions

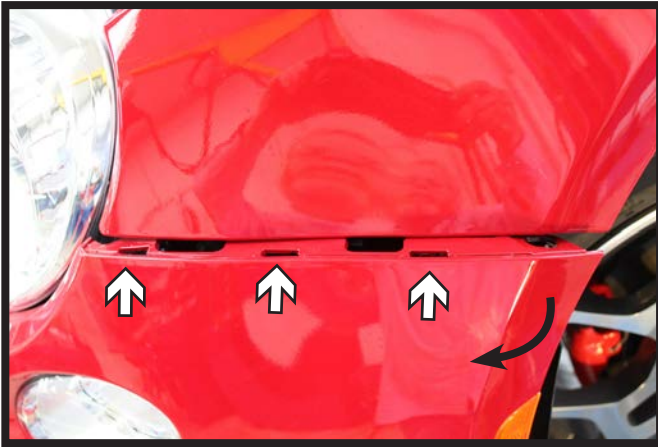

5. Unclip the fascia on the side. Once the fascia has been released, unplug all electrical connections. Next, firmly pull the fascia outward to remove. Set the fascia aside.

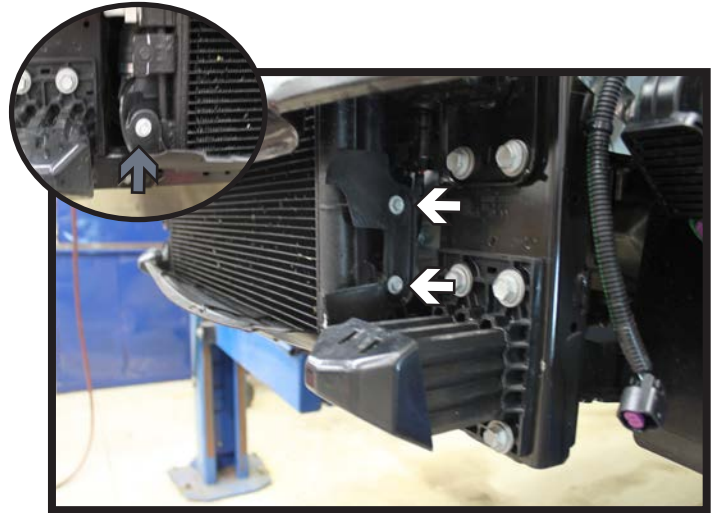

6. Remove the air deflector, use a 8MM socket to remove the two (2) screws on the driver side (white) and the one (1) screw on the passenger's side (gray). The deflector will NOT be reinstalled.

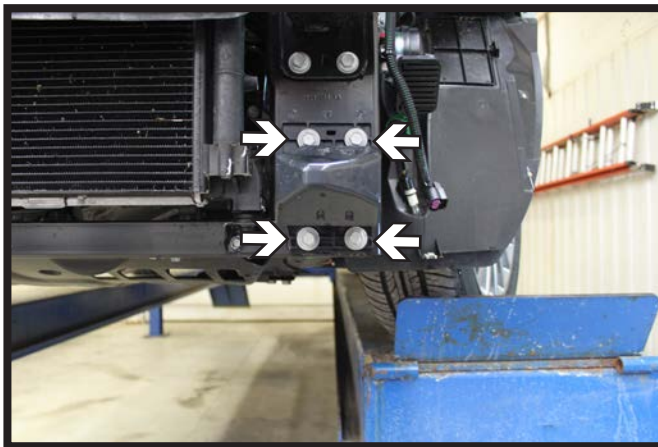

7. Using a 14MM socket, remove the four (4) lower bolts in the bumper horn bracket. Do this on both sides of the vehicle. These brackets will NOT be reinstalled.

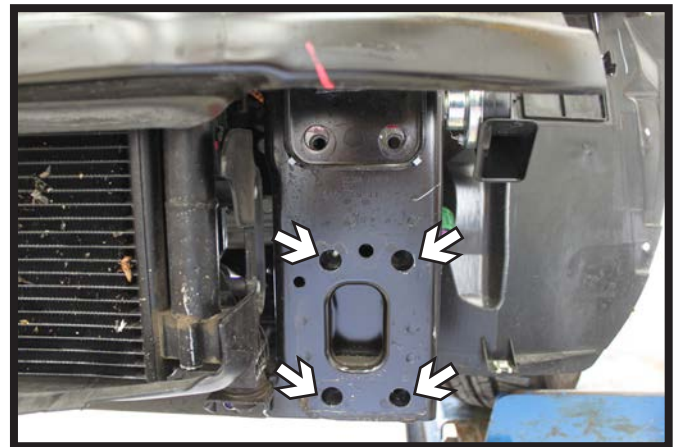

8. Align the baseplate with the four (4) holes and use the existing bolts to secure the baseplate. Do this on both sides of the vehicle.

**\*\* Use Loctite® Red on all bolt threads and tighten all bolts to the appropriate torque.**

BX2801  
2012-17 Fiat 500 Pop/Lounge  
2012-17 Fiat 500c Pop/Lounge  
Installation Instructions

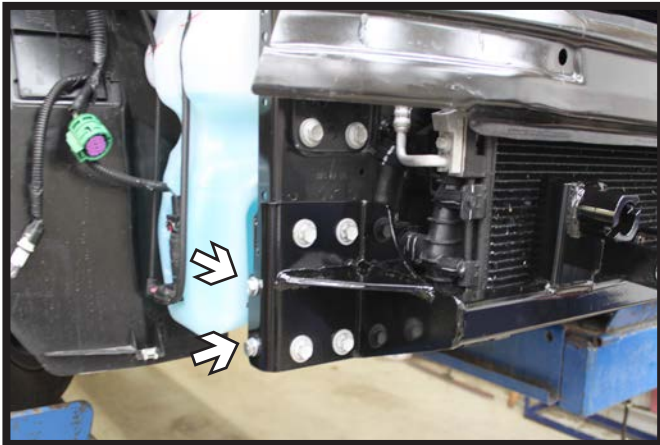

9. Using a 13/32" drill bit and the baseplate as a template, drill the two (2) side holes. Insert the 3/8"-16 x 1" bolts, 3/8" lock washers and 3/8"-16 nuts w/wires. Do this on both sides of the vehicle.

\*\* Use Loctite® Red on all bolt threads and tighten all bolts to the appropriate torque.

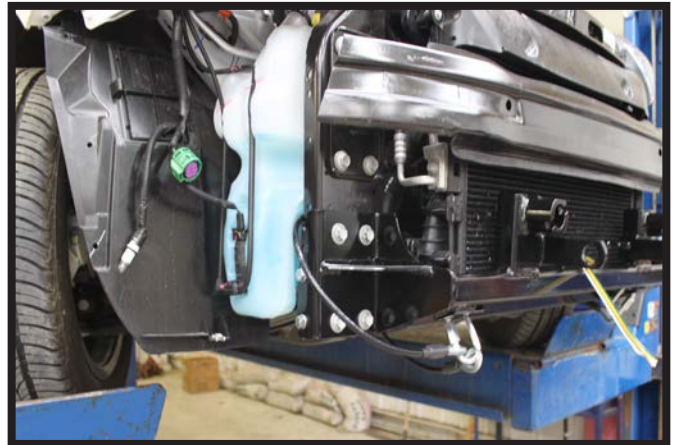

10. Attach the permanent baseplate safety cables to the provided convenience link on the baseplate. The photo above shows the recommended installation of the cables to frame of vehicle. Additional options may interfere with suggested mounting; in this case, secure the cables to a solid piece of the frame as described in the General Information sheet. Be sure the safety cables do not rub against any hoses or moving parts. Do this on **BOTH** sides of the vehicle.



11. Hold the fascia as close to its original position, mark and trim the fascia around the convenience links and attachment tabs. Reinstall the fascia.

BX2801  
2012-17 Fiat 500 Pop/Lounge  
2012-17 Fiat 500c Pop/Lounge  
Installation Instructions

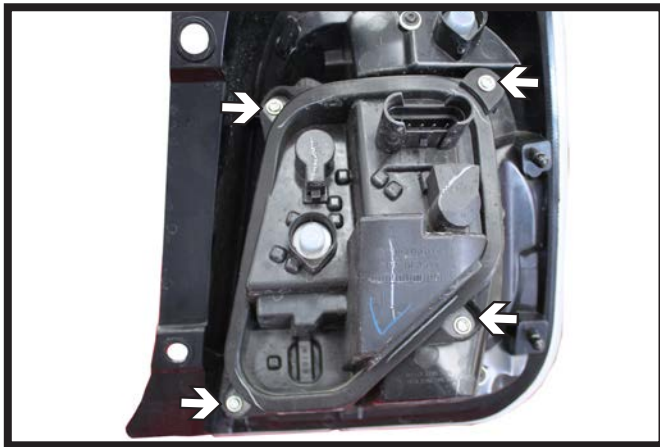

12. Possible location for BX8869 wiring kit: On the side of the tail light, using a T20 Torx remove the four (4) screws. Remove the back piece. Using a 1/2" drill bit, drill a hole in the plastic piece. Put the wires through the hole and silicon around it. Do this on both sides.

## CUSTOMER SERVICE COMMITMENT

Blue Ox® is committed to providing you with exceptional customer care throughout your lifetime with our products. Our team is here to assist you with any questions you may have regarding the performance of your product. Simply call (402) 385-3051 and you can speak with our technical service team.

Additionally, please visit our website to see which rallies our Destination America team will be attending. For a nominal fee, our service technician will service your towing system to ensure it's in proper working condition. Also, as a commitment to our customers, should you visit our factory, you can stay at our full service Blue Ox® campground at no charge along with enjoying a factory tour.

Again, thank you for being our customer and for the confidence you have shown in the performance of our products. It is because of customers like you we enjoy the success we have today.

© 2016 Blue Ox  
One Mill Road, Industrial Park  
Pender, Nebraska 68047  
Phone: (402) 385-3051  
Fax: (402) 385-3360  
www.blueox.com



# General Information

1. Ensure that your product(s) are registered online at [www.blueox.com](http://www.blueox.com). It is crucial to register your product(s) so that you may be alerted of product offerings, updates, upgrades, maintenance and safety bulletins, and/or recalls.
2. **It is the owner's responsibility to inspect all towing equipment for cracked welds, missing or worn parts and loose bolts before each towing trip.** Be sure to use Loctite® Red on all bolts and tighten to the recommended specifications.
3. **It is the owner's responsibility to hook up all towing equipment per manufacturer's instructions/recommendations.**
4. Remove the attachment tabs when not in use (if applicable).

## Notice To Baseplate Installer

### 1. It is YOUR responsibility to watch for:

- Oil cooler and air conditioner lines
- Electrical wires and hoses
- Missing parts or attaching points on the frame

\*\* If the baseplate is improperly installed and is against a wire or hose, it could cause fluid leaks or electrical shorts some time after the actual baseplate installation.

## Permanent Baseplate Safety Cable Installation

Permanent baseplate safety cables are strongly recommended when towing a vehicle with a tow bar. The principle function of the permanent baseplate safety cables is to prevent the towed vehicle from breaking loose in the event the connection between the frame of the towed vehicle and the baseplate fails or becomes disconnected. The cables must be connected from the baseplate to the frame rail or cross member of the vehicle's frame. The illustrations below show the possible arrangements recommended by Blue Ox®. Each permanent baseplate safety cable must have an adequate weight rating for the towing system. The weight rating of the two (2) cables together will not qualify.

***Do not mount the permanent baseplate safety cables against wires, hoses or brake lines.***

These permanent baseplate safety cables should remain installed as long as the baseplate is installed on the vehicle. Permanent baseplate safety cables are to be used in conjunction with, and NOT a replacement for legally required safety cables attaching the towed vehicle to the towing vehicle.

### OPTION #1



### OPTION #2

