



The Sign of Comfort

**USA**  
SERVICE OFFICE  
Dometic Corporation  
509 South Poplar Street  
LaGrange, IN 46761  
260-463-4858

**CANADA**  
Dometic Dist.  
866 Langs Dr.  
Cambridge, Ontario  
CANADA N3H 2N7  
519-653-4390

**For Service Center  
Assistance Call:**  
800-544-4881

**VENT INSTRUCTIONS  
INSTALLATION SUPPLEMENT  
and  
Application Guide  
FOR DOMETIC REFRIGERATORS  
As Required by the American/Canadian Gas Associations**

**INSTALLATION SUPPLEMENT**

**REFRIGERATOR  
VENT  
Application  
Guide**

Form No. 3308666.001 8/03  
(French 3308667.009)  
©2003 Dometic Corporation  
LaGrange, IN 46761

**Important: These instructions  
must stay with unit.  
Owner read carefully.**

## **SAFETY INSTRUCTIONS**

This manual has safety information and instructions to help users eliminate or reduce the risk of accidents and injuries.

### **RECOGNIZE SAFETY INFORMATION**



This is the safety-alert symbol. When you see this symbol in this manual, be alert to the potential for personal injury.

Follow recommended precautions and safe operating instructions.

### **UNDERSTAND SIGNAL WORDS**

A signal word, **WARNING OR CAUTION** is used with the safety-alert symbol. They give the level of risk for potential injury.

**! WARNING** indicates a potentially hazardous situation which, if not avoided, could result in death or serious injury.

**! CAUTION** indicates a potentially hazardous situation which, if not avoided may result in minor or moderate injury.

**CAUTION** used without the safety alert symbol indicates, a potentially hazardous situation which, if not avoided may result in property damage.

Read and follow all safety information and instructions.

### **! WARNING**

**This manual must be read and understood before installation, adjustment, service, or maintenance is performed. This unit must be installed by a qualified service technician. Modification of this product can be extremely hazardous and could result in personal injury or property damage.**

## **1. GENERAL INSTRUCTIONS**

The vents outlined herein have been design certified by A.G.A. under ANSI Z21.19 Refrigerator Standard for installation in a mobile home or recreational vehicle and are approved by the Canadian Gas Association.

The certifications are, however, contingent on the installation being made in accordance with the following instructions as applicable.

### **In the U.S.A., the installation must conform with:**

1. National Fuel Gas Code ANSI Z223.1 (latest edition)
2. Manufactured Home Construction and Safety Standard, Title 24 CFR, Part 3280
3. Recreational Vehicles ANSI A119.2 (latest edition)

The unit must be electrically grounded in accordance with the National Electric Code ANSI/NFPA 70 (latest edition) when installed if an external alternating current electrical source is utilized.

4. Any applicable local code.

### **In Canada, the installation must conform with:**

1. Current CGA B 149 Gas Installation Codes
2. Current CSA Standard Z240.4 GAS-EQUIPPED RECREATIONAL VEHICLES AND MOBILE HOUSING
3. Any applicable local code

### **! WARNING**

**All joints in the enclosure must be sealed to prevent gas leakage into the living area. Clearance from the combustible materials must be maintained as shown in the cross-section views.**

## 2. VENTILATION

The installation shall be made in such a manner as to separate the combustion system from the living space of the mobile home or recreational vehicle. Louver openings for air supply or for venting of combustion products shall have a minimum dimension of 1/4 inch.

Proper installation requires one fresh air intake and one upper exhaust vent. The ventilation kits shown in this instruction manual have been certified for use with the refrigerator models listed in the Table. For approved vents and refrigerator vent options, see Pages 12 -16. The ventilation kits must be installed and used without modification. An opening toward the outside at floor level in the refrigerator compartment must be provided for ventilation of heavier-than-air fuel gases. The lower vent of the recommended kits is provided with proper size openings. The flow of combustion and ventilation air must not be obstructed.

The lower side vent is fitted with a panel which provides an adequate access opening for ready serviceability of the burner and control manifold of the refrigerator. This should be centered on the back of the refrigerator.

When installing the refrigerator, the installer must block the space between the storage cabinet and the top of the refrigerator, otherwise heat will become trapped in this space, making the top of the refrigerator hot, thus reducing the efficiency of the unit.

For additional instructions not covered in this manual, see Installation Instructions for the model of refrigerator being installed.

## 3. CERTIFIED INSTALLATIONS

**All options must have both an upper and lower side vent, or a roof vent matched with a lower vent.**

## 4. METHODS OF INSTALLATION

### OPTION NO. 1

**Consists of one roof vent and one lower side vent.**

Recommended for normal installations where natural draft ventilation is possible.

### OPTION NO. 2

**Consists of two side vents.**

Natural draft ventilation on smaller single-door models where Installation Option No. 1 is **NOT** possible.

### OPTION NO. 3

#### The Innovator Refrigerator Ventilator System

For optimum performance and where Installation Options No. 1 and 2 are **NOT** possible:

- A. Consists of innovator power ventilator kit, one floor vent and one roof vent for **double door** and **side-by-side** refrigerators.
- B. Consists of innovator power ventilator kit and two side vents for **single door** refrigerators.
- C. Consists of innovator power ventilator kit and two plastic side vents for **single door** models.
- D. Consists of innovator power ventilator kit and two side vents for double door **6 ft.**, **8 ft.**, and **10 ft.** models.
- E. Consists of innovator power ventilator kit and two side vents for **side-by-side** models.

### OPTION NO.4

#### Refrigerator installation in slide-out room

For optimum performance in a slide-out room where installation of a roof vent is not possible:

- A. Consists of single door refrigerator with pre-installed innovator power ventilator and two side vents.
- B. Consists of double door refrigerator with pre-installed innovator power ventilator and two side vents.
- C. Consists of side-by-side refrigerator with pre-installed innovator power ventilator and two side vents.
- D. Consists of side-by-side refrigerator with pre-installed innovator power ventilator and two side vents in an extra deep alcove.

## OPTION 1

(Dimensions in Inches)

Model No.	A*	B	C	D***	Max. Dim.	Min. Dim.	Max. Dim.
NDR1062	63-3/4	24	59-15/16	23-11/16	8	0	1
NDR1292	65	24	59-1/16	32-3/4	8	0	1
NDR1402	69-18	26-1/16	63-3/16	32-3/4	8	0	1
NDR1492	65	24	59-1/16	36-1/2	8	0	1
RM2352	31	21-3/8	29-3/4	20-1/2	8	0	1
RM2353	31	21-3/8	29-3/4	20-1/2	8	0	1
RM2410	34	24	32-7/16	21-13/16	8	0	1
RM2452	37-3/4	24	36-9/16	23-11/16	8	0	1
RM2453	37-3/4	24	36-9/16	23-11/16	8	0	1
RM2510	42	24	40-5/16	21-13/16	8	0	1
RM2551	44-1/2	24	42-5/8	23-11/16	8	0	1
RM2554	44-1/2	24	42-5/8	23-11/16	8	0	1
RM2620	57-3/4	24	49-17/32	21-13/16	8	0	1
RM2652	57-3/4	24	53-3/4	23-11/16	8	0	1
RM2662	57-3/4	24	53-3/4	23-11/16	8	0	1
RM2663	57-3/4	24	53-3/4	23-11/16	8	0	1
RM2820	63-3/4	24	55-7/16	23-11/16	8	0	1
RM2852	63-3/4	24	59-15/16	23-11/16	8	0	1
RM2862	63-3/4	24	59-15/16	23-11/16	8	0	1
RM3862	63-3/4	24	59-15/16	23-11/16	8	0	1

**Note:** See Pages 12 through 16 for approved Dometic Refrigerator Vent options.

**Note:** Options 1, 2, 3B, 3C, 3D, 3E & 4 require the floor of the refrigerator compartment to be flush with the inside opening of the vent frame.

**Note:** B, C & D inside dimensions are minimum installed dimensions as zero clearance is required.

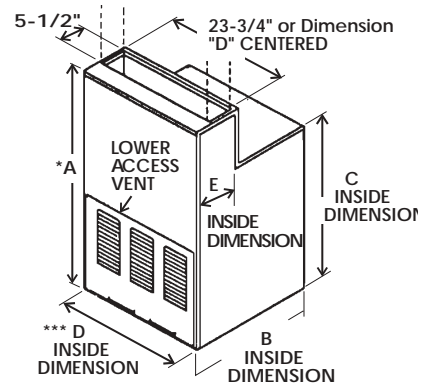
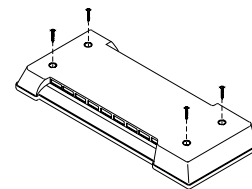
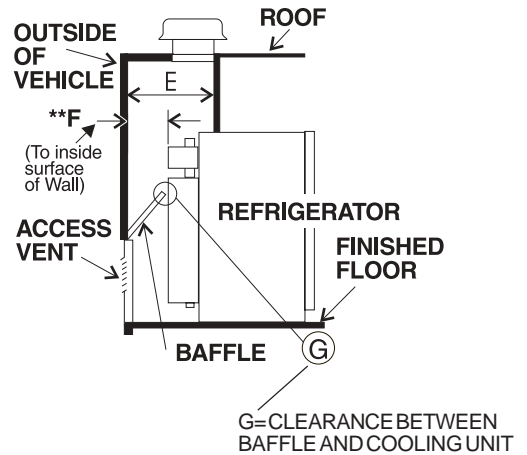
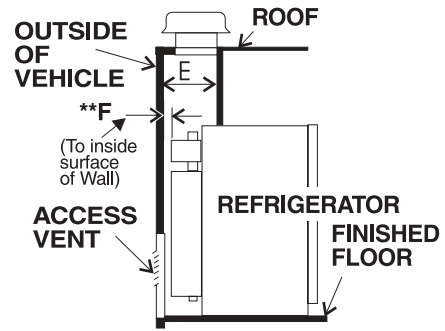

- \* 1. Dimension "A" is minimum. It is measured from the floor of the refrigerator compartment to the roof surface. This dimension may be increased for more efficient operation in warm temperatures.
- \*\* 2. When dimension "F" is exceeded by more than 1 inch, it is required to add "Baffle/s" as shown above lower access vent for more efficient operation in warm temperatures.
- \*\*\* 3. If the width of the refrigerator compartment (Dimension "D") is less than 23-3/4", cut vent to dimension "D". If the width of the refrigerator compartment (Dimension "D") is larger than 23-3/4", cut opening to 23-3/4" but position cutout to flue side of refrigerator.

**OPTION 2**

Model No.	A*	B	C	D	Max. Dim. E	Min. Dim. F**	Max. Dim. G
RM2193(1)	20-5/8	20-7/8	20-7/8	17-3/4	4	1	1
RM2193(2)	21-5/8	20-7/8***	20-7/8	17-3/4	4	1	1
RM2352	34	21-3/8	29-3/4	20-1/2	4	1	1
RM2353	34	21-3/8	29-3/4	20-1/2	4	1	1
RM2410	38	24	32-7/16	21-13/16	4	0	1
RM2452	37-3/4	24	36-9/16	23-11/16	4-1/2	0	1
RM2453	37-3/4	24	36-9/16	23-11/16	4-1/2	0	1
RM2510	38	24	40-5/16	21-13/16	4	0	1
RM2551	44-1/2	24	42-5/8	23-11/16	4	0	1
RM2554	44-1/2	24	42-5/8	23-11/16	4	0	1
RM4223(1)	21	24	20-29/32	19-9/16	4-1/2	0	1
RM4223(2)	22	24***	20-29/32	19-9/16	4-1/2	0	1

**Note:** See Pages 12 through 16 for approved Dometic refrigerator vent options.

(1) - Installation with metal side vents

(2) - Installation with plastic side vents

\*\*\* Vehicle wall thickness dimension will need to be increased if the vehicle wall thickness is less than 1-1/2 inches.

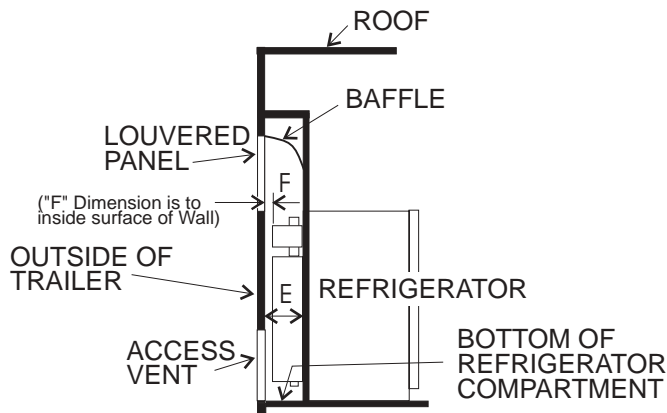
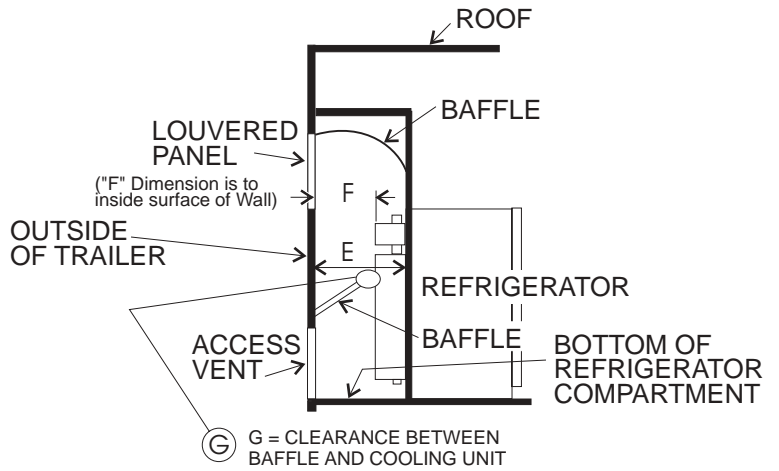
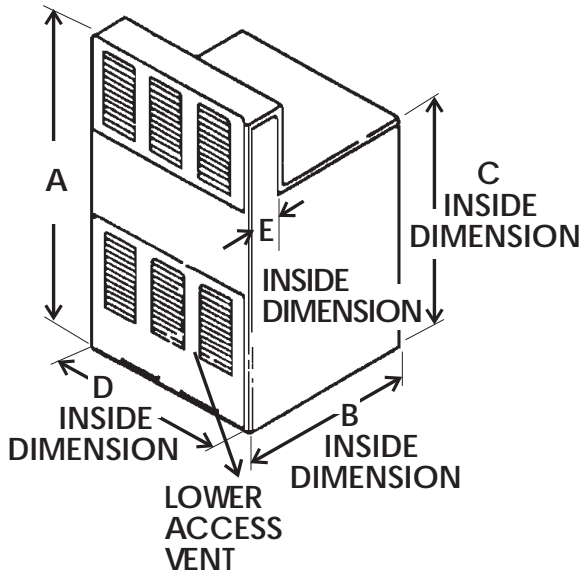

\*1. Dimension "A" is minimum. It is measured from the floor of the refrigerator compartment to the roof surface. This dimension may be increased for more efficient operation in warm temperatures.

\*\*2. When dimension "F" is exceeded, it is necessary to add "Baffle/s" as shown above lower access vent for more efficient operation in warm temperatures.

**Note:** B, C & D inside dimensions are minimum installed dimensions as zero clearance is required.

**Note:** Options 1, 2, 3B, 3C, 3D, 3E, & 4 require the floor of the refrigerator compartment to be flush with the inside opening of the vent frame.

**OPTION 3**  
**The Innovator Refrigerator**  
**Ventilation System**

**A. ISLAND INSTALLATION - REFRIGERATOR ACCESS (Rear)**

Using the Innovator Ventilation System in conjunction with below floor ventilation, a sealed access panel is required. Access is necessary to complete gas connections, first installation gas leak tests, and periodic service requirements at the rear of the refrigerator. If located within the vehicle interior, it shall be completely sealed to prevent gas leakage within the living space.

If the refrigerator is placed along the sidewall and floor ventilation is provided, rear access is still required. This door or panel should prevent water entry. The following are minimum sizes allowed for each series of refrigerator:

See installation instructions packaged with the Innovator Ventilation System (3108709.936 and 3108709.944), Patent No. 5,355,693.

**Important: Must be used with certified upper roof vent and installed per Option 1 Specifications.**

**Note:** See Pages 12 through 16 for approved Dometic refrigerator vent options.

MODEL SERIES	ACCESS PANEL DIMENSION	
	A	B
RM2620, RM2652, RM2662, RM2663 RM2820, RM2852, RM2862 RM3862 NDR1062	22"	14"
NDR1292	32"	16"
NDR1402, NDR1492	36"	16"

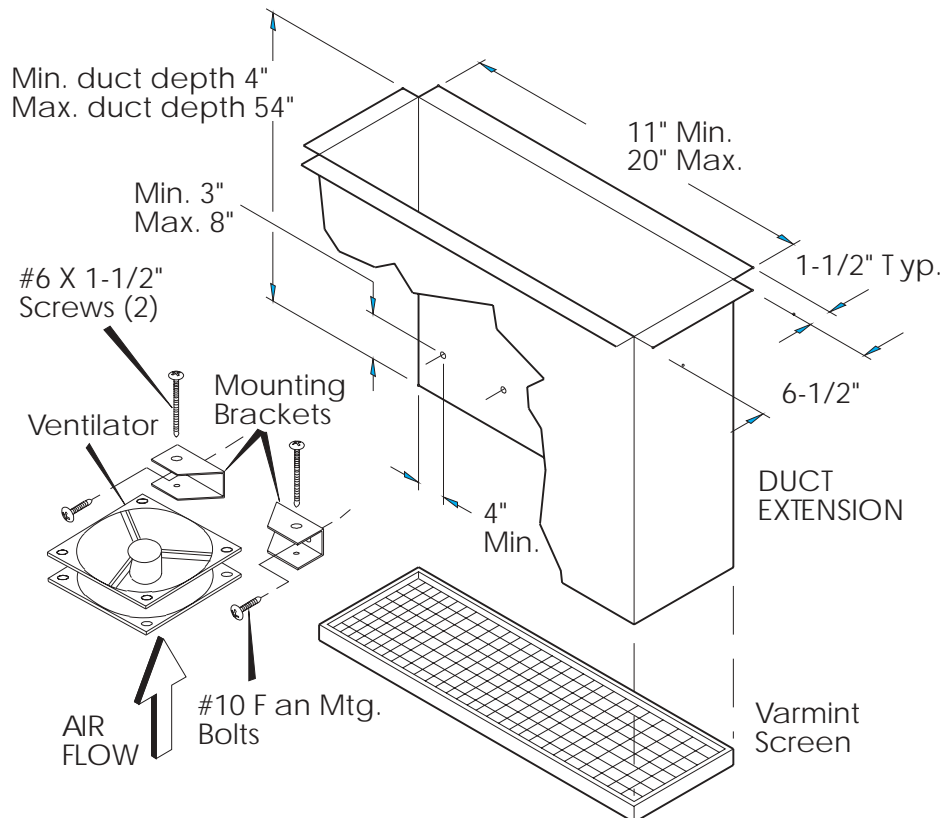
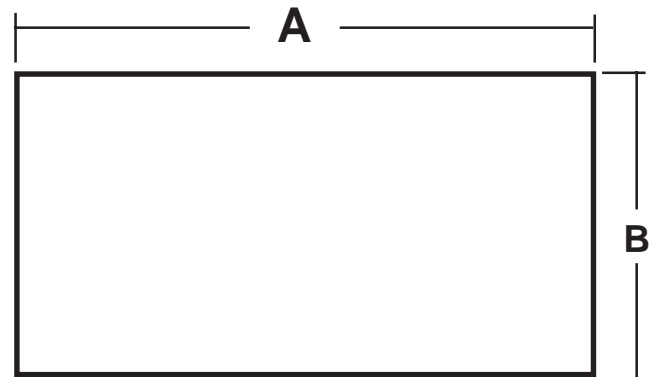

**OPTION 3**  
**The Innovator Refrigerator Ventilation System**

**B. THE INNOVATOR VENTILATION SYSTEM FOR SINGLE DOOR ABSORPTION REFRIGERATORS WITH TWO SIDE VENTS.**

This Innovator Ventilation System is for use with Dometic's **single door** refrigerators in applications where existing minimum vent heights are reduced. The table below shows the innovator vent height that can be used, when the innovator power ventilator kit is used. The innovator power ventilator kits purpose is to assist required air movement across the refrigerator condenser to ensure optimum performance.

**See Installation Instructions packaged with the Innovator Ventilation System 3108705.751, Patent and 3108705.744 (Patent No. 5,355,693).**

**Important: Must be used with certified upper and lower side vents and installed per Option 2 Specifications except for "A" min. dimension.**

**Note:** When lower vent frame is higher than the refrigerator compartment floor: 2 (two) holes 1-3/4 inches in diameter (1 sq in. per hole free area) and covered with (14 x 14 per inch min.) screen are required to vent the heavier than air gasses to the out-of-doors.

**Note:** See Pages 12 through 16 for approved Dometic Refrigerator vent options.

(Dimensions in Inches)

Model No.	Min. Innovator Vent Height A	Min. Dim. B	Max. Dim. C	Min. Dim. D*	Max. Dim. E
RM2193	20	20-7/8	4	1	1
RM4223	20	24-1/2	4-1/2	0	1
RM2352	34	21-3/8	4	0	1
RM2353	34	21-3/8	4	0	1
RM2410	33	24	4	0	1
RM2452	36	24	4-1/2	0	1
RM2453	36	24	4-1/2	0	1
RM2510	37	24	4	0	1
RM2551	44-1/2	24	4	0	1
RM2554	44-1/2	24	4	0	1

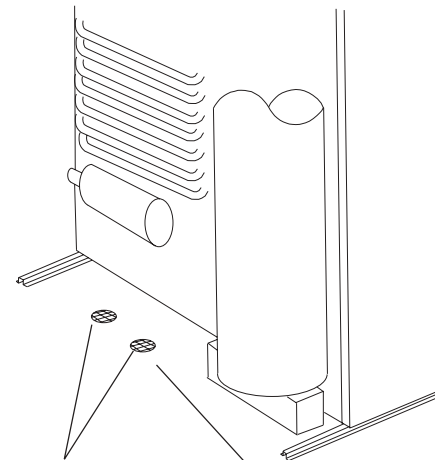
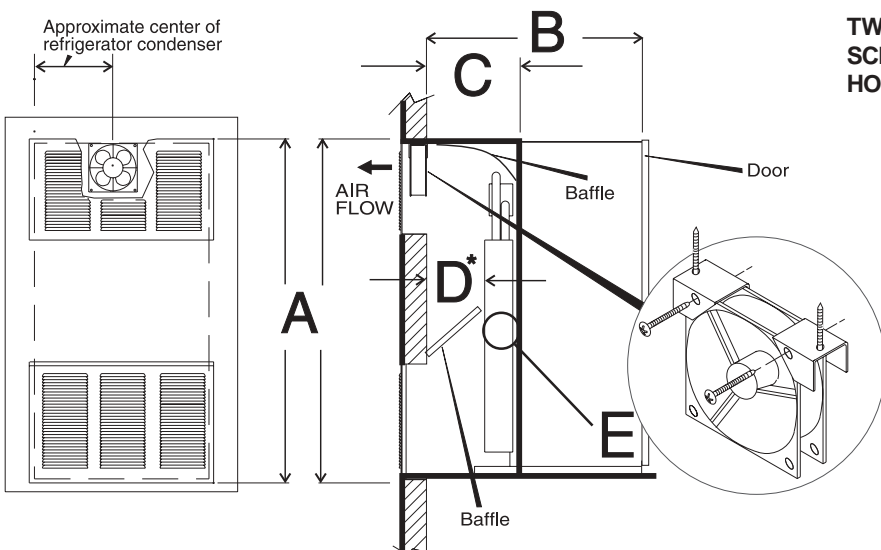

**TWO 1-3/4" DIA. SCREEN COVERED HOLES**

**HOLES MUST BE CLEAR OF ANY OBSTRUCTION**

\* When dimension "D" exceeds 1", it is necessary to add baffle (E) above lower access vent, as shown, for more efficient operation in warm temperatures.

**OPTION 3**  
**The Innovator Refrigerator Ventilation System**

**C. INNOVATOR VENTILATION SYSTEM FOR SINGLE DOOR REFRIGERATORS WITH 2 PLASTIC SIDE VENTS**

The Innovator Ventilation System is for use in Dometic's **4 ft.** and **5 ft.** refrigerators with two (2) plastic side vents. The table below shows the innovator vent height that can be used when the innovator power ventilator kit is used. The innovator power ventilator kits purpose is to assist required air movement across the refrigerator condenser to ensure optimum performance.

**Important: Must be used with certified side vents and installed per dimension below with Innovator ventilation system kit 3108705.751.**

**See Installation Instructions packaged with the Innovator Ventilation System (3108705.751), Patent No. 5,355,693.**

**Note:** See Pages 12 through 16 for approved Dometic refrigerator vent options.

(Dimensions in Inches)

Model No.	Min. Innovator Vent Height A	Min. Dim. +1/4 - 0 B	Min. Dim. C	Max. Dim. C	Max. Dim. D*	Max. Dim. E	Fan Height F
RM2452	36	24-3/4	5-1/8	8	3-1/2	1	**
RM2453	36	24-3/4	5-1/8	8	3-1/2	1	**
RM2551	42	24-3/4	5-1/8	8	3-1/2	1	**
RM2554	42	24-3/4	5-1/8	8	3-1/2	1	**

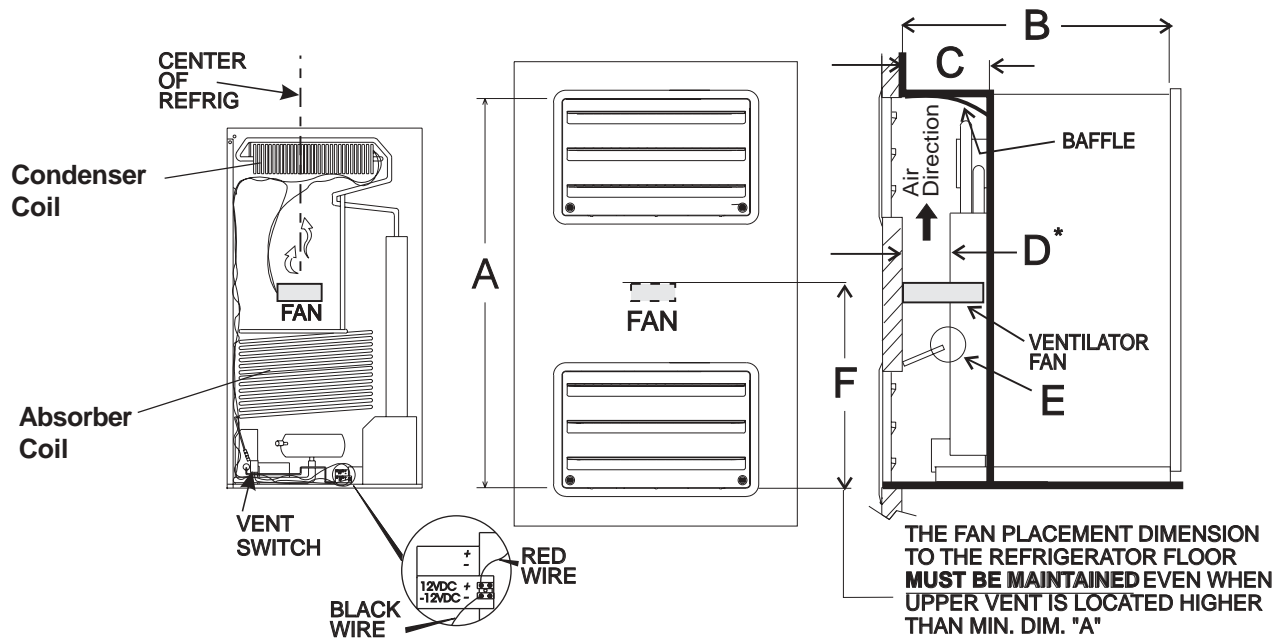

\* When dimension "D" exceeds 1", it is necessary to add baffle (E) above lower access vent, as shown, for more efficient operation in warm temperatures.

\*\* Fan mounting height should be determined by measuring 1/2 of the height of the refrigerator and centered in space between absorber coils and condenser coil.



**OPTION 3**  
**The Innovator Refrigerator Ventilation System**

**D. INNOVATOR VENTILATION SYSTEM FOR DOUBLE DOOR REFRIGERATOR WITH 2 SIDE VENTS**

The Innovator Ventilation System is for use in Dometic's **6 ft., 8 ft.** and **10 ft.** refrigerators with two (2) plastic side vents. The table below shows the innovator vent height that can be used when the innovator power ventilator kit is used. The innovator power ventilator kits purpose is to assist required air movement across the refrigerator condenser to ensure optimum performance.

**Important: Must be used with certified side vents and installed per dimension below with Innovator ventilation system kit 3108709.936 and 3108709.944.**

See Installation Instructions packaged with the Innovator Ventilation System (3108709.936 and 3108709.944), Patent No. 5,355,693.

**Note:** See Pages 12 through 16 for approved Dometic refrigerator vent options.

(Dimensions in Inches)

Model No.	Min. Innovator Vent Height A	Min. Dim. +1/4 -0 B	Min. Dim. C	Max. Dim. C	Max. Dim. D*	Max. Dim. E	Max. Dim. F
** RM2620	49	24-7/8	8-1/8	8	4-14	1	34-1/2
** RM2652	56	24-3/4	5-1/8	8	3-1/2	1	38-1/2
** RM2662	56	24-3/4	5-1/8	8	3-1/2	1	38-1/2
** RM2663	56	24-3/4	5-1/8	8	3-1/2	1	38-1/2
RM3662	56	24-3/4	5-1/8	8	3-1/2	1	38-1/2
RM3663	56	24-3/4	5-1/8	8	3-1/2	1	38-1/2
** RM2820	57	24-7/8	5-1/8	8	4-1/4	1	41-1/2
** RM2852	61	24-3/4	5-1/8	8	3-1/2	1	45-1/2
** RM2862	61	24-3/4	5-1/8	8	3-1/2	1	45-1/2
** RM3862	61	24-3/4	5-1/8	8	3-1/2	1	45-1/2
** NDR1062	61	24-3/4	5-1/8	8	3-1/2	1	45-1/2

\*\* **Note:** Models use Innovator ventilation system kit 3108709.936.

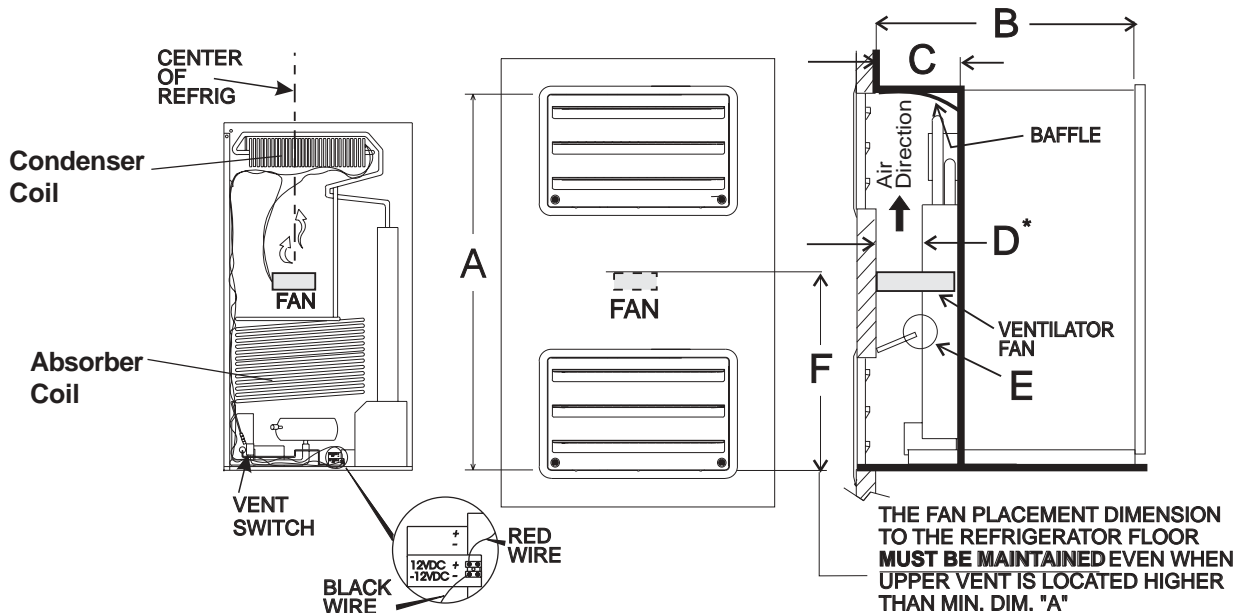

\* When dimension "D" exceeds 1", it is necessary to add baffle (E) above lower access vent, as shown, for more efficient operation in warm temperatures.

**The Innovator Refrigerator Ventilation System**

**E. INNOVATOR VENTILATION SYSTEM FOR SIDE-BY-SIDE REFRIGERATOR WITH 2 SIDE VENTS**

The Innovator Ventilation System is for use in Dometic's **side-by-side** refrigerators with two (2) plastic side vents. The table below shows the innovator vent height that can be used when the innovator power ventilator kit is used. The innovator power ventilator kits purpose is to assist required air movement across the refrigerator condenser to ensure optimum performance.

**Important: Must be used with certified side vents and installed per dimension below with Innovator ventilation system kit 3108709.936.**

**See Installation Instructions packaged with the Innovator Ventilation System (3108709.936), Patent No. 5,355,693.**

**Note:** See Pages 12 through 16 for approved Dometic refrigerator vent options.

(Dimensions in Inches)

Model No.	Min. Innovator Vent Height A	Min. Dim. +1/4 -0 B	Min. Dim. C	Max. Dim. C	Max. Dim. D*	Max. Dim. E	F
NDR1292	63	25	5-1/8	8	3-5/8	1	44-1/2
NDR1402	66	27-1/16	5-1/8	8	4-5/8	1	???
NDR1492	63	25	5-1/8	8	3-5/8	1	44-1/2

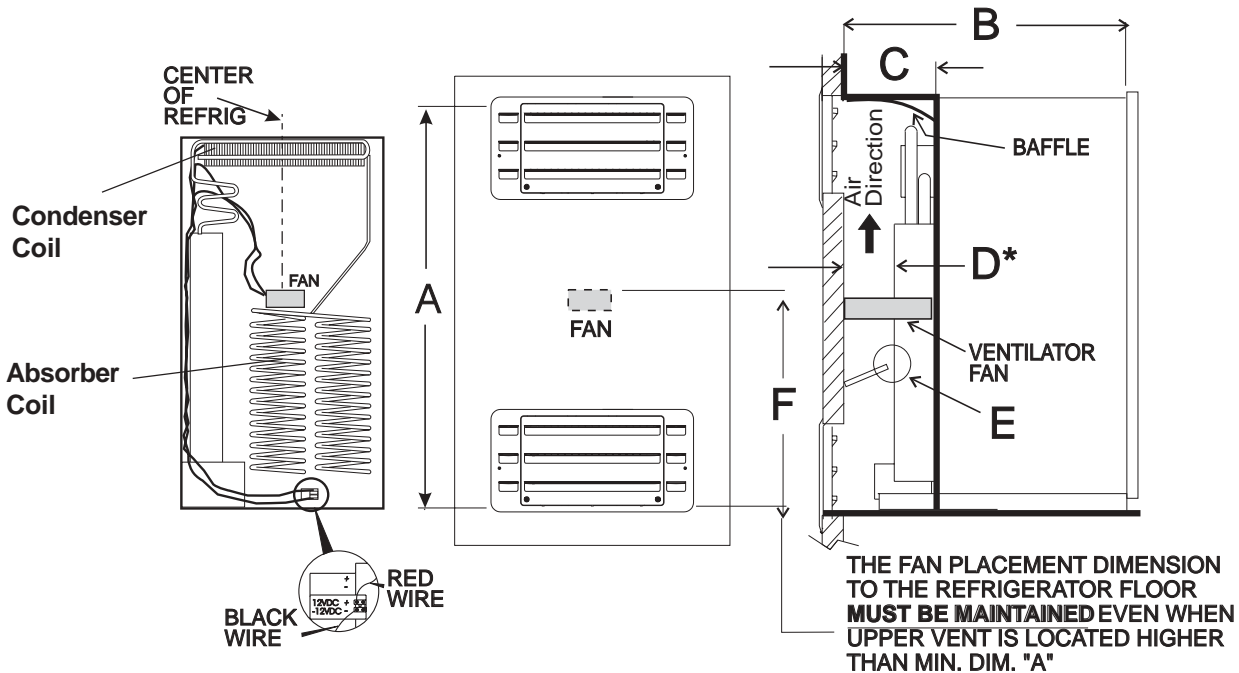

\* When dimension "D" exceeds 1", it is necessary to add baffle (E) above lower access vent, as shown, for more efficient operation in warm temperatures.

**OPTION 4**  
**Refrigerator installation in slide-out room**

**A. FOR SINGLE DOOR REFRIGERATOR WITH PRE-INSTALLED INNOVATOR POWER VENTILATOR AND TWO SIDE VENTS.**

See Option 3 B & C on pages 7 and 8.

See Installation Instructions packaged with the Innovator Ventilation System (3108705.751), Patent No. 5,355,693.

**B. FOR DOUBLE DOOR REFRIGERATOR WITH PRE-INSTALLED INNOVATOR POWER VENTILATOR AND TWO SIDE VENTS.**

See Option 3 D on page 9.

**C. FOR SIDE-BY-SIDE REFRIGERATOR WITH PRE-INSTALLED INNOVATOR POWER VENTILATOR AND TWO SIDE VENTS.**

See Option 3 E on page 10.

See Installation Instructions packaged with the Innovator Ventilation System (3108709.936), Patent No. 5,355,693.

**D. CONSISTS OF SIDE-BY-SIDE REFRIGERATOR WITH PRE-INSTALLED INNOVATOR POWER VENTILATOR AND TWO SIDE VENTS IN AN EXTRA DEEP ALCOVE.**

The Innovator Ventilation System used in Option 3 "E" for Dometic's **side-by-side** refrigerators with two (2) plastic side vents, can be installed in an alcove where the depth exceeds the maximum dimension to the back wall of the refrigerator, if it is incorporated with a box baffle.

The table below shows the clearances required, when the box baffle is used. The innovator power ventilator kits purpose is to assist required air movement across the refrigerator condenser to ensure optimum performance.

**Important: Must be used with certified side vents and installed per dimension below with Innovator ventilation system kit 3108709.936.**

See Installation Instructions packaged with the Innovator Ventilation System (3108709.936), Patent No. 5,355,693.

**Note:** See Pages 12 through 16 for approved Dometic refrigerator vent options.

(Dimensions in Inches)

Model No.	Min. Innovator Vent Height A	Min. Dim. +1/4 -0 B	Max. Dim. +1/4 -0 B	Min. Dim. C	Max. Dim. C	Max. Dim. D*	Max. Dim. E	Fan Height F
NDR1292	63	25	31	5-1/8	14	6	1	44-1/2
NDR1402	66	27-1/16	33-1/16	5-1/8	14	6	1	???
NDR1492	63	25	31	5-1/8	14	6	1	44-1/2

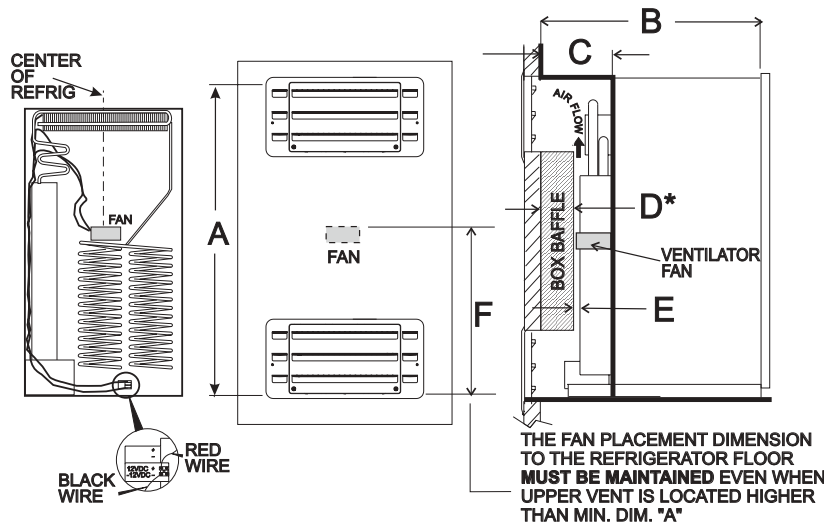

\* Place box baffle on sidewall to extend with in 1" of refrigerator coils to redirect airflow. Box Baffle must be constructed out of materials rated to withstand temperatures of 104 °F and higher.

# APPROVED DOMETIC REFRIGERATOR VENTS

## VENT NO. 1

### DOMETIC PLASTIC ROOF VENT

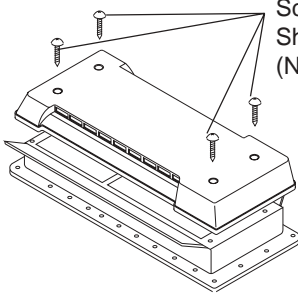

Screws #10 x 2"  
Sheet Metal  
(Not Supplied)

**Base**

Part No. 3103633.016	Gray
Part No. 3103633.024	Polar White
Part No. 3103633.032	Colonial White
Part No. 3103633.107	Bright White
Part No. 3103633.123	Mende Polar White

**Cap**

Part No. 3103634.014	Gray
Part No. 3103634.022	Polar White
Part No. 3103634.030	Colonial White
Part No. 3103634.105	Bright White
Part No. 3103634.121	Mende Polar White

(CUTOUT: 5-1/2" X 23-3/4")

Base Part No. 3103633.XXX\*  
Cap Part No. 3103634.XXX\*

## VENT NO. 2

### DOMETIC (UPPER/LOWER) PLASTIC SIDE VENT

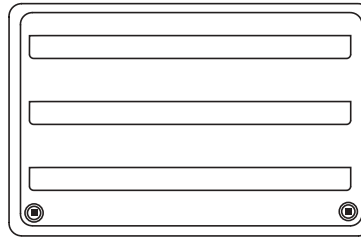

(CUTOUT: 13-3/4" x 21-9/16")

Part No. 3109350.XXX \*

Part No. 3109350.011	Polar White
Part No. 3109350.029	Colonial White
Part No. 3109350.039	Nutra White
Part No. 3109350.045	Mende Polar White
Part No. 3109350.052	Bright White
Part No. 3109350.056	Gray

## VENT NO. 3

### DOMETIC UPPER SIDE VENT (Metal)

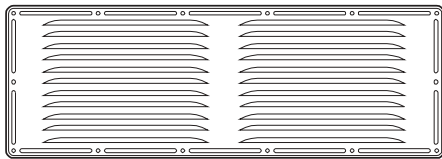

(CUTOUT: 7-3/4" X 19-1/4")

**RM 123A**

Part No. 3100451.016	Colonial White
Part No. 3100451.024	Polar White
Part No. 3100451.065	Mill Finish
Part No. 3100451.073	Nutra White

## VENT NO. 4

### DOMETIC UPPER SIDE VENT

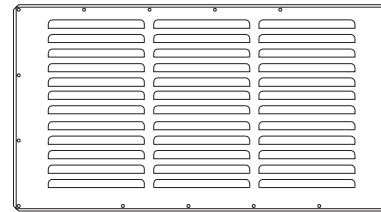

(CUTOUT: 10-1/4" x 21")

**RM122**

Part No. 8030122320 Polar White

## VENT NO. 5

### DOMETIC LOWER SIDE VENT

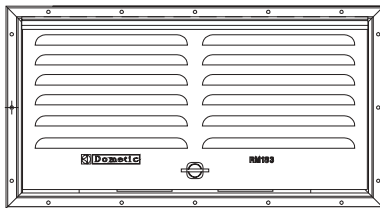

(CUTOUT: 9-11/16" x 19-1/4")

**RM183**

Part No. 3102364.019	Nutra White
Part No. 8030211322	Polar White
Part No. 8030211332	Colonial White

## VENT NO. 6

### DOMETIC (UPPER/LOWER) PLASTIC SIDE-BY-SIDE VENT

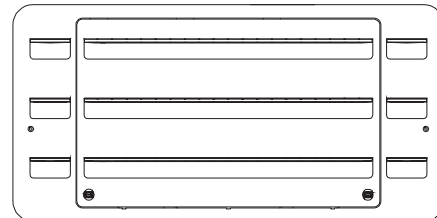

(CUTOUT: 13-5/8" X 28-5/8")

Part No. 3109349.005	Polar White
Part No. 3109349.039	Bright White
Part No. 3109349.047	Mende Polar White

# APPROVED DOMETIC REFRIGERATOR VENTS

## **VENT NO. 7**

**THE INNOVATOR REFRIGERATOR VENTILATION SYSTEM (PATENT #5,355,693)**  
For Use with Single Door Refrigerators

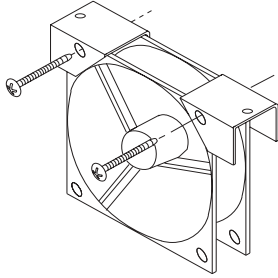

Part No. 3108705.751 **WITH** ON/OFF Switch

## **VENT NO. 8**

**THE INNOVATOR REFRIGERATOR VENTILATION SYSTEM (PATENT #5,355,693)**  
For Use with Dometic's 6 cu. ft. or larger models with Multiple Venting Applications (excluding Models RM2612, RM2652, RM2812, & RM2852)

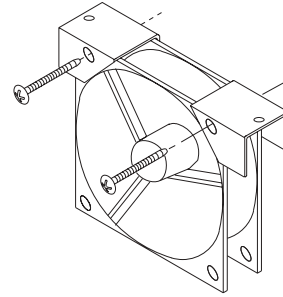

Part No. 3108705.744 **WITH** Power ON/OFF Switch

## **VENT NO. 9**

**THE INNOVATOR REFRIGERATOR VENTILATION SYSTEM (PATENT #5,355,693)**  
For Use with Dometic's RM2852 & RM2862 with Multiple Venting Applications

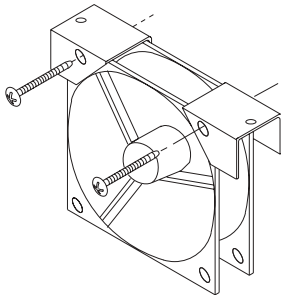

Part No. 3108709.944 **WITH** Power ON/OFF Switch

## **VENT NO. 10**

**DOMETIC (UPPER/LOWER) PLASTIC SIDE VENT**

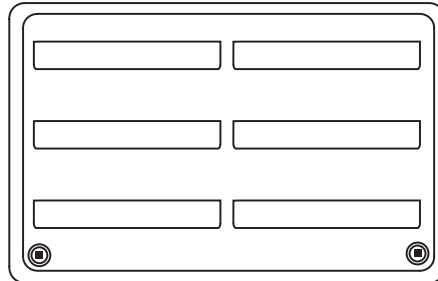

(CUTOUT: 9-11/16" X 19-1/4")

Part No. 3109492.003 Polar White Only

### REFRIGERATOR VENT OPTIONS

(For Description of Option, See Page 3, #4 Methods of Installation)

\* NOTE: Vent Number (listed in "OPTION" column) refers to vent pictures on Pages 12 & 13.

MODEL NO.	VENT DESCRIPTION *	OPTION 1	OPTION 2	OPTION 3-A	OPTION 3-B	OPTION 3-C	OPTION 3-D	OPTION 3-E	
<b>RM2193</b>	ROOF	----		----		----		----	
	UPPER SIDE	----	3	10	3	----		----	
	LOWER SIDE	----	5	10	10	----		----	
	POWER	----				7	7		----
<b>RM2352 RM2353</b>	ROOF	1		1		----		----	
	UPPER SIDE	----	3	3		3	3	10	
	LOWER SIDE	2		2		5	5	10	
	POWER					7	7	7	
<b>RM2410</b>	ROOF	1				----		----	
	UPPER SIDE	----	4	3		3	4	3	
	LOWER SIDE	2		2		2	5	2	
	POWER					7	7	7	
<b>RM2452</b>	ROOF	1				----		----	
	UPPER SIDE	----	4	3		3	4	3	
	LOWER SIDE	2		2		2	2	2	
	POWER					7	7	7	
<b>RM2453</b>	ROOF	1				----		----	
	UPPER SIDE	----	4	3		3	4	3	
	LOWER SIDE	2		2		2	2	2	
	POWER					7	7	7	
<b>RM2510</b>	ROOF	1				----		----	
	UPPER SIDE	----	4	3		3	4	3	
	LOWER SIDE	2		2		2	2	2	
	POWER					7	7	7	
<b>RM2551</b>	ROOF	1				----		----	
	UPPER SIDE	----	4	3		3	4	3	
	LOWER SIDE	2		2		2	2	2	
	POWER					7	7	7	
<b>RM2554</b>	ROOF	1				----		----	
	UPPER SIDE	----	4	3		3	4	3	
	LOWER SIDE	2		2		2	2	2	
	POWER					7	7	7	

**Note:** Numbers listed under vent option, refer to vent numbers on pages 12 & 13.

**Note:** + Order Refrigerators with Power Ventilator installed by Dometic.

**Note:** Option 4 Requires refrigerators to be ordered with pre-installed Innovator Power Ventilator and side vents specified by the corresponding vent option referred to on page 11.

**See Installation Instructions packaged with the Innovator Ventilation System (3108705.751), Patent No. 5,355,693.**

### REFRIGERATOR VENT OPTIONS

(For Description of Option, See Page 3, #4 Methods of Installation)

\* NOTE: Vent Number (listed in "OPTION" column) refers to vent pictures on Pages 12 & 13.

MODEL NO.	VENT * DESCRIPTION	OPTION 1	OPTION 2	OPTION 3-A	OPTION 3-B	OPTION 3-C	OPTION 3-D	OPTION 3-E	
<b>RM2620</b>	ROOF	1	-----	1	-----	-----	-----	-----	
	UPPER SIDE	-----	-----	-----	-----	-----	2	-----	
	LOWER SIDE	2	-----	-----	-----	-----	2	-----	
	POWER	-----	-----	8	-----	-----	+	-----	
<b>RM2652</b> <b>RM2662</b> <b>RM2663</b>	ROOF	1	-----	1	-----	-----	-----	-----	
	UPPER SIDE	-----	-----	-----	-----	-----	2	-----	
	LOWER SIDE	2	-----	-----	-----	-----	2	-----	
	POWER	-----	-----	9	-----	-----	+	-----	
<b>RM2852</b> <b>RM2862</b>	ROOF	1	-----	1	-----	-----	-----	-----	
	UPPER SIDE	-----	-----	-----	-----	-----	2	-----	
	LOWER SIDE	2	-----	-----	-----	-----	2	-----	
	POWER	-----	-----	9	-----	-----	+	-----	
<b>RM2820</b> <b>RM3862</b>	ROOF	1	-----	1	-----	-----	-----	-----	
	UPPER SIDE	-----	-----	-----	-----	-----	2	-----	
	LOWER SIDE	2	-----	-----	-----	-----	2	-----	
	POWER	-----	-----	8	-----	-----	+	-----	
<b>RM4223</b>	ROOF	-----	-----	-----	-----	-----	-----	-----	
	UPPER SIDE	-----	4 — 10	-----	4— 10	-----	-----	-----	
	LOWER SIDE	-----	5 — 10	-----	5— 10	-----	-----	-----	
	POWER	-----	-----	-----	7— 7	-----	-----	-----	
	ROOF	1	-----	1	-----	-----	-----	-----	
	UPPER SIDE	-----	-----	-----	-----	-----	2	-----	
	LOWER SIDE	2	-----	-----	-----	-----	2	-----	
	POWER	-----	-----	8	-----	-----	+	-----	

**Note:** Numbers listed under vent option, refer to vent numbers on pages 12 & 13.

**Note:** +Order Refrigerators with Power Ventilator installed by Dometic.

**Note:** Option 4 Requires refrigerators to be ordered with pre-installed Innovator Power Ventilator and side vents specified by the corresponding vent option referred to on page 11.

**See Installation Instructions packaged with the Innovator Ventilation System (3108709.936), Patent No. 5,355,693.**

### REFRIGERATOR VENT OPTIONS

(For Description of Option, See Page 1, #4 Methods of Installation)

\* **NOTE:** Vent Number (listed in "OPTION" column) refers to vent pictures on Pages 12 & 13.

MODEL NO.	VENT * DESCRIPTION	OPTION 1	OPTION 2	OPTION 3-A	OPTION 3-B	OPTION 3-C	OPTION 3-D	OPTION 3-E
<b>NDR1062</b>	ROOF	1	----	1	----	----	----	----
	UPPER SIDE	----	----	----	----	----	2	----
	LOWER SIDE	2	----	----	----	----	2	----
	POWER	----	----	8	----	----	+	----
<b>NDR1292</b> <b>NDR1402</b> <b>NDR1492</b>	ROOF	1	----	1	----	----	----	----
	UPPER SIDE	----	----	----	----	----	----	6
	LOWER SIDE	6	----	----	----	----	----	6
	POWER	----	----	8	----	----	----	+

**Note:** Numbers listed under vent option, refer to vent numbers on pages 12 & 13.

**Note:** + Order Refrigerators with Power Ventilator installed by Dometic.

**Note:** Option 4 Requires refrigerators to be ordered with pre-installed Innovator Power Ventilator and side vents specified by the corresponding vent option referred to on page 11.

**See Installation Instructions packaged with the Innovator Ventilation System (3108709.936), Patent No. 5,355,693.**