

Plug-n-Tow™ OEM Installation Instructions

⚠ WARNING Installing the Plug-n-Tow system requires basic hand-tool skills. Failure to understand how to install or operate this product could result in property damage and/or personal injury.

REQUIRED PARTS AND TOOLS

- Plug-n-Tow OEM Kit
- Combination Wire stripper-crimper-cutter
- Screw drivers and/or wrenches and/or socket set
- Special tools to access the towed vehicle's taillight assemblies (depends on the vehicle.)

INSTALLATION INSTRUCTIONS

Driver side = Left side Passenger side = Right side

- 1) Find a convenient location to mount the Plug-n-Tow control box that will allow the wiring harness to easily reach the driver side and right tail lights. Out of the way, inside the spare tire well or behind an interior panel.
- 2) Gain access to the back of both the driver side and right taillight assemblies. This may be

accomplished from outside the vehicle or inside the vehicle depending on the make and model.

• **Outside** — remove the screws holding the taillight covers. Remove the covers and work the taillight assemblies loose to expose the wiring.

• **Inside** — remove the plastic or fabric covering the assemblies to expose the wiring.

- 3) Plug the the wiring harness into the controller.
- 4) Route the DRIVER side wiring harness (yellow and brown wires in bundle) to the DRIVER side tail light wiring. Route behind interior panels as practical.
- 5) Route the PASSENGER side wiring harness (green and brown wires in bundle) to the PASSENGER tail light wiring. Route behind interior panels as practical.
- 6) Route the 4-wire FLAT cable to the front of the vehicle. Wire tie every 8 inches to 12 inches as necessary to insure good mechanical connection to vehicle frame.

Refer to the wiring diagram

DRIVER SIDE
Harness and Plugs

PASSENGER SIDE
Harness and Plugs

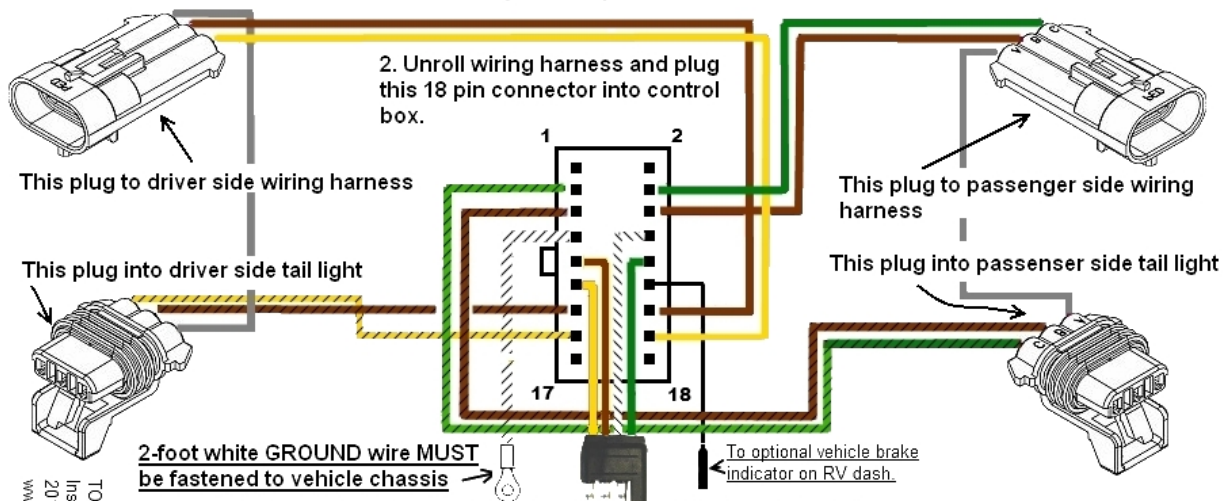

3. Route 4-wire flat cable to tow bar location at the front of vehicle.
4. Use self-taping sheet metal screw to attach this white wire to vehicle ground.
5. Route driver side HARNESS and PLUGS behind interior to driver side tail light access.
6. Unplug vehicle wiring from driver tail light and plug into mating PLUG n TOW connector.
7. Plug remaining PLUG n TOW connector into driver tail light.
8. Route passenger side HARNESS and PLUGS behind interior to passenger side tail light access.
9. Unplug vehicle wiring from passenger tail light and plug into mating PLUG n TOW connector.
10. Plug remaining PLUG n TOW connector into passenger tail light.

TOW DADDY PLUG n TOW
Installation Instructions
201012151 rev 0
www.towdaddy.com

DRIVER SIDE Wiring

- 1) Unplug tail light from vehicle wiring.
- 2) Insert Plug-n-Tow connector into mating tail light connector.
- 3) Plug vehicle wiring connector into remaining Plug-n-Tow connector.
- 4) Neatly bundle harness wire slack and zip-tie.
- 5) Carefully re-install the tail light assembly taking care not to pinch wires or crimps.
- 6) Re-install any interior panels that were removed for routing the harness to the driver side.

PASSENGER SIDE Wiring

- 1) Unplug tail light from vehicle wiring.
- 2) Insert Plug-n-Tow connector into mating tail light connector.
- 3) Plug vehicle wiring connector into remaining Plug-n-Tow connector.
- 4) Neatly bundle harness wire slack and zip-tie.
- 5) Carefully re-install the tail light assembly taking care not to pinch wires or crimps.
- 6) Re-install any interior panels that were removed for routing the harness to the driver side.

- 1) Mount controller in an out of the way location. Peel protective cover off the sticky foam on the back of the controller and firmly press it in place.

 *The white wire with ring lug must be attached to vehicle metal chassis otherwise the Plug-n-Tow controller will not operate correctly*

- 2) Route the 2-foot WHITE wire to a metal chassis location. Drill a ¼ inch hole if necessary to route wire to outside the vehicle. Strip ¼ inch insulation from wire end and crimp on the ring terminal provided in the kit. Use the self-tapping screw to attach the ring terminal to chassis ground.

PLUG-n-TOW Test and Operation Guide

 **CAUTION** While towing a vehicle equipped with a remote brake system, it will be necessary to turn on the RV tail lights to provide power to the braking system.

 *Have another person assist you when checking the tow system lighting for proper operation.*

TEST BEFORE TOWING

- 1) When you have your towed vehicle hitched and ready to tow, make sure the towed vehicle electrical (umbilical) cable is connected between your towed vehicle and RV.
- 2) Have your assistant sit at the driver seat in the RV.
- 3) While standing at the rear of the towed vehicle, have your assistant switch on the RV running lights.
- 4) Both the RV tail lights and the towed vehicle tail lights will light.
- 5) Have your assistant press the brake pedal in the RV. RV brake lights and towed vehicle brake lights will brightly light.

 *On towed vehicles with **SEPARATE BRAKE AND TURN** lights, the **PLUG n TOW** controller will light **both BRAKE and TURN lights together**. **THIS IS AN ENHANCED FEATURE** that gives your towed vehicle higher visibility to those driving behind you.*

- 6) Have your assistant release the brake pedal.

- 7) Have your assistant turn on the driver side turn signal. The driver side turn light on the RV will blink along with the driver side brake light (and separate driver side turn light) on the towed vehicle.
- 8) Have your assistant turn on the right turn signal. The right turn light on the RV will blink along with the right brake light (and separate right turn light) on the towed vehicle.

AFTER THE TOW

- 1) After unhitching and disconnecting the towed vehicle, verify brake and turn signal lights are working properly before driving.

 *The umbilical cord, used to connect brake and turn signals between the motor home and the towed vehicle, is not included in this kit.*

 *The plug, socket and mounting bracket for the towed vehicle are not included in this kit.*

 *The towed vehicle remote brake indicator wiring and components are not included in this kit.*