



RV



Before operating the awning, carefully review the Owner's Manual. The manual contains important safety information, detailed operating instructions, common maintenance procedures and other useful information.



The Awning Extend'r doubles the shade area of your awning and can be used with any awning that has an accessory slot in the roller tube or lead rail.

TABLE OF CONTENTS

Introduction	2
Setup	3
Installing on a Vertical Arm Awning	3
Manual Awnings - Start Here.....	3
Motorized Awnings - Start Here.....	3
Installing on a Box Awning	4
Setting the Poles	4
Storage	6
Awning Care	7
Fabric Care.....	7
Mildew	7
Pooling	7
Leaking.....	7
Support Care	7
Carefree Major Product Limited Warranty.....	8

INTRODUCTION

From its beginning in the early 70's, Carefree of Colorado has emerged as the premier manufacturer of quality awnings and accessories for Recreational Vehicles (RVs). Our full line of products can provide the accessories that match your life style; no matter what type of RV you own.

⚠ WARNING Awnings are designed to provide shade and protection from the sun. The effects of wind and rain on an awning are unpredictable and can cause severe damage to the awning and/or the vehicle. If wind or extended periods of rain are expected, roll up the awning.

NOTICE It is recommended that if leaving the RV unattended for a length of time, retract the awning to avoid unexpected climate conditions.

NOTICE Set the awning power switch to off to prevent the awning from retracting when the supports are installed. Retracting the awning with the supports and tie-downs attached can damage the awning.

NOTICE Always remove the supports before retracting the awning. Retracting the awning with the tie-downs attached can damage the awning.

⚠ WARNING Keep all sources of heat and flame away from the canopy. Fabric is not fire-proof and can burn if left in contact with any flame or heat source.

CALIFORNIA PROPOSITION 65

⚠ WARNING This product contains chemicals known to the state of California to cause cancer or birth defects or other reproductive harm. California's Proposition 65 requires this warning to be given to customers in the state of California.

Kit Contents

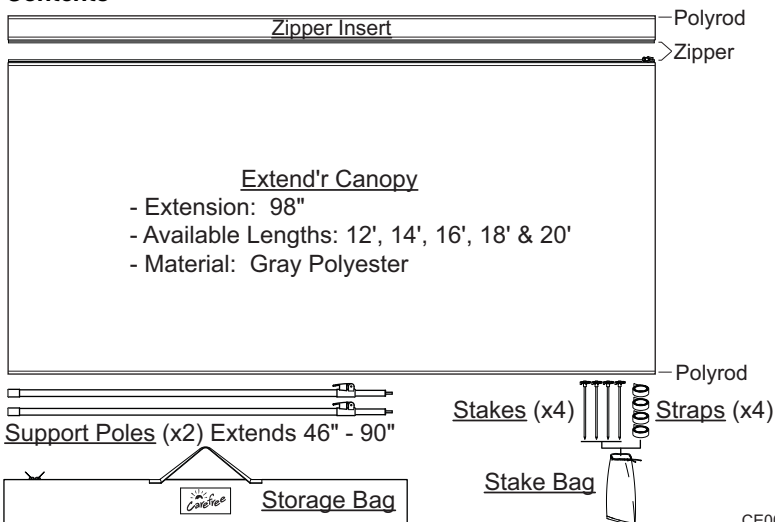

CE006

SETUP

INSTALLING ON A VERTICAL ARM AWNING

MANUAL AWNINGS - START HERE

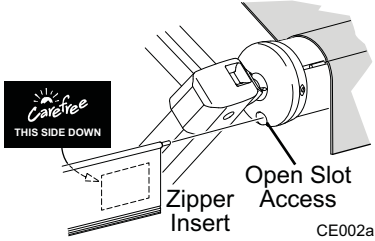
1. Extend the awning out according to the manufacturer's instructions. Ensure that the open roller tube slot and slot access is down and accessible on the idler (LH) side of the awning.
 2. If necessary, clean and deburr the slot and slot access.
 3. *For awnings with a pull strap*, slide the pull strap down to the opposite end of the roller tube.
 4. Unfold the canopy extension and remove the zipper insert from the top.
- 
- CE002a
5. Slide the polyrod edge of the insert into the open slot of the roller tube. Orient the insert with the seams toward the vehicle.
 6. If the awning was over extended to access the slot, retract the awning to tension the awning canopy as described in the awning instructions.
 7. Center the insert then zip the Extend'r canopy to the insert.

MOTORIZED AWNINGS - START HERE

1. Extend the awning out according to the manufacturer's instructions.

For awnings without Auto Retract:

- Hold the EXTEND switch until the empty slot of the tube aligns with the slot on the back of the idler (LH) head.

For awnings with Auto Retract:

- After extending the awning, press and release the retract button. Stop the awning when the roller tube makes approximately 1/2 turn.
- Hold the EXTEND switch until the empty slot of the tube aligns with the slot on the back of the idler (LH) head.

2. Unfold the Awning Extend'r and remove the zipper insert from the top.

Over Extend (Reverse Wrap)
Canopy on Tube.
(View Looking at Back of Idler Head)

Tip: Clean the slot and lightly spray the inside with a dry silicone lubricant. This will aid with sliding the canopy in.

3. Slide the zipper insert into the open slot of the roller tube.
4. Using the retract switch, retract the awning to tension the awning canopy as described in the awning instructions.
5. Center the insert then zip the Extend'r canopy to the insert.

INSTALLING ON A BOX AWNING

Campout

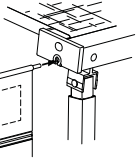

Freedom WM

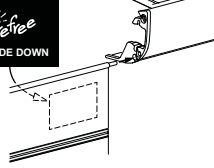

Freedom RM

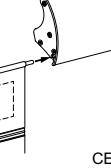

CE001a

1. Extend the awning out according to the manufacturer's instructions. If the awning has vertical support legs, set the legs in the vertical (carport) position.

NOTE: For the Freedom Wall Mount, leave one leg stored until the canopy is installed. This is to allow access to the slot in the lead rail.

Tip: Clean the slot in the lead rail and lightly spray the inside with a dry silicone lubricant. This will aid with sliding the canopy in.

2. Slide the Awning Extend'r into the slot of the lead rail with the "This Side Down" label toward the vehicle.

SETTING THE POLES

This procedure is easiest done with two people.

1. Set the awning to the desired pitch.
2. Stretch the canopy extension out from the awning.
3. Place the post of the vertical support through the ring in the corner of the extension.
4. Open the height adjustment lever on the vertical support and adjust the height of the support as desired.

The poles may be adjusted from 46" to 90".

5. With a second person holding the support, place a stake through the d-ring of the tension strap. Then drive the stake into the ground approximately 5'-6' in front of the fabric.
6. Place the top d-ring over the vertical support post. Tighten the strap by pulling the open end of the strap through the tension adjustment rings.
7. Place a second stake through the d-ring of the second tension strap. Then drive the stake into the ground approximately 5'-6' to the side of the vertical support and in line with the front edge of the canopy extension.
8. Place the top d-ring over the vertical support post. Tighten the strap by pulling the open end of the strap through the tension adjustment rings.

NOTE: You may need to adjust the strap tension after attaching the other side.

To loosen the straps, lower the height of the vertical support until the strap sags. Loosen the strap through the tension adjustment rings.

9. Repeat for the other side.

NOTICE

If it is necessary to adjust the awning pitch after staking down the canopy extension; loosen the tension straps before adjusting the pitch. Failure to do so may cause damage to the awning and canopy extension.

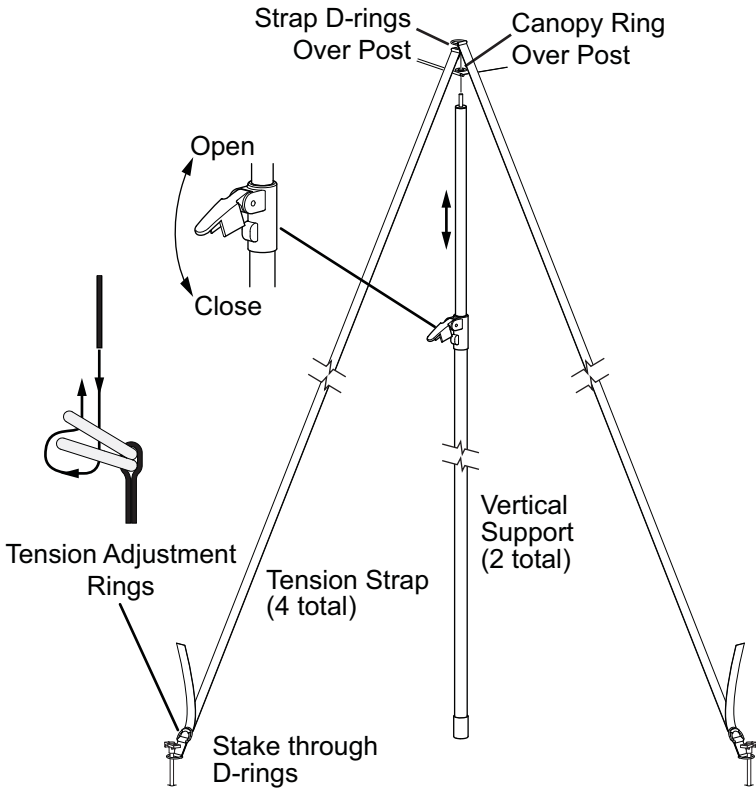
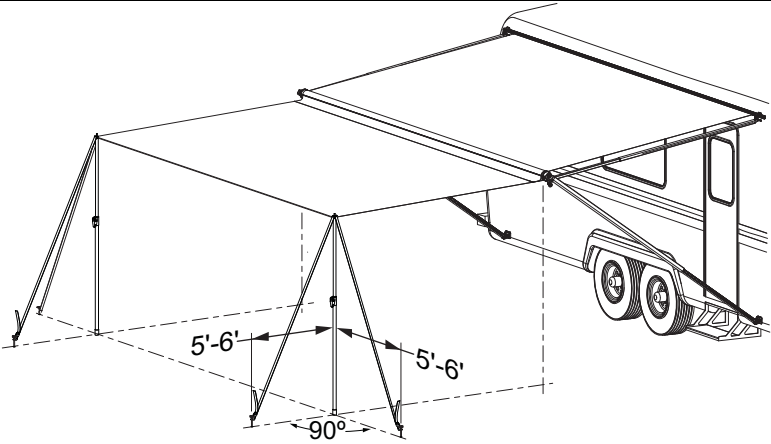

CE004a

STORAGE

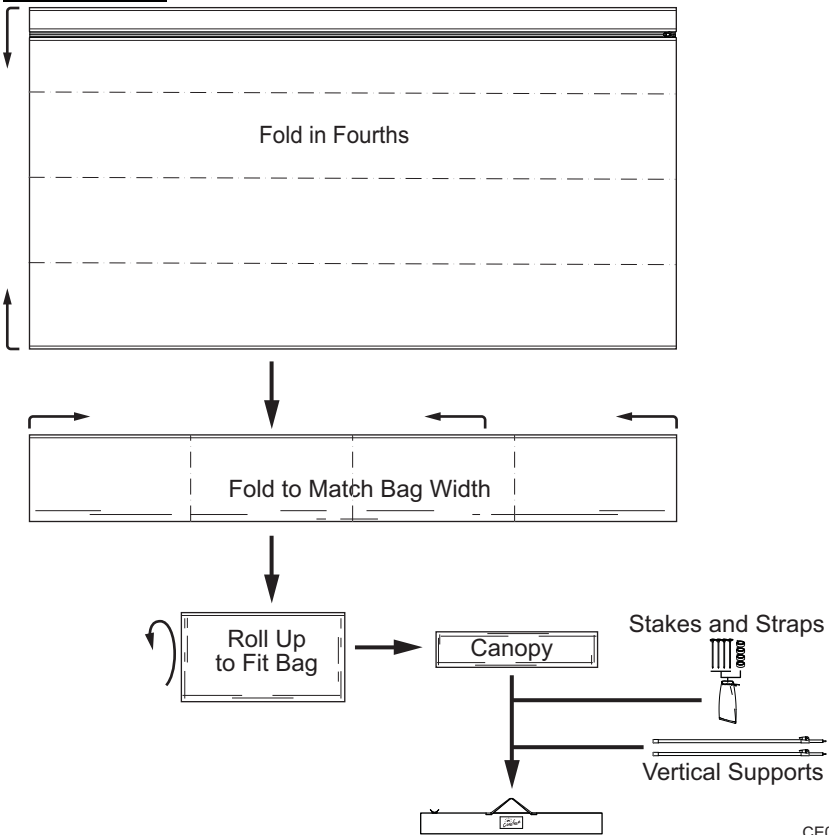

CE005

1. Shorten the vertical supports to release the tension on the straps.
2. Remove the stakes and straps and store in the parts bag.
3. Remove the Extend'r from the roller tube.
 - 3.1. *For manual awnings with vertical arms and box awnings:* Slide the canopy and zipper insert from the roller tube.
 - 3.2. *For motorized awnings with vertical arms:* Unzip the canopy. The zipper insert can be left in the roller tube and rolled up with the awning.
4. Fold the canopy as shown above.
5. Store the canopy, vertical supports and parts in the carry bag.

AWNING CARE

Maintaining a Carefree product is easy. Just follow these basic steps:

- Always setup the canopy extension according to the instructions.
- Periodically check that the fasteners are tight. Tighten if necessary.
- Keep the awning fabric and arms clean.

FABRIC CARE

NOTICE Do not use oil based cleaners or any caustic, granulated, or abrasive type cleaners on your Carefree product.

1. One of the best ways to keep the fabric looking good and to delay the need for deep or vigorous cleanings is to hose fabrics off on a monthly basis with clear water. This practice will help prevent dirt from becoming deeply imbedded in the fabric. In most environments, a thorough cleaning will be needed every two to three years.
2. When it is time for a thorough cleaning, the fabric can be cleaned while still on the awning frame. For vinyl fabric, use a soft brush and warm water with soap.
3. When cleaning the fabric, it is important to observe the following:
 - Always use a natural soap, never detergent.
 - Water should be cold to lukewarm, never more than 100°F.
 - Air-dry only. Never apply heat to the fabric.
 - Always allow the fabric to dry thoroughly before rolling up for storage.

MILDEW

Mildew is a fungus growth that looks like dirt. Vinyl coated polyester fabrics are mildew resistant because of a chemical biocide in the vinyl coating. Under ordinary conditions, mildew will not appear. However, in areas where high temperature and humidity are common, mildew can be a problem and require the material to be washed more frequently. Thoroughly rinse the fabric with clean water and allow to air dry completely before storing the canopy.

POOLING

When water collects on the top of the fabric, this is known as "pooling". This can occur during inclement weather or if a running air conditioner discharges over the awning. The water is dumped when the awning is retracted. It is recommended that if water accumulates on the top; lower the canopy in steps (8"-12") to dump the water. This will help prevent the fabric from stretching or distorting.

LEAKING

On vinyl canopies, side hems and poly cords are stitched in with a sewing machine. On occasion, this stitching may allow water to seep or leak through the stitches. This is normal and not a defect covered by warranty. Treat the seams with a quality seam sealer.

SUPPORT CARE

The best method of keeping the supports operating smoothly is to clean them. Dirt and debris can cause the channels not to slide easily.

Periodically wash out the channels with running water (i.e. a hose) to keep them clean. If the channels still do not slide easily, lightly spray the inside of the channels with a dry silicone lubricant, after the arms have been cleaned and dried thoroughly.

CAREFREE MAJOR PRODUCT LIMITED WARRANTY

Carefree of Colorado (hereafter referred to as Carefree) warrants to the first retail Purchaser that the Carefree Product is free of defects in material and workmanship within the terms and conditions as set forth in the warranty statement available online at www.carefreeofcolorado.com. Carefree's obligation under this warranty is limited to the repair or replacement, at Carefree's option, of any defective component with new or factory refurbished components.

OWNER MUST RETAIN THE ORIGINAL PROOF OF PURCHASE AND/OR HAVE THE PRODUCT WARRANTY REGISTRATION ON FILE AT CAREFREE FOR WARRANTY CLAIMS.

THIS WARRANTY IS NOT TRANSFERABLE.

For

- **Warranty Duration;**
- **Warranty Coverage and Exclusions;**
- **Warranty Terms of Coverage; and,**
- **Warranty Claim Procedures**

Refer to publication
"Carefree Major Product Limited Warranty"
available online at
www.carefreeofcolorado.com

Register your Carefree products on-line at www.carefreeofcolorado.com

