



BX1981

2008-12 Dodge Dakota Installation Instructions

Serial Number

Please read BOTH these Installation Instructions and the General Instructions before attempting to install or operate this equipment.

- Blue Ox® towing products and accessories are intended to be installed by Blue Ox® Dealers who are familiar with our products and have the equipment necessary and knowledge to do “fit work”. When necessary Blue Ox® Dealers can be found at www.blueox.com or by contacting our Customer Care Department at (402) 385-3051.
- Many Blue Ox® Baseplates are designed to use existing holes and hardware to mount the baseplate to the towed vehicle. Even though bolts are there, do not assume they are adequate for baseplate mounting. Always use hardware supplied in the hardware kit and existing hardware specified in the Baseplate Installation Instructions.

Attachment Tab Height: 16-1/2”
Attachment Tab Width: 23-3/8”

Bolt Torque Specifications
Torque in Foot-Pounds for Metric Bolts

Bolt Size	Grade 8.8	Grade 10.9
6MM	6	8
8MM	16	22
10MM	31	40
12MM	54	70
14MM	89	117

Confirm the towability and pre-towing procedures for your vehicle with the owner’s manual or contact the vehicle’s manufacturer for specific towing procedures.

Do not use the towed vehicle for storing luggage, equipment, etc. This may cause you to exceed the towing capacity of the tow bar, baseplate, and its accessories.

Bolt Torque Specifications
Torque in Foot-Pounds for Inch Bolts

Bolt Size	Grade 5	Grade 8
1/4”	10	14
5/16”	19	29
3/8”	33	47
7/16”	54	78
1/2”	78	119
5/8”	154	230



If the front of your vehicle looks different than this, call us at (402) 385-3051.

! WARNING

Failure to read and follow these instructions could result in separation of the towed vehicle from the tow bar, causing property damage, loss of towed vehicle, personal injury or death.

BX1981

2008-12 Dodge Dakota

Installation Instructions

Parts List

Ref. No.	Qty.	Part #	Description
1	1	61-6500	WLDM'T, BASEPLATE, BX1981
2	8	61-4604	WLDM'T, 1/2 NUT PLATE WITH 10" WIRE
3	8	201-0051	1/2-13 X 1 1/2 HEX BOLT GRADE 5, ZP
4	8	203-0012	1/2 LOCK WASHER, ZP
5	2	201-0553	1/4-20 X 1/2 HX.WSHD.TYPE F TCS, ZP
6	2	201-0192	10-32 X 1/2 SLOT, RD. HD. SCREW
7	2	203-0054	#10 LOCK WASHER
8	2	202-0047	#10-32 HEX NUT
9	2	101-5822	ADAPTER, 4 WAY CONNECTOR
10	2	62-3469	ATT TAB ASSY, REM, SF/LB, 1 HOLE
	2	226-0046	BASEPLATE SAFETY CABLE, 36" CL III (NS)
	2	229-0359	QUICKLINK, 3/8, ZP (Not Shown)
	2	290-0437	RECEIVER, CAP PLUG (BLK) (Not Shown)

Tools Required

10MM Socket
 18MM Socket
 3/4" Socket
 17/32" Drill Bit
 30 Torx
 Large Vise Grips
 Loctite® Red
 Phillips Screwdriver
 Reciprocating Saw
 Utility Knife

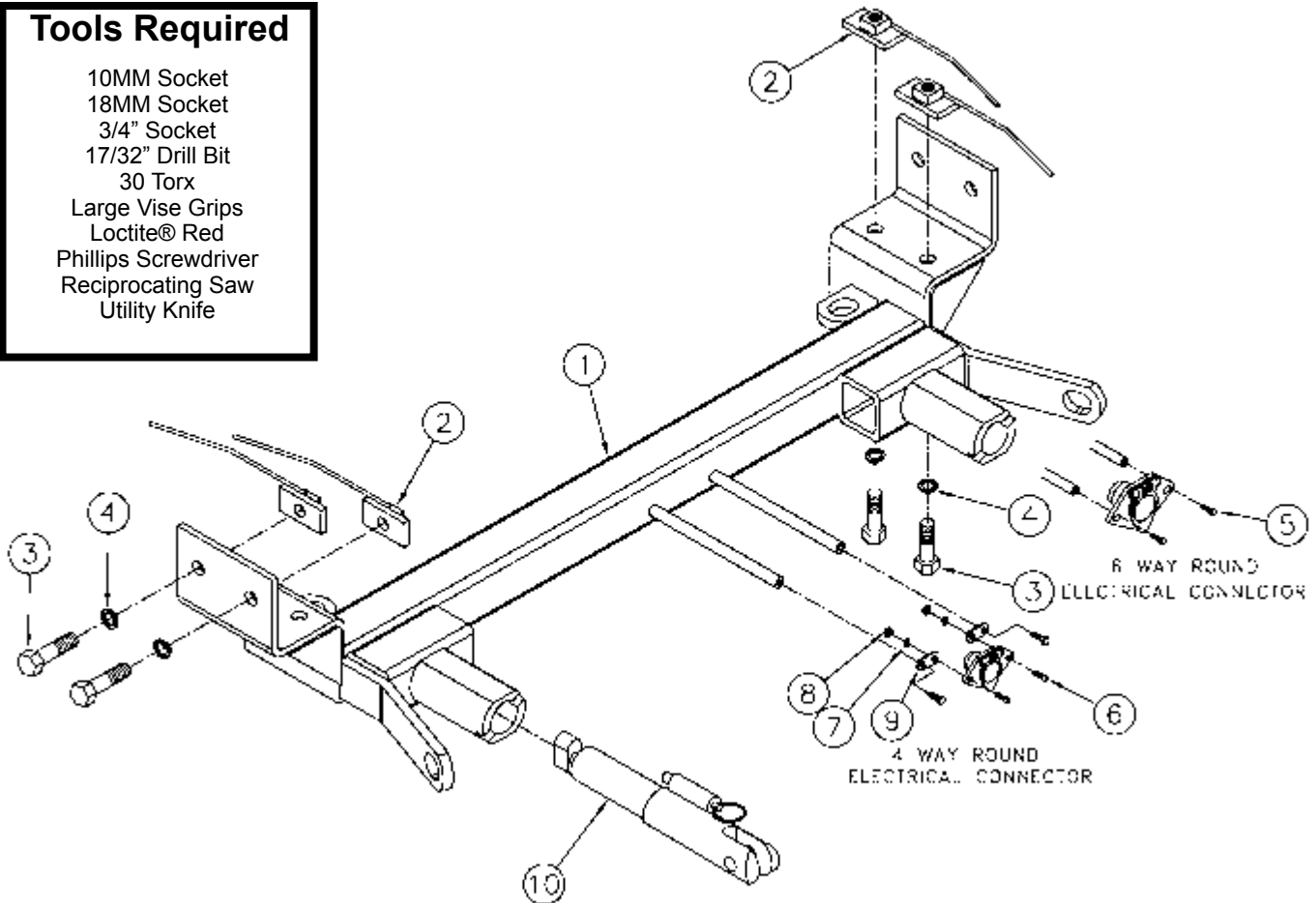

Important:

Use only genuine factory replacement parts on your baseplate. Do NOT substitute homemade or non-typical parts. If a bolt is lost or in need of replacement, for your safety and the preservation of your baseplate, be sure to use a replacement bolt of the same grade (In most cases it will be Grade 5, please reference the parts list above). Replacement parts may be ordered through your nearest Blue Ox® Dealer or Distributor, or call our Customer Care Team at (402)385-3051. Failing to follow and/or altering these installation instructions in either installation or required equipment will void the manufacturer's warranty.

BX1981
2008-12 Dodge Dakota
Installation Instructions

Removable Tab: Due to the design of the removable tabs, the RangeFinder II and Ambassador tow bars can not be used. Adapters, except the BX8833 and the BX88151, can not be used with this baseplate.

Installation Notes: The fascia, front bumper, bolts and push pins are removed and reinstalled for the baseplate installation. Drilling is required. Trimming is required.

The dimensional variations between otherwise identical vehicles can be considerable. While the baseplate was designed for easy installation, it may be necessary to tailor the baseplate slightly to compensate for auto manufacturer's tolerances. These minor adjustments may include filing a hole slightly, bending electrical rods or bending end plates.

The BX8848, 4-Diode wiring kit is recommended for this vehicle.

Installation Instructions:



1. Using the 10MM socket, remove two metric bolts from the edge of the wheel well, just forward of the front tire. Do this to both sides of the vehicle. Set the metric bolts aside to be reinstalled later.

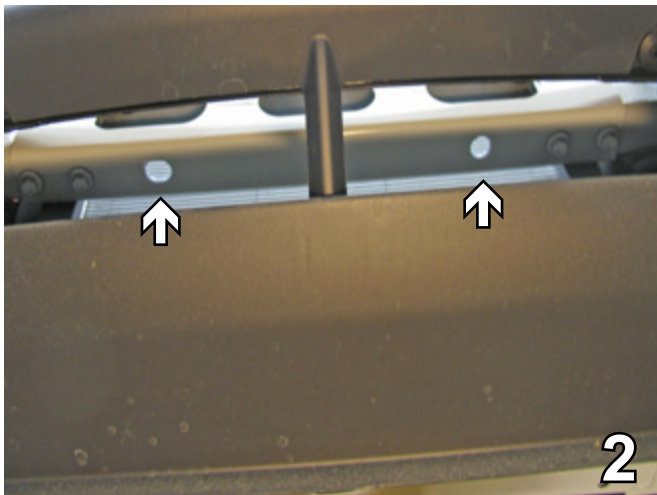

2. Remove the two Phillips pushpins from the lower edge of the fascia just below the license plate. Pull fascia corner out to the side of vehicle, both sides, then pull fascia forward and set fascia and the pushpins aside carefully to be reinstalled later.



3. On the 2009, using a 30 Torx remove three screws located on the top part of the bumper. Set the screws aside to be reinstalled later.

Handling of some cosmetic parts when installing this product may require the use of protective covers, rags, specialty tools, etc. to prevent damage.

BX1981
2008-12 Dodge Dakota
Installation Instructions

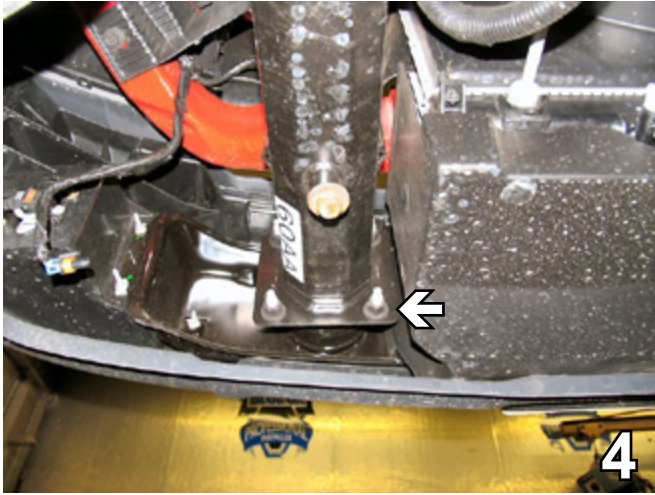

4. Using the 18MM socket, remove four metric nuts. Located just behind the metal bumper, on the frame end. Do this to both sides of the vehicle. Pull the metal bumper forward, unplug the electrical connections and set the metal bumper and nuts aside to be reinstalled later.

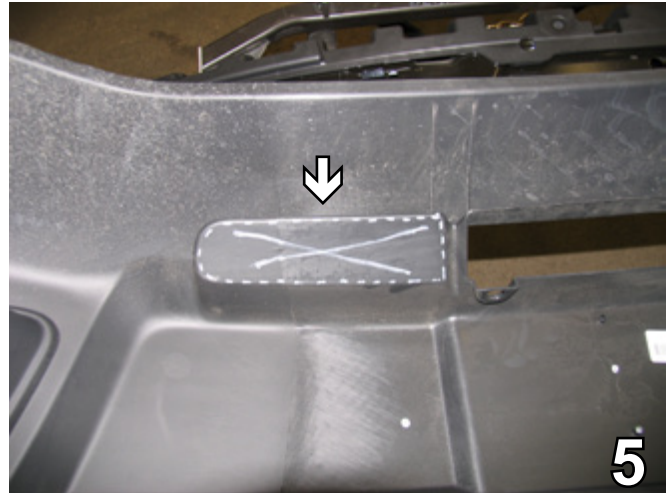

5. 2008-09 vehicles without tow hooks will need to measure and mark a horizontal line in the plastic, as indicated in the photo above, and cut out the area with a utility knife. Do this to both sides of the vehicle. This will allow the baseplate to slide onto the frame rail.



6. Slide the baseplate onto the frame rail to align forward side hole with existing hole in the 2008-09 frame and clamp in place with the vise grips. Do this to both sides of the vehicle. Insert the nutplate into the end of the frame rail to align with the existing hole, tighten the 1/2-13 x 1 1/2" hex bolt and lock washer with the 3/4" socket. Use Loctite Red on all bolts. Do this to both sides of the vehicle.

Note: Some models, including the 2010, may not have existing holes in the frame, slide the baseplate up and forward as far as possible.

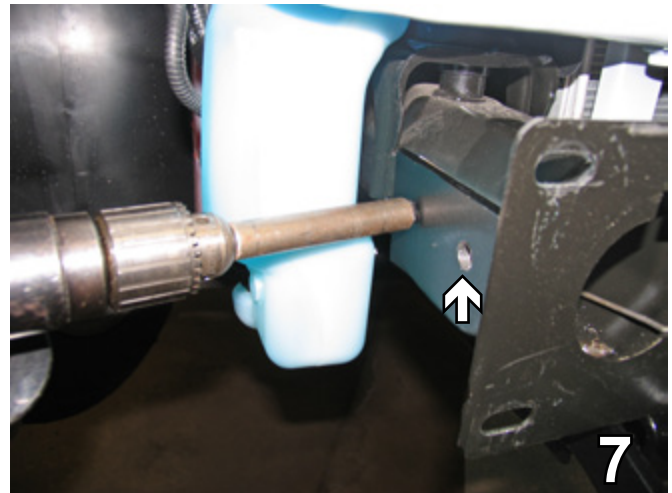

7. Using the baseplate as a template, drill the remaining three holes with the 17/32" drill bit. Do this to both sides of the vehicle. It may be necessary to slide a piece of tubing over the drill bit to protect the reservoir tank.

When using power drills be aware of the dangers of torque and drill bit length.

Be sure to use Loctite® Red on all bolts before tightening. Tighten all bolts according to the torque chart on the front page of these instructions or on page 3 of the baseplate towing general instructions.

BX1981
2008-12 Dodge Dakota
Installation Instructions

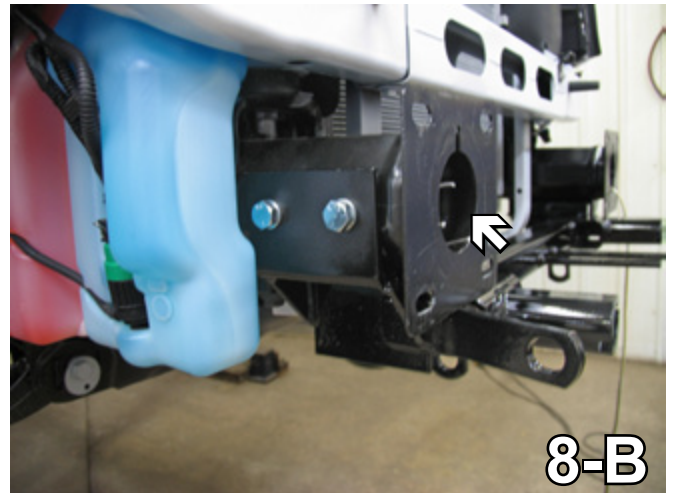
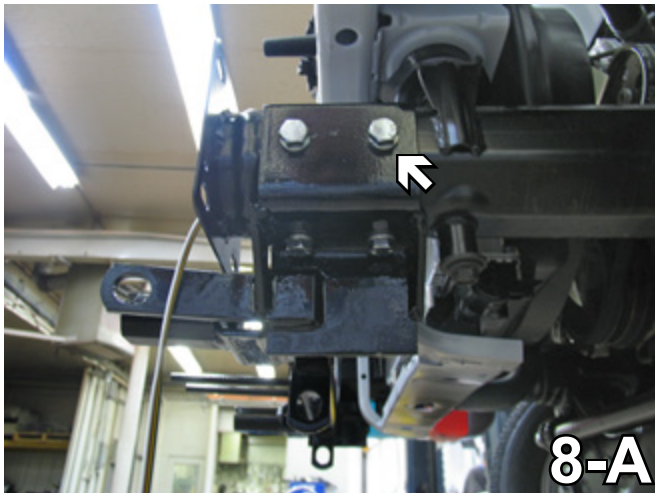

8. Insert the nut plates into the frame rail to align with the drilled holes (8-A), tighten the 1/2-13 x 1 1/2" hex bolts and the lock washer with the 3/4" socket into the nutplates (8-B). Do this to both sides of the vehicle.



9. Using a reciprocating saw, trim the lip straight down from the center of the hole over 5", to get the bumper back on. Do this on both sides.

10. On the 2009, trim the shroud on the lower part of the radiator. Do this on both sides.

11. Reinstall the metal bumper. **Be sure that all electrical connections are plugged in properly.**

Note: Some models may not need to have material removed from the bumper. Slide the bumper into place to verify the proper fit.

12. Attach baseplate safety cables. Position the cables around a solid piece of the frame. Be sure the safety cables do not rub against any hoses or moving parts.

13. Reinstall the fascia.

Be sure that ALL electrical connections are plugged in properly and functioning BEFORE installing the fascia.



Possible location for the electrical bracket

BX1981
2008-12 Dodge Dakota
Installation Instructions

Install the tow bar and safety cables according to the instructions included in their packages.

Do not substitute other devices if the tow bar pin and clip are lost.

DEALER OR INSTALLER: BE CERTAIN THE USER RECEIVES THE INSTRUCTION SHEETS.



2008 - Shown with removable tabs installed



2009 - Shown with removable tabs installed



2010 - Shown with removable tabs installed

CUSTOMER SERVICE COMMITMENT

Blue Ox is committed to providing you with exceptional customer care throughout your lifetime with our products. Our team is here to assist you with any questions you may have regarding the performance of your product. Simply call (402) 385-3051 and you can speak with our customer care team.

Additionally, please visit our website to see which rallies our Destination America team will be attending. For a nominal fee, our service technician will service your towing system to ensure it's in proper working condition. Also, as a commitment to our customers, should you visit our factory, you can stay at our full service Blue Ox campground at no charge along with enjoying a factory tour.

Again, thank you for being our customer and for the confidence you have shown in the performance of our products. It is because of customers like you we enjoy the success we have today.

If the baseplate is in an accident, it must be replaced. DO NOT use it again! An accident can cause unseen damage and using it again could result in more damage or serious injury. DO NOT use the baseplate if it is damaged or missing parts.



© 2011 Blue Ox
One Mill Road, Industrial Park
Pender, Nebraska 68047
Phone: (402) 385-3051
Toll Free: (888) 425-5382
Fax: (402) 385-3360
www.blueox.com