



TRAILER TONGUE MOUNTED TRAILER TRAY

MODEL # CC-255

Thank you for purchasing the first trailer tongue cargo carrying system by Stromberg Carlson Products, Inc.

Please read all directions prior to installation. The Trailer Tray may not work on all trailers. Confirm fit and clearance prior to drilling any holes (approximately a 1 hour installation, depending on the number of items needing to be removed and reinstalled to accommodate this device). Installation should be a two person project, due to the sturdy construction and weight of the tray itself.

Check trailer frame area where frame pockets are to be mounted for items that may interfere with installing the frame pockets, such as wiring, battery, battery tray, equalizer brackets, etc. Most of the items can be relocated or reinstalled after the frame pocket brackets have been installed, as they do not take up very much space.

If you have propane tanks installed at the intended tray location, one of three things can be done to allow you to remove your tanks for refill or to access valves without removing the tray.

- You can replace your existing tank cover with a soft vinyl cover which will allow you to access your LP tank valves or remove LP tanks without having to remove the tray.
- You can replace your existing tank cover with a hard plastic cover with a flip top to access your LP tank valves. You will still need to remove the tray to remove cover and refill LP tanks.
- Leave the tank cover off for direct access to your LP tanks.

Mount lower pockets (figure F) and lower mount back plates (figure G) on trailer frame using enclosed bolts and nuts (figure K), ensuring back edge of pockets are approximately 2"-3" from trailer body. Be sure to mount pockets on the outside of trailer frame and washers on inside of trailer frame, as shown on page 2. Supplied bolts can be installed in either direction to prevent interference with other items on the mount area (be sure to connect hardware loosely to allow for minor adjustments to The Trailer Tray later in the installation). Secure using mount holes that fit most close-fitting to your specific trailer frame top and bottom edge (pockets and washers have numerous mounting holes to accommodate various trailer frame sizes).

Attach the trailer tray plates (figure I) to the sides of the trailer tray (figure A) as shown on page 2, using the enclosed hardware (figure M). Attach the upper pockets (figure E) to the trailer tray plates, using enclosed hardware (figure L). Install either end of the vertical tubes (figure B) into frame pockets, as shown on page 2. Rotate vertical tubes to allow the upper pockets to slide onto them, having a 2nd person stabilizing the tray. Move the tray to the position you like, preferably 1"-2" away from the trailer front wall. Secure vertical tubes at bottom and tray assembly at top using provided bolts and set screws (figures N and O), as shown on page 2. Holes measuring $\frac{5}{16}$ "- $\frac{3}{8}$ " will need to be drilled through the vertical tubes to accommodate this hardware, once you verify turn radius clearance. For safety and accuracy purposes, you may want to mark hole locations, dismantle trailer tray and then drill holes (drill through each tube halfway only, then from the other side halfway to ensure tube holes align properly with pocket holes) then reassemble. Tighten nuts, double checking that the trailer tray is still approximately 1"-2" from the front trailer wall.





Connect lower mount (figure H) to the lower support mount (figure D) using the 2 holes nearest the outside of your A-frame, using enclosed hardware (figure J). Attach loosely, to allow for adjustment. Connect upper support mount (figure C) and lower support mount (figure D) together using enclosed hardware (figure L). Attach upper support mount to trailer tray (figure A) using enclosed hardware (figure L), adjusting location of the lower mount to allow for proper attachment. Tighten all hardware.

Please note, the tray has several tie down eyelets on the edges and numerous holes in the tray top to secure your cargo.

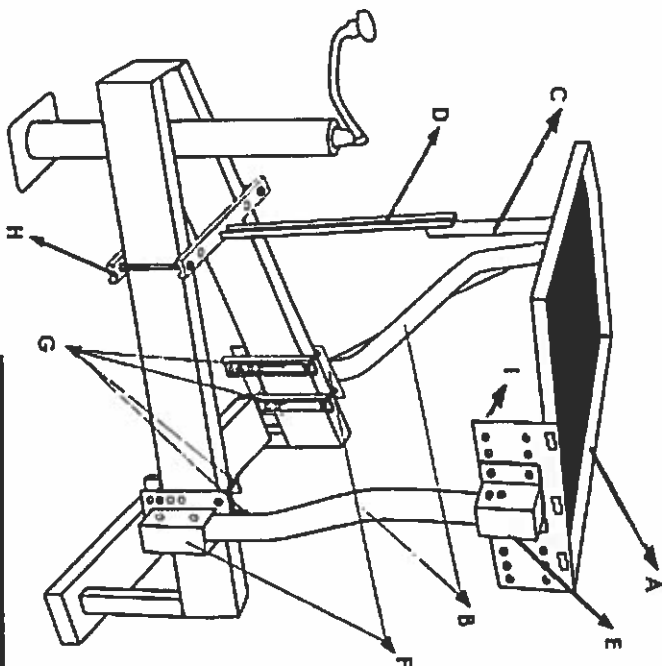
CARTON CONTENTS

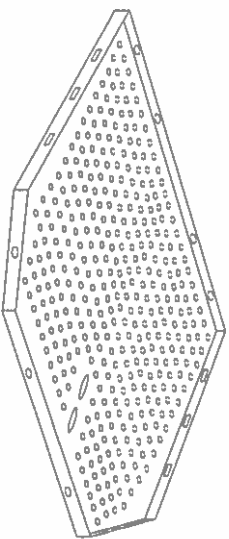
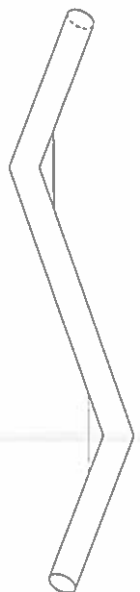
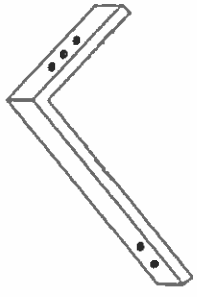
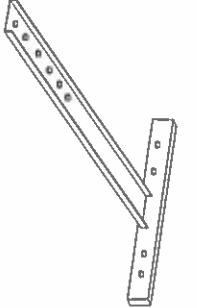
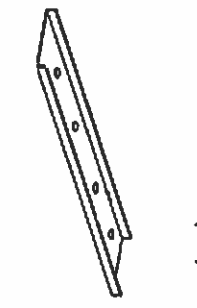
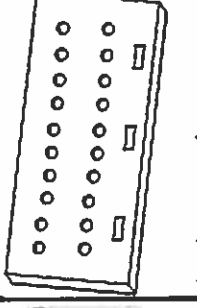
TRAILER TRAY CC-255

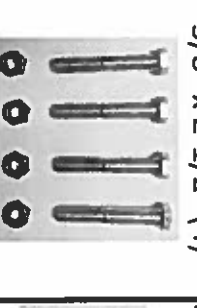
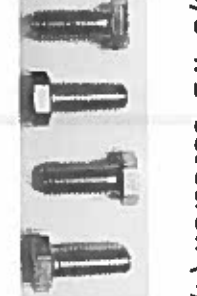

<p>Trailer Tray (x1)</p>  <p>Figure A</p>	<p>Vertical Tube (x2)</p>  <p>Figure B</p>
<p>Upper Support Mount (x1)</p>  <p>Figure C</p>	<p>Upper Pocket (x2)</p>  <p>Figure D</p>
<p>Lower Support Mount (x1)</p>  <p>Figure E</p>	<p>Lower Pocket (x2)</p>  <p>Figure F</p>
<p>Lower Mount Back Plate (x4)</p>  <p>Figure G</p>	<p>Trailer Tray Plate (x2)</p>  <p>Figure H</p>
<p>Lower Mount (x1)</p>  <p>Figure I</p>	<p>5/16" x 8" (2)</p>  <p>Figure J</p>
<p>5/16" x 4" (8)</p> <p>Figure K</p>	<p>5/16" x 1" (12)</p> <p>Figure L</p>
<p>3/8" x 3/4" (6)</p> <p>Figure M</p>	<p>3/8" x 2-1/2" (4)</p> <p>Figure N</p>
<p>3/8" x 1" Set Screw (4)</p> <p>Figure O</p>	