



---

---

## KOP4800 Installation Guide

This guide contains installation and safety information  
for your KING One Pro.

Please read thru this guide before using or installing  
your KING One Pro.



**QUESTIONS? (952) 345-8147**



## IMPORTANT SAFETY INFORMATION

1. Please read this safety information thoroughly before using or installing the KING One Pro.
2. Keep this safety information and the included Quick Reference Guide in a safe place for future reference.
3. Follow all instructions and warnings. Set up, operate and install (optional) the KING One Pro in accordance with the instructions.
4. Do not submerge the KING One Pro or place in standing water. Hand wash only with mild soap and water.
5. Do not operate or store near any indoor or outdoor heat source such as radiators, heat registers, stoves, barbecues, campfires, or other items that produce heat.
6. Servicing may be required if the unit has been dropped or damaged in any way or if the unit does not operate normally. Call KING Customer Service at (952) 345-8147.
7. Tighten all of the coax cable connections only by hand. If you use a wrench, you may over-tighten the connections and damage your equipment.
8. To avoid risk of electrical shock, unplug your receiver before connecting/disconnecting the KING One Pro in damp or wet conditions.
9. Always handle the KING One Pro carefully. Do not drop the KING One Pro. Avoid excessive shock or vibration to the KING One Pro.
10. Use caution when carrying the KING One Pro. Always carry the KING One Pro by the handle.
11. Do not remove the cover of the KING One Pro without authorization. Doing so will void the limited warranty.
12. Do not stack the KING One Pro on top of or below other electronic devices as this can cause heat build-up or block the satellite signal from reaching the KING One Pro.
13. Keep the enclosure clean from dirt, bugs, and other debris by hand washing with mild soap and water.
14. Do not coat or paint the KING One Pro with any substance.
15. The KING One Pro has been designed to be maintenance and trouble free. If not using the KING One Pro for long periods of time, it is recommended that you set up the system on a quarterly basis (every three months) to keep all moving parts of the KING One Pro in good working order.
16. The KING One Pro can be secured to an object by looping a cable (sold separately) thru the handle and attaching the cable to a secure object.



**DO NOT OVER-TIGHTEN COAX CONNECTIONS.**



**DO NOT POWER WASH THE ANTENNA UNIT.**

If you have any comments or questions, please contact KING Customer Service at (952) 345-8147, or by email at [help@kingconnect.com](mailto:help@kingconnect.com).

## OPTIONAL MOUNTING ACCESSORIES

Although the antenna unit is designed to be mounted directly to the roof, the following two options are also available.

### MB160

Mounting Bracket



The KING One Pro is not compatible with the MB100 Mounting Bracket. Use of MB100 will void warranty.

The use of any unauthorized mounting bracket will void warranty.

### MB700

Quick Release Roof-Mount Kit



Allows you to easily use the antenna unit as either a roof-mounted or portable antenna.

For temporary use when you don't want to put the antenna unit on the ground, KING offers these two options.

### TR1000

Tripod Mount

Allows you to position your KING One Pro almost anywhere for best line of sight to satellite. Keeps antenna off the ground away from moisture.



### MB500

Mounting Bracket

Includes (2) Hanger Brackets

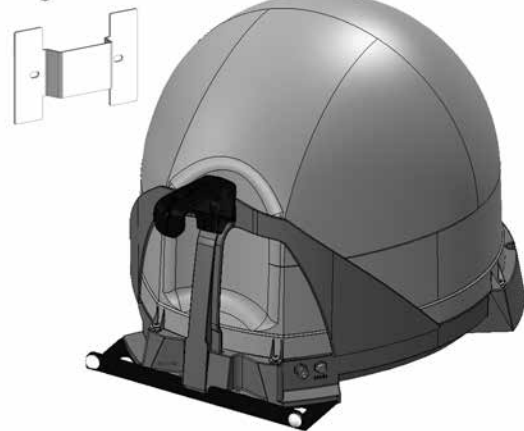

Allows hanging of antenna unit on vehicle window or included hanger bracket.

For stationary use only.  
Vehicle must not be in motion while antenna unit is on window or hanger bracket.

See your dealer or the satellite antenna accessories page at [kingconnect.com](http://kingconnect.com) for details.  
KING antenna not included with purchase of these products.

..... **IMPORTANT POINTS!** .....



The installer is responsible for determining the most appropriate fasteners to secure the antenna unit to the roof. Depending on the roof material, fasteners such as lag screws, well nuts, sheet metal screws, toggle bolts and T anchors may be used, and should always be used in combination with a **roof-compatible** sealant.



The installer is responsible for properly securing the coax cable to the roof (for example, cable ties and cable tie mounting pads).



The installer is responsible for weatherproofing all holes (except drain holes in base) with **roof-compatible** sealant.



If the rubber feet have been installed, remove them from the bottom of the unit. **DO NOT INSTALL UNIT ON ROOF WITH RUBBER FEET IN PLACE.**

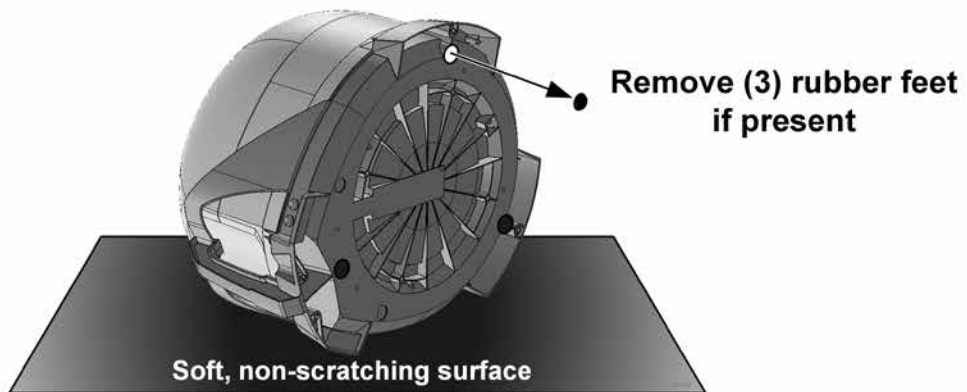

Do not put sharp bends in coax cables. This can reduce signal strength from the antenna.

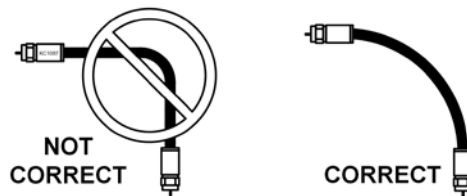

You can cut the coax to length but you must terminate the coax with Snap-n-Seal connectors. Otherwise, bundle and store excess coax in cabinet with receiver.

**SNAP-N-SEAL® CONNECTOR**

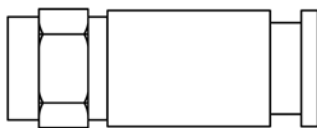

**Thomas and Betts part # SNS 1P6**

**CRIMPER**

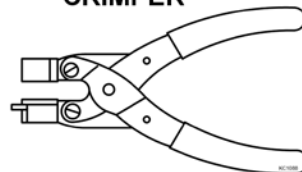

**Thomas and Betts part # SNSUTL**

Connector and crimper sold separately.

## ITEMS YOU WILL NEED

### In the KING One Pro box:

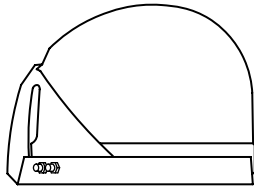

Antenna Unit



Power Inserter  
with Power Supply



Short Coax Cable



50' RG-6  
Coax Cable



(3) Rubber Feet

Do not use rubber feet.  
If installed on antenna unit,  
remove before mounting.

### Additional Items (sold separately):

Programming  
Subscription 

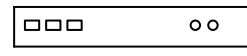

Cable(s)

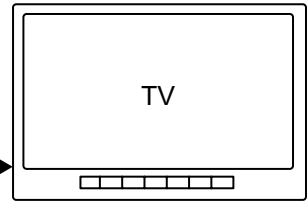

Receiver compatible  
with your service\*

\*Some DIRECTV receivers require additional  
components to enable satellite signal reception (page 9).

Visit [kingconnect.com/support](http://kingconnect.com/support) for additional receiver  
compatibility information.

You will also need a drill and drill bits, roof-compatible sealant, and appropriate fasteners to install all components and wiring.

The CE2000 Cable Entry Cover (sold separately) provides a watertight seal where cables penetrate the roof (see the satellite antenna accessories page at [kingconnect.com](http://kingconnect.com) for more information).



## ANTENNA UNIT LOCATION

**END-USER INSTALLATIONS:** Many RVs are prewired with RG-6 coax cable for satellite antennas. Contact the manufacturer of your RV or your local dealer to verify where this cable is located.

If prewired, run the existing coax cable from the prewired location in the roof to the antenna unit. When choosing the antenna unit location, make sure the prewiring will reach the antenna unit.

1. Select an area on the roof for the antenna unit and the location where the wiring will enter the vehicle through the roof to the satellite receiver inside using the following criteria:
  - A shorter distance between the antenna unit and the satellite receiver is most desirable.
  - Make sure you have enough room to mount the antenna unit.
  - The antenna unit should be mounted on the center line of the vehicle, and not tilted more than 2 degrees in any direction.
  - There must be no line of sight obstructions. Air conditioning units, other antennas, and storage areas that are too close to the antenna unit may prevent the satellite signal from reaching the antenna unit.
  - Mount the antenna unit with the handle to rear of the vehicle.

# ANTENNA UNIT LOCATION

HEIGHT OF OBSTRUCTION	APPROXIMATE MINIMUM DISTANCE TO EDGE OF ANTENNA UNIT
10"	8"
11"	10"
12"	12"
13"	14"
14"	16"
15"	18"
16"	20"

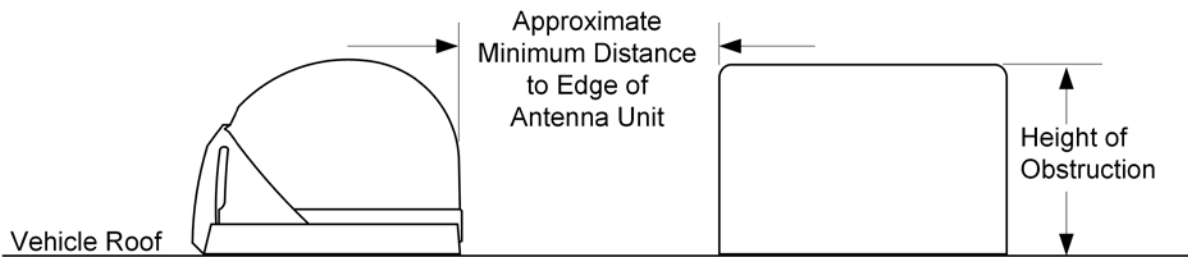

**Do not mount antenna unit too close to obstructions.**

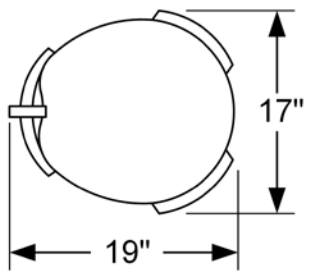

**Choose a location with adequate space.**

**Mount antenna unit on center line of vehicle.**

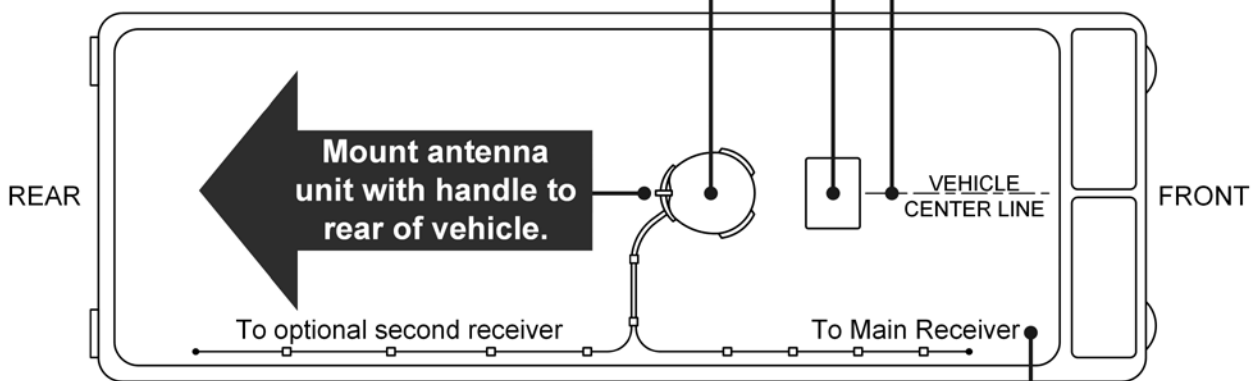

**Try to install antenna unit as close as possible to main receiver to minimize coax length.**



## ANTENNA UNIT MOUNTING



**IF INSTALLED, REMOVE THE (3) RUBBER FEET FROM THE BOTTOM OF THE ANTENNA UNIT. DO NOT ROOF MOUNT ANTENNA UNIT WITH FEET IN PLACE.**



**MAKE SURE YOU READ AND UNDERSTAND ALL OF THE IMPORTANT POINTS ON PAGE 3 BEFORE BEGINNING THE INSTALLATION.**

2. Apply **roof-compatible** sealant to roof around entire area where fasteners will penetrate the roof. Mount the antenna unit using the (4) mounting holes. After mounting unit, seal fastener heads with **roof-compatible** sealant.

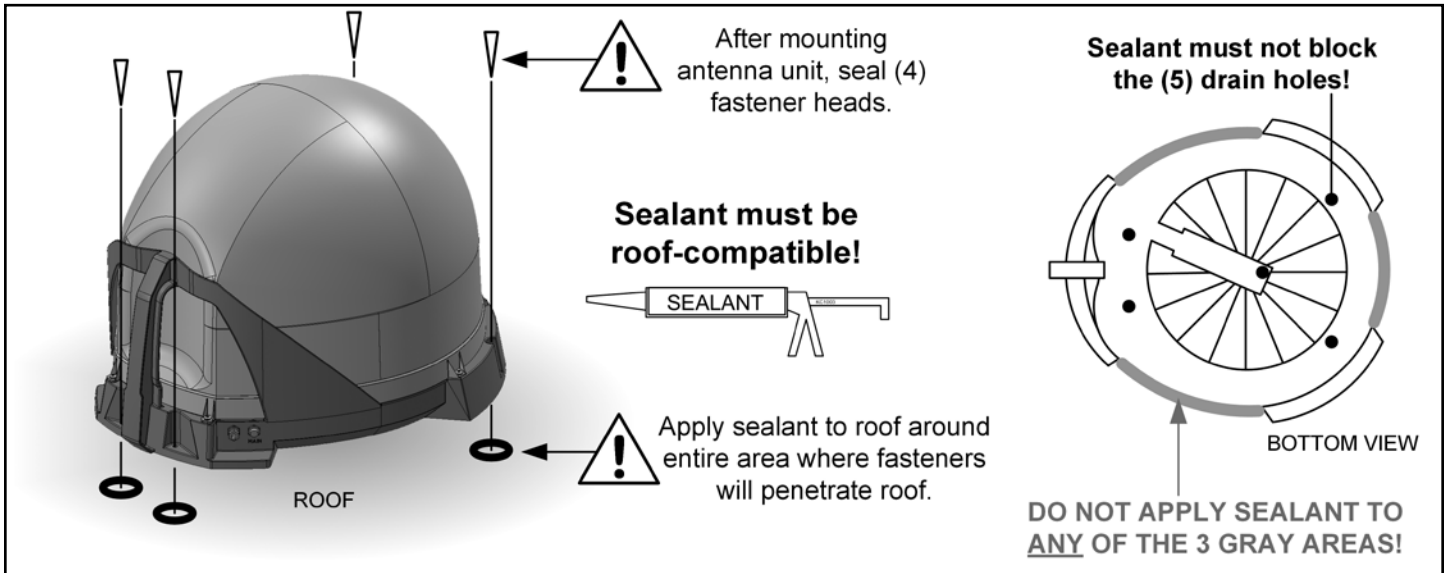

## COAX ROUTING

There are two coax ports on the back of the antenna unit. The one labeled “MAIN” **MUST** be connected to the KING power inserter. The AUX port can be used for an additional receiver, or for DIRECTV SWM installations. Review the wiring diagrams on pages 8-9 before routing your coax.

3. Connect one end of the RG-6 coax cable to the MAIN port and tighten connection (see below). **DO NOT OVER-TIGHTEN.**

If using a second receiver, connect one end of second RG-6 coax (sold separately) to the AUX port. Tighten connection. **DO NOT OVER-TIGHTEN.**

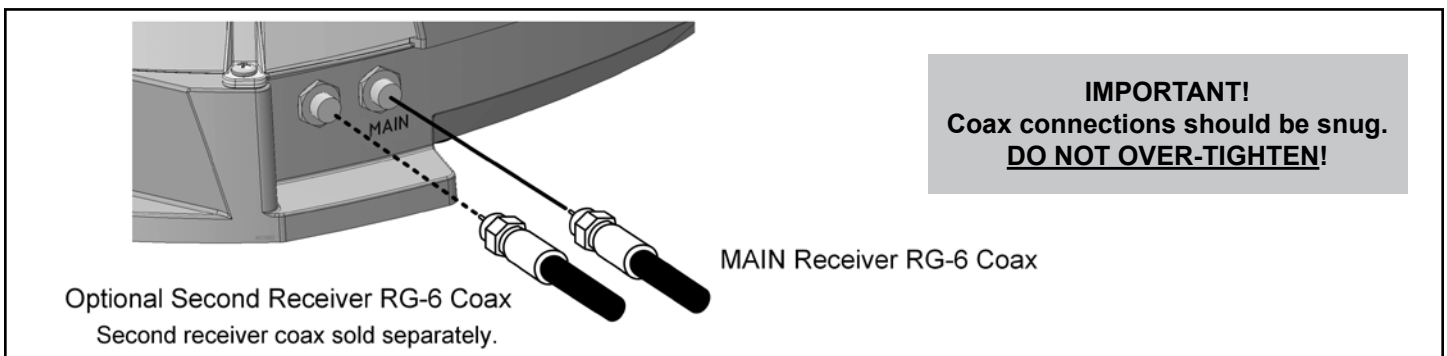



## AVOID SHARP BENDS WHEN ROUTING COAX!

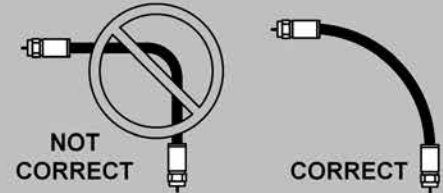

- Run coax from the antenna unit to the roof edge, then along edge to location where coax will be fed into the vehicle. If installing an optional second receiver, run second coax to location where it will enter the vehicle. Secure (both) coax to roof every 12-18 inches (see below).
- Drill 3/4" hole through the roof and into the cabinet where receiver is stored. Feed coax down through hole. Seal opening with roof-compatible sealant so that it is completely waterproof (inside and outside of the 3/4" hole). Repeat for second coax if present.

## TYPICAL ROOF INSTALLATION - OVERHEAD VIEW

Installer is responsible for determining proper roof-compatible sealant.

All holes for cables and fasteners must be sealed so they are completely waterproof.

AVOID SHARP BENDS  
WHEN ROUTING COAX!

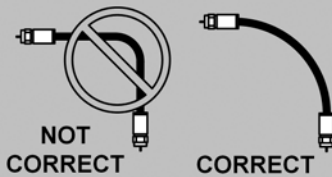

### OPTIONAL: OEM INSTALLATION AND END-USERS WITH CABLE ENTRY COVER:

Fasten cable entry cover to roof with appropriate sealant and roof fasteners.

#### IMPORTANT!

Installer is responsible for  
determining proper fasteners.

Mounting holes, perimeter of cable  
entry cover and cable opening of  
cable entry cover must be sealed  
so they are completely waterproof.

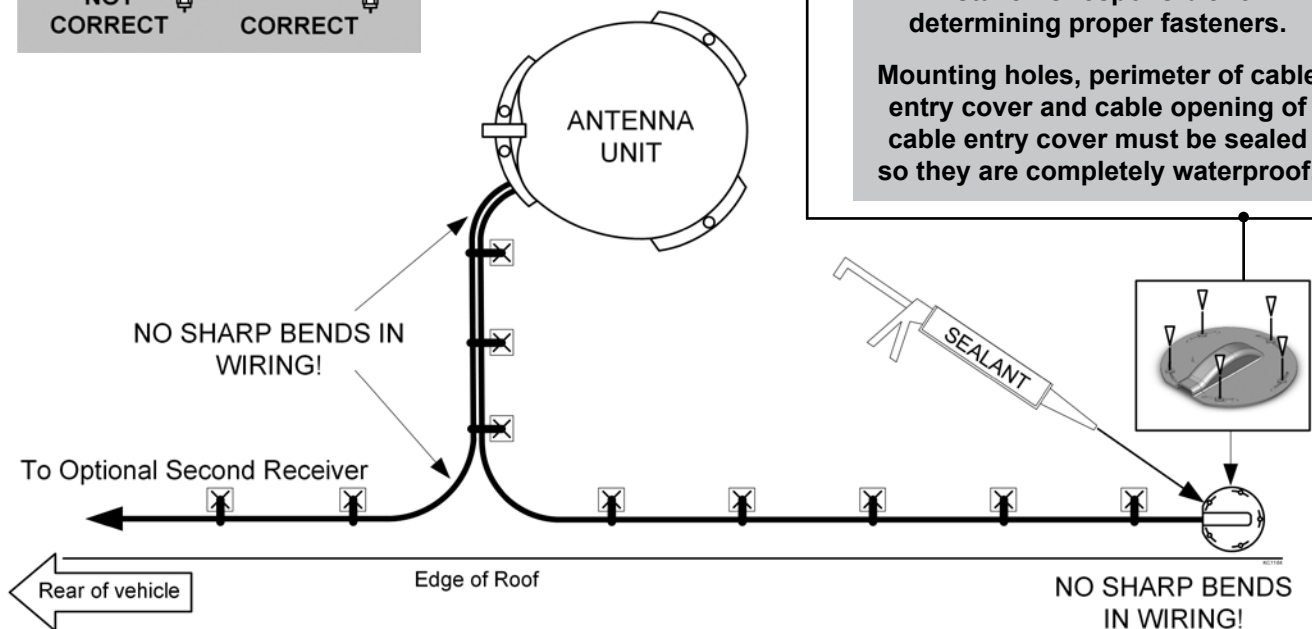

- Make interior connections shown on next page.

# INTERIOR CONNECTIONS: DISH®, BELL™ AND DIRECTV®

Use this page for DISH, Bell, and DIRECTV connections.

**IMPORTANT!** If you have a DIRECTV receiver H/HR25 or higher, make the connections shown on page 9 (requires DSWM30 Kit - sold separately).



**HAND-TIGHTEN COAX. OVER-TIGHTENING CAN DAMAGE CONNECTIONS.**

**AVOID SHARP BENDS WHEN ROUTING COAX!**

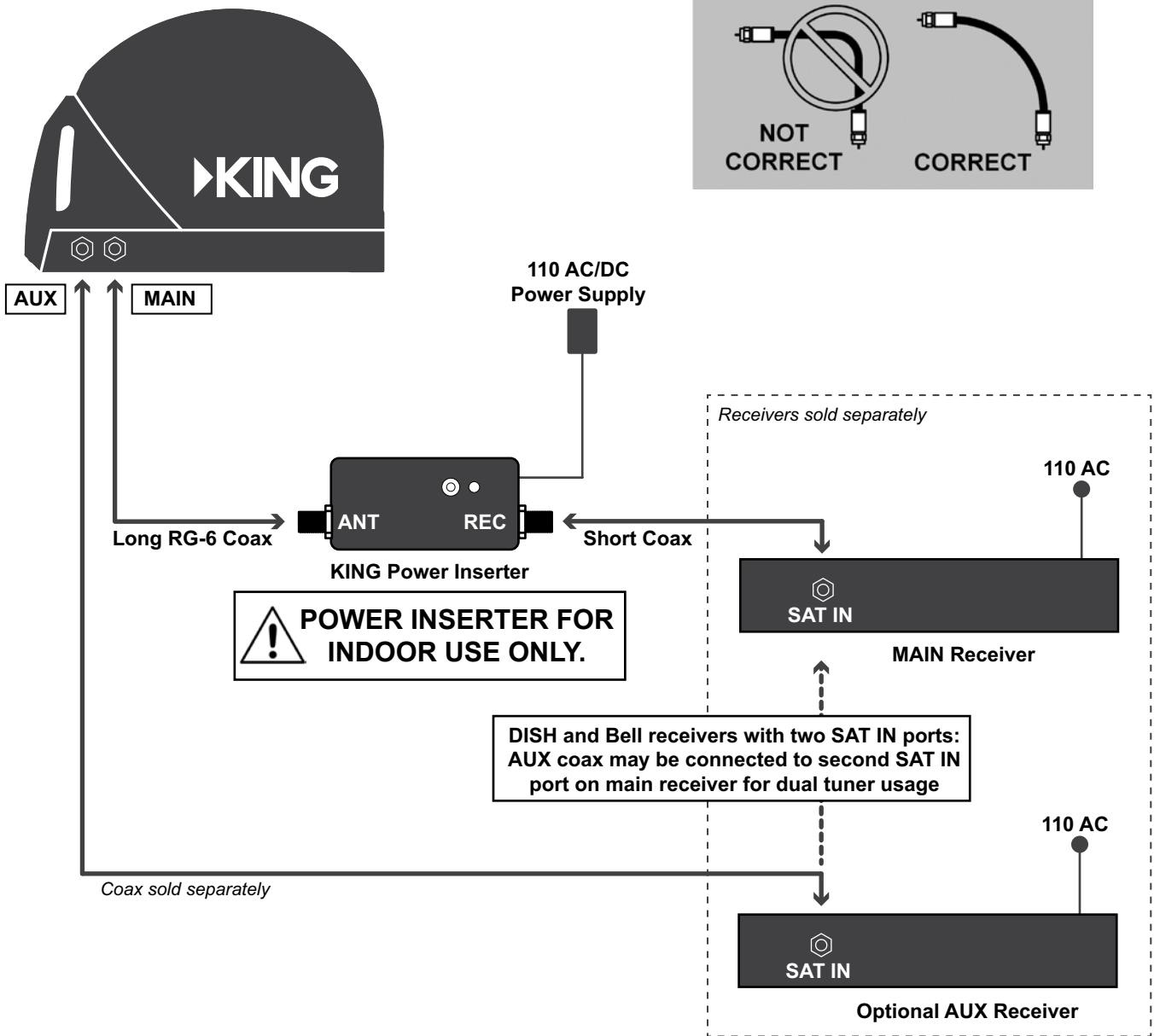
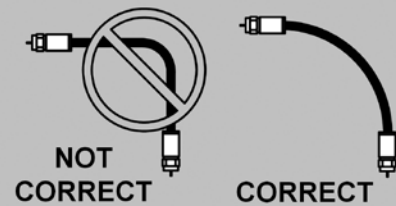

**IMPORTANT! DIRECTV receivers H/HR25 and higher require use of components shown below.**

**NOTE:** When using this connection diagram, you will not receive programming from the 119 satellite.

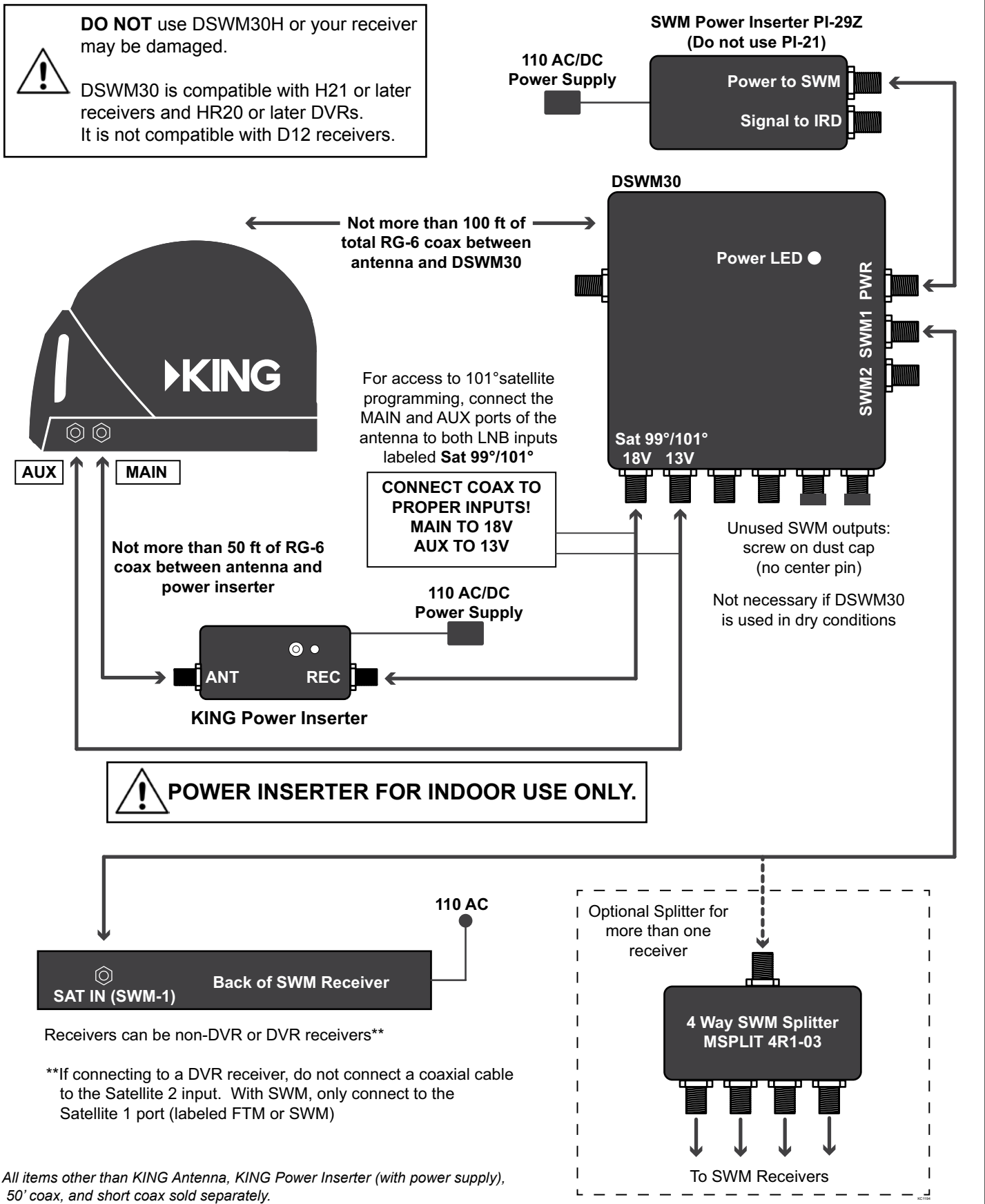

**Simply better, by design.™**



---

11200 Hampshire Avenue South, Bloomington, MN 55438  
PH 952.922.6889 || FAX 952.922.8424 || [kingconnect.com](http://kingconnect.com)

© KING 2018      23359 Rev A

Trademarks are the sole property of their respective owners.