



MOUNTING BRACKET KIT INSTALLATION INSTRUCTIONS

KIT# 3109-1

09/25/15
KS

ROADMASTER, Inc. 6110 NE 127th Ave. Vancouver, WA 98682 360-896-0407 fax 360-735-9300 www.roadmasterinc.com

ROADMASTER, INC.

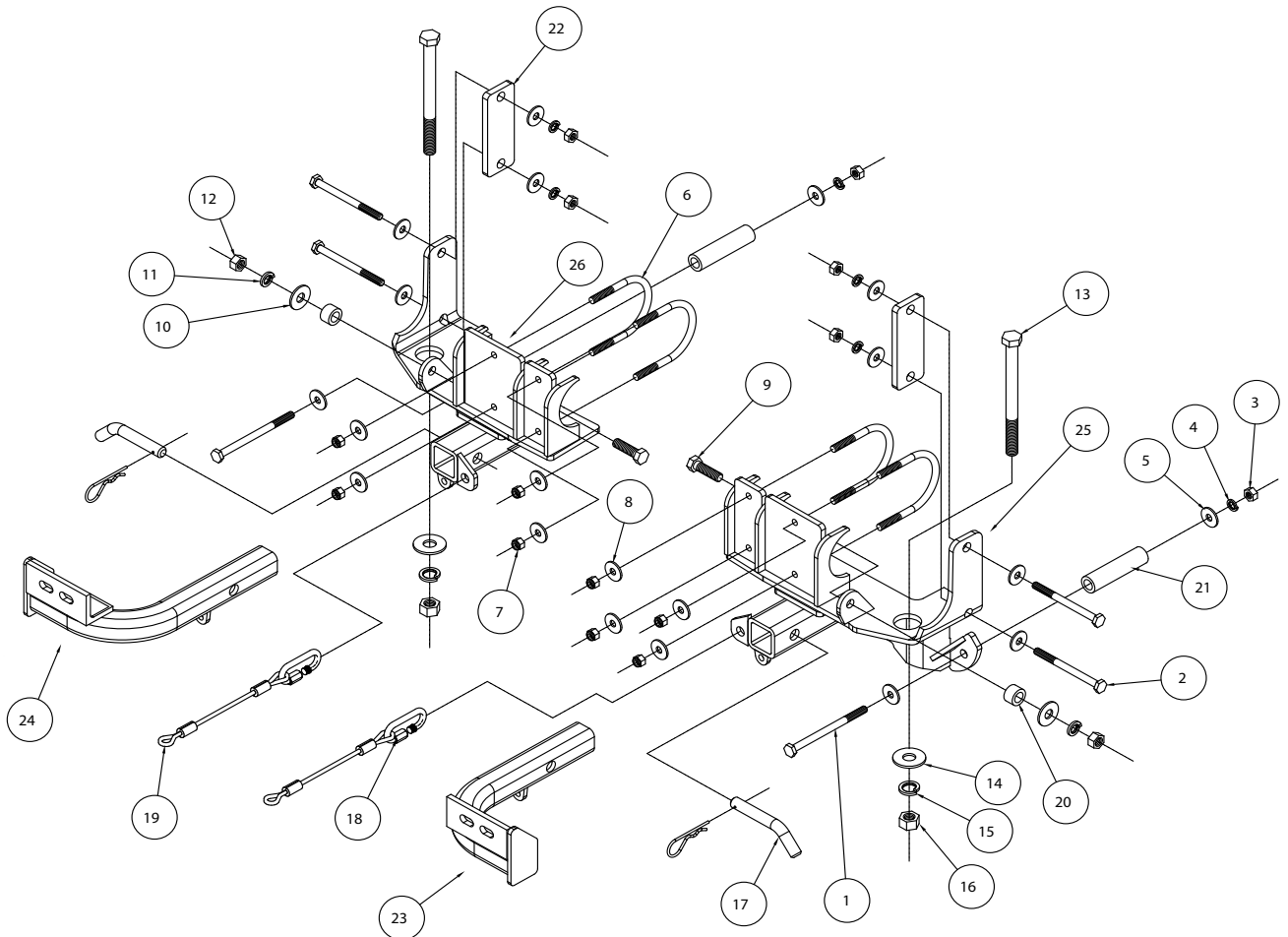

ITEM	QTY	NAME	PART #
1	2	10mm x 1.5 x 140MM BOLT	356124-00
2	4	10mm x 1.5 x 120MM BOLT	356121-00
3	6	10mm x 1.5 NUT	356230-00
4	6	10mm LOCK WASHER	355715-00
5	12	10mm FENDER WASHER	355716-00
6	4	3/8" U-BOLT	357024-00
7	8	3/8" NYLON LOCK NUT	350255-00
8	8	3/8" FLAT WASHER	350304-00
9	2	1/2" x 1 3/4" BOLT	350396-00
10	2	1/2" FLAT WASHER	350308-00
11	2	1/2" LOCK WASHER	350309-00
12	2	1/2" NUT	350258-00
13	2	5/8" X 7 1/2" BOLT	350148-00
14	2	5/8" FLAT WASHER	350312-00
15	2	5/8" LOCK WASHER	350313-00
16	2	5/8" NUT	350262-00
17	2	DRAW PIN/SPRING PIN	357035-00
18	2	QUICK LINK	200008-00
19	2	8000 lb. SAFETY CABLES	650648-08
20	2	1" O.D. ROUND TUBE x 5/8"	A-000156
21	2	1" O.D. ROUND TUBE x 4"	A-000374
22	2	3/8" x 2" x 5 1/2" BACKING PLATE	A-000375
23	1	DRIVER SIDE ARM	C-000195
24	1	PASSENGER SIDE ARM	C-000196



MOUNTING BRACKET KIT INSTALLATION INSTRUCTIONS

KIT# 3109-1

09/25/15
KS

ROADMASTER, Inc. 6110 NE 127th Ave. Vancouver, WA 98682 360-896-0407 fax 360-735-9300 www.roadmasterinc.com

This is one of our XL series brackets, which allows the visible front portion of the bracket to be easily removed from the front of the vehicle (Fig.A and Fig.B). The bracket consists of a main receiver braces, two removable front braces, two rear braces and a hardware pack. The main receiver brace mount below the front bumper core (Fig.A) and use the stock bumper core mounts and tubular cross member for the front mounts and the side of the frame rails for the back mounting points. The front braces then insert into the receiver brace under the front bumper. Minor trimming will be needed to refit the front bumper and fascia. On some models, a lower radiator guard will have to be removed. The front grille, air deflector and bumper will have to be removed to access the mounting area.

Before starting the installation, lay out the kit components in order, as they will be used. This will give you a visual idea of how the components work, and will also confirm that everything is present and accounted for.



Fig.A



Fig.B

IMPORTANT: All brackets **must** be assembled with all the bolts left loose for final adjustment and positioning (before tightening) unless otherwise instructed. All bolts **must** be torqued for proper strength. If more than one bolt is used per fastening point, the diagram may only show one.

- Use flat washers over all slotted holes
- Use lock washers on all fasteners

ROADMASTER Limited Warranty, including One-Year Conditional Warranty Text and Product Registration Card, in Carton.

WARNING

Failure to follow these instructions can result in property damage, personal injury or even death.

- **Installation of most mounting brackets requires moderate mechanical aptitude and skills.** We strongly recommend professional installation by an experienced installer.
- **The installer must read the instructions and use all bolts and parts supplied.** Failure to do so could result in loss of the towed vehicle.
- **Use Loctite® Red** on all bolts used for mounting this bracket.
- **Every 3,000 miles, the owner must inspect the fasteners** for proper torque, according to the bolt torque requirements chart on the last page of these instructions. **The owner must also inspect all mounts and brackets for cracks or other signs of fatigue every 3,000 miles.** Failure to do so could result in loss of the towed vehicle.
- **The owner must check the vehicle manufacturer's instructions for the proper procedure(s) to prepare the vehicle for towing.** Some vehicles must be equipped with a transmission lube pump, an axle disconnect, driveline disconnect or free-wheeling hubs before they can be towed. Failure to properly equip the vehicle will cause severe damage to the transmission.
- **If running changes were made** by the vehicle manufacturer after this bracket was designed, some bolts or other fasteners in the hardware pack may no longer be the correct size. **It is the installer's responsibility** to verify that the bracket is securely fastened to the vehicle and fitted with the correct hardware to account for these changes. Failure to securely fasten the bracket could result in loss of the towed vehicle.
- If the towed vehicle has been in an accident, it must be properly repaired before attaching the bracket. **Do not install the bracket if any structural frame damage is found.** Failure to repair the damage could result in the loss of the towed vehicle.
- Roadmaster manufactures many styles of brackets. **If your bracket has removable arms, they must be removed before driving the vehicle, unless the arms can be pinned or padlocked in place.** If not secured, the arms could vibrate out, resulting in non-warranty damage or personal injury.
- Some motorhome chassis have such a tight turning radius that you can damage your motorhome, towed vehicle, tow bar or bracket while turning sharply. **Before getting on the road, test your turning radius in an empty parking lot.** Turning too sharply could result in non-warranty damage to towing system, motorhome and/or towed vehicle.
- **Do not back up with the towed vehicle attached** or non-warranty damage will occur to your towing system, motorhome and/or towed vehicle.
- **The safety cables must connect the towing vehicle to the towed vehicle frame to frame, with the cables crossed, with enough slack for sharp turns.** Refer to the cable instructions for proper routing. Failure to leave enough slack in the safety cables, or failure to connect the safety cables frame to frame, will result in the loss of the towed vehicle.
- This bracket is designed for use with ROADMASTER tow bars and ROADMASTER adaptors only. **Using this bracket with other brands, without an approved ROADMASTER adaptor, may result in non-warranty damage or injury.**
- **Do not use this document for custom fabrication,** as it may not show all parts or structural components. Custom fabrication or an attempt to copy this bracket design could result in loss of the towed vehicle.
- Upon final installation, **the installer must inspect the bracket to ensure adequate clearance, particularly around hoses, air conditioner lines, radiators, etc.,** or non-warranty damage to the towed vehicle will result.
- **This bracket is only warranted for the original installation.** Installing a used bracket on another vehicle is not recommended and will void the warranty.



MOUNTING BRACKET KIT INSTALLATION INSTRUCTIONS

KIT# 3109-1

09/25/15
KS

ROADMASTER, Inc. 6110 NE 127th Ave. Vancouver, WA 98682 360-896-0407 fax 360-735-9300 www.roadmasterinc.com

Trailblazer, Rainier and Ascender Instructions

This bracket kit fits the 2002-2009 Chevrolet Trail Blazer, the 2004-2007 Buick Rainier, the 2003-2008 Isuzu Ascender, and the 2005-2009 GMC Denali. Follow the instructions below for the Trail Blazer, Rainier and the Ascender Installation. For the Denali installation, see the separate section included in these instructions.

Important: please use all supplied bolts and parts and read all instructions carefully before beginning this installation. The majority of questions you may have can be answered within the text, and proper installation will ensure safe and secure travel. Now, begin the installation.

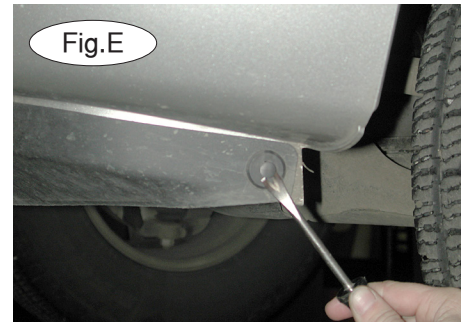
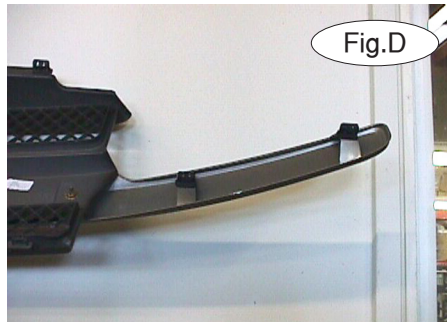
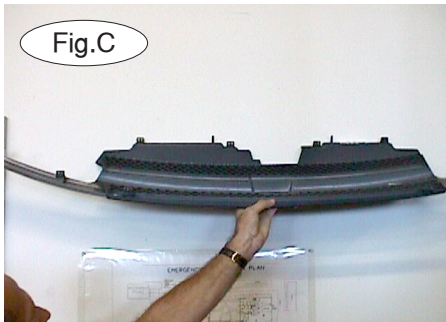

1. The first step is to remove the grille, which is held on with 11 spring clips. Pull forward on the top of the grille and the sides. This should pop the top retainer clips loose so that you can pull up and release the two bottom plastic retainer tabs (Fig.C,D). Set the grille aside.

2. To remove the bumper fascia, remove two plastic fasteners per side on the bottom of the fascia (Fig.E), two 10mm (head) screws (on each side) and one plastic fastener (center) in the top of the fascia (Fig.F), and four plastic fasteners under the bumper (Fig.G). Now, unplug the fog lights, if the vehicle is so equipped, and then pull forward to remove the bumper fascia.

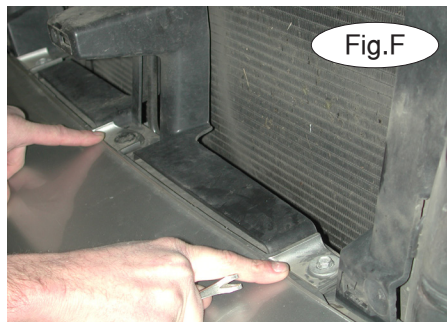



MOUNTING BRACKET KIT INSTALLATION INSTRUCTIONS

KIT# 3109-1

09/25/15
KS

ROADMASTER, Inc. 6110 NE 127th Ave. Vancouver, WA 98682 360-896-0407 fax 360-735-9300 www.roadmasterinc.com

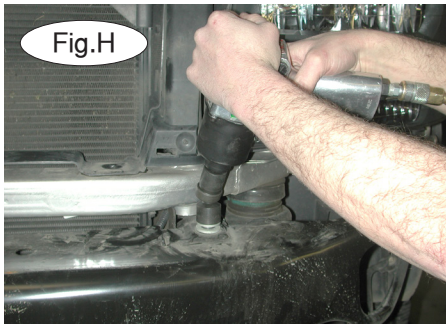

3. Next, remove two 21mm (head) bumper bolts, one on each side, holding the bumper core (Fig.H). Then remove a plastic fastener (one on each side), attaching the fender liner to the bumper core (Fig.I).

4. Pull forward to lift the bumper core off (Fig.J). Now, pull the plastic air deflector from between the frame rails. The plastic air deflector can be either trimmed to fit or left off.

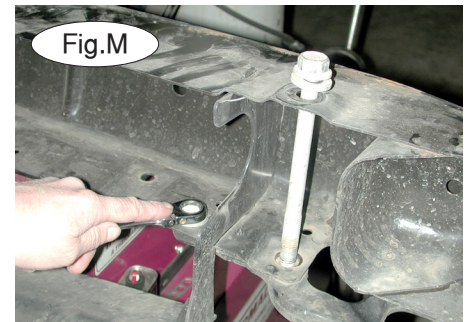
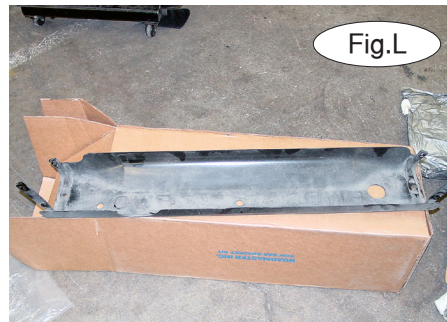
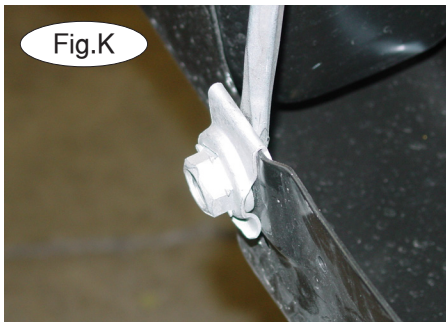

5. Prepare the bumper core for remounting by removing the large spring retainer nuts located on the bottom of the bumper core on each side (Fig.K).

Note: the large bolts removed in step 3 and the spring retainer nuts will be replaced by kit hardware.

Note: if the vehicle is equipped with a lower steel radiator guard (Fig.L), remove it (three 13mm (head) bolts per side and six spring nuts).

Note: if the vehicle is equipped with tow hooks, remove them by removing the 15mm (head) bolt on each side (Fig.M). Retain all removable parts so they can be replaced if the bracket is ever removed from the vehicle.

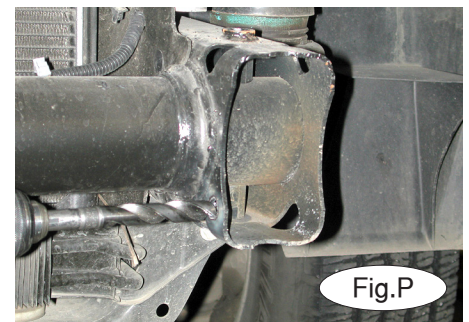
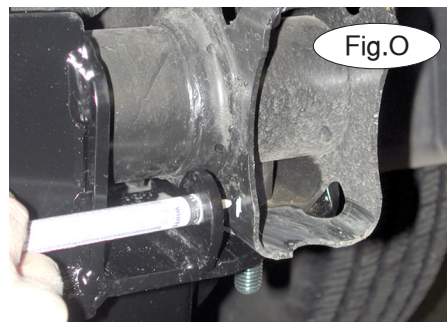
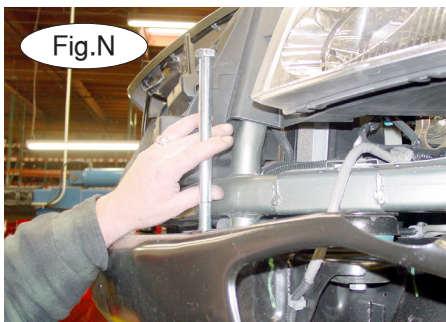

6. Temporarily install the driver side brace – set the driver side brace against the frame cross brace and drop one of the supplied 5/8" x 7 1/2" bolts through the large bumper mount on the end of the frame, and through the driver side brace (Fig.N). Thread a 5/8" nut, lock washer and flat washer onto the bolt. Finger tighten only at this time.

7. Mark the inside frame wall for drilling, using the brace as a template (Fig.O). Remove the brace temporarily and drill a 1/2" hole through the side of the frame (Fig.P), then replace the brace.



MOUNTING BRACKET KIT INSTALLATION INSTRUCTIONS

KIT# 3109-1

09/25/15
KS

ROADMASTER, Inc. 6110 NE 127th Ave. Vancouver, WA 98682 360-896-0407 fax 360-735-9300 www.roadmasterinc.com

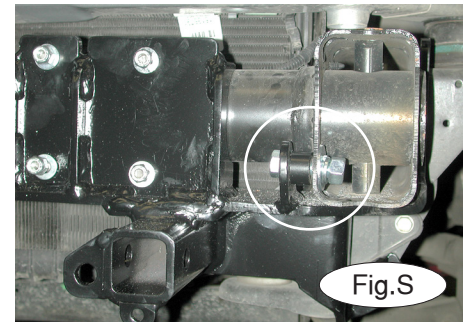
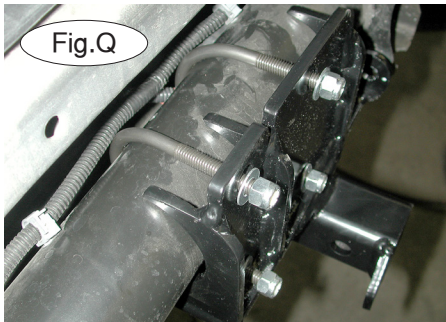

8. Position two 3/8" U bolts against the front frame cross brace (with the air bag sensor wiring harness behind the U bolts) and through the receiver brace. Secure with 3/8" flat washers and Nylock nuts (Fig.Q). Leave loose for now.

Note: the outside U bolt (on each side) will be close to the air bag sensor, but will allow sufficient clearance on both sides. Figure R shows the clearance on the passenger side.

9. Bolt through the side of the frame rail and brace with a 1/2" x 1 3/4" bolt, 1" x 5/8" pipe spacer, flat washer, lock washer and nut. Be sure to place the pipe spacer between the brace and the side of the frame (Fig.S).

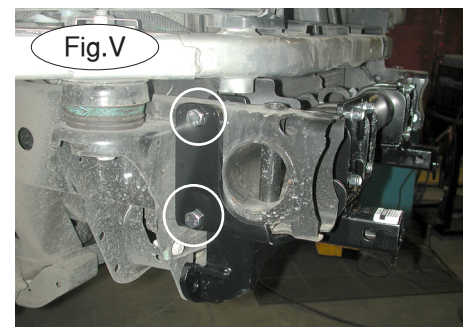
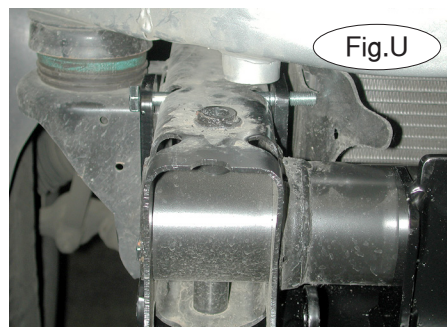
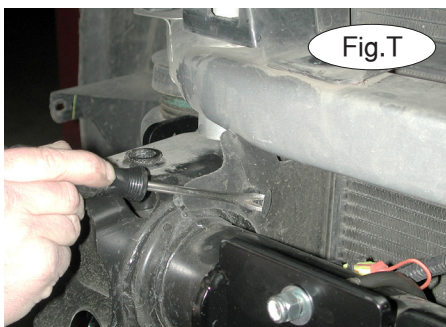

10. Remove the plastic pen holding the air deflector to the frame rail (Fig.T), to gain access to the pre-drilled holes in the frame rail. Install two 10mm x 1.5 x 120mm bolts through one of the 3/8" x 2" x 5 1/2" backing plates, the frame and the side of the receiver brace (Fig.U). Use 10mm nuts, lock washers and fender washers to hold the backing plate in place. Figure V shows both bolts in place.

11. The back of the receiver brace should now be against the cab support bracket on the side of the frame, and the remaining lower mounting hole should line up with the existing hole in the side in the bracket. Put a 10mm x 1.5 x 140mm bolt with a 10mm fender washer through the lower mounting hole in the brace, the cab support bracket and a 1" O.D. x 4" x .188 wall pipe spacer and the other side of the cab support. Finish with a 10mm fender washer, lock washer and 10mm x 1.5 nut.

12. Tighten all the bolts to the torque specifications listed at the end of these instructions.

13. Repeat steps 6 through 12 for the passenger side.

14. To reinstall the bumper core, remove the 7 1/2" bolts and hold the bumper core in position. Mark the bottom of the bumper core for clearance (approximately 3 1/2" x 9") and trim to fit as needed (Fig.Y). Also, a small area next to the 7 1/2" bolt may need trimming or grinding. *Note:* a portion of the center section of the grille, on both sides of the fascia, will need to be trimmed (use the white marker line in Figure Z as a reference.), in order to accommodate the removable front braces. Or, you may remove the grille entirely.

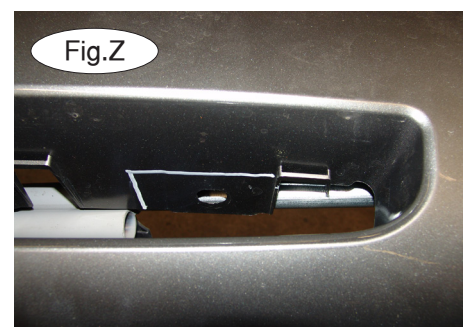
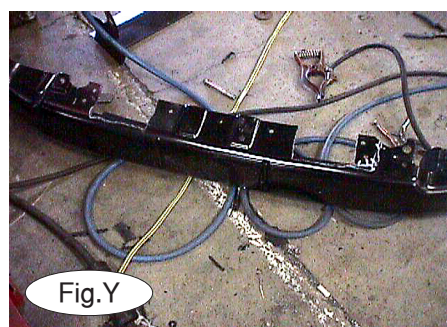



MOUNTING BRACKET KIT INSTALLATION INSTRUCTIONS

KIT# 3109-1

09/25/15
KS

ROADMASTER, Inc. 6110 NE 127th Ave. Vancouver, WA 98682 360-896-0407 fax 360-735-9300 www.roadmasterinc.com

15. Once a fit has been established, install the bumper core and fascia with the 7½" bolts, bolting through the receiver brace on each side (Fig.AA). Torque the 5/8" bolts to 130 ft./lbs..

16. Continue installing the fasteners and grille, reversing step 1. *Note:* only two of the plastic fasteners under the license plate opening will be replaced.

17. Insert the front braces into the receiver brace and secure with the 5/8" draw pins and 3/16" spring pins (Fig.BB).

18. Install the tow bar according to the manufacturer's instructions.

19. Attach the included 8" safety cables to the holes provided in the receiver brace with the included cable links. Connect the other end to the tow vehicle's safety cables and the tow bar.

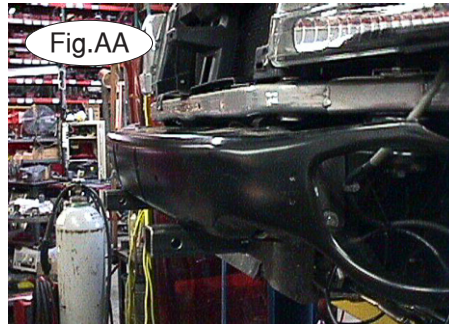



MOUNTING BRACKET KIT INSTALLATION INSTRUCTIONS

KIT# 3109-1

09/25/15
KS

ROADMASTER, Inc. 6110 NE 127th Ave. Vancouver, WA 98682 360-896-0407 fax 360-735-9300 www.roadmasterinc.com

Denali Instructions

This bracket kit fits the 2005-2009 GMC Denali, the 2002-2009 Chevrolet Trail Blazer, the 2004-2007 Buick Rainier, and the 2003-2008 Isuzu Ascender. Follow the instructions below for the Denali installation. For the Trail Blazer, Rainier and Ascender installation, see the separate section included in these instructions.

Important: please use all supplied bolts and parts and read all instructions carefully before beginning this installation. The majority of questions you may have can be answered within the text, and proper installation will ensure safe and secure travel. Now, begin the installation.

This is one of our XL series brackets, which allows the visible front portion of the bracket to be easily removed from the front of the vehicle (Fig.A and Fig.B). The bracket consists of a main receiver braces, two removable front braces, two rear braces and a hardware pack.

The main receiver braces mount below the front bumper core (Fig.A) and use the stock bumper core mounts and tubular cross member for the front mounts and the side of the frame rails for the back mounting points. The rear braces bolt to the back of the frame, through a tubular spacer, and then to the back of the main receiver brace. The front braces then insert into the receiver brace under the front bumper. Minor trimming will be needed to refit the fascia.

Before starting the installation, lay out the kit components in order, as they will be used. This will give you a visual idea of how the components work, and will also confirm that everything is present and accounted for.



Fig.A



Fig.B

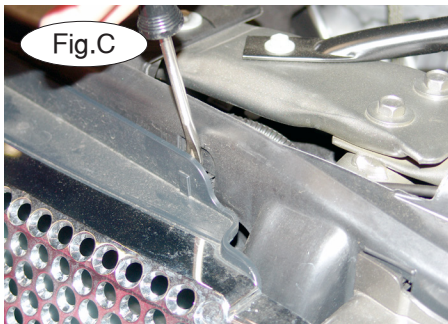

Fig.C



Fig.D

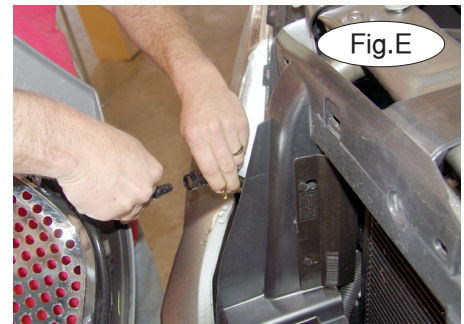

Fig.E

1. Start by removing six plastic clips on the top of the grille, attaching the grille to the hood latch support (Fig.C) – insert the end of a screwdriver into the top of each clip, and pry the clips out.

2. Remove the grille by pulling straight up (Fig.D).

3. If the vehicle is equipped with headlight washers, release the washer fitting on the lower passenger side of the grille (Fig.E).

4. Tie off the headlight washer hose line, so washer fluid will run off (Fig.F)

5. Remove one plastic fastener (in the center) and two 10mm bolts attaching the fascia to the core support (Fig.G).

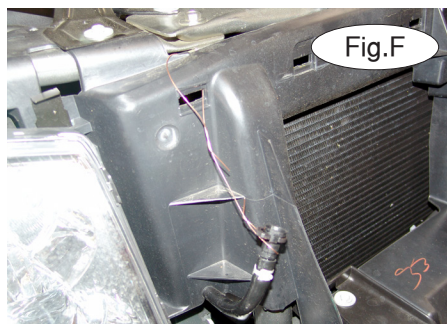

Fig.F

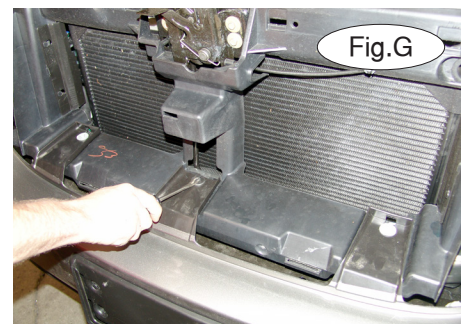

Fig.G



MOUNTING BRACKET KIT INSTALLATION INSTRUCTIONS

KIT# 3109-1

09/25/15
KS

ROADMASTER, Inc. 6110 NE 127th Ave. Vancouver, WA 98682 360-896-0407 fax 360-735-9300 www.roadmasterinc.com

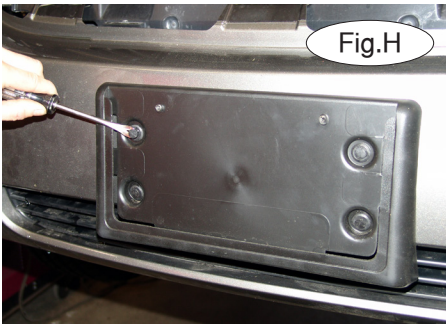

Fig.H

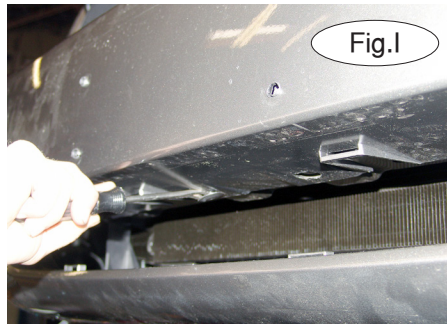

Fig.I

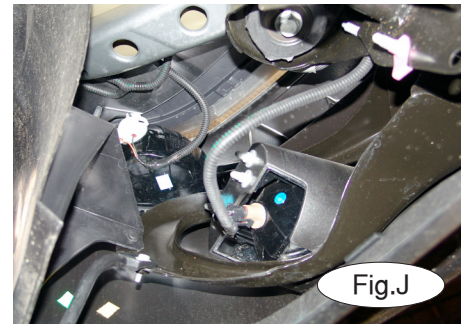

Fig.J

6. Remove four plastic fasteners attaching the license plate holder to the fascia (Fig.H), and remove the license plate holder.
7. There are eight plastic tabs holding the lower grille in place. From behind the lower grille, pull down on each tab to release them.
8. Remove four plastic fasteners across the top of the lower grille (Fig.I).
9. On both sides, unplug the fog lights and turn signals (Fig.J).

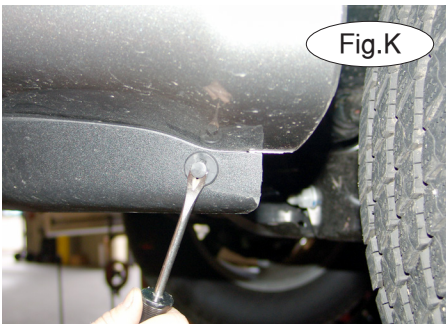

Fig.K



Fig.L

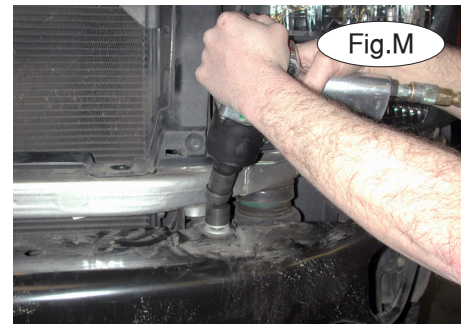

Fig.M

10. On each side, remove one plastic fastener at the lower bottom corner of the fascia (Fig.K).
11. Pull forward on each side of the fascia to remove it (Fig.L).
12. Next, remove two 21mm (head) bumper bolts, one on each side, holding the bumper core (Fig.M).



Fig.N

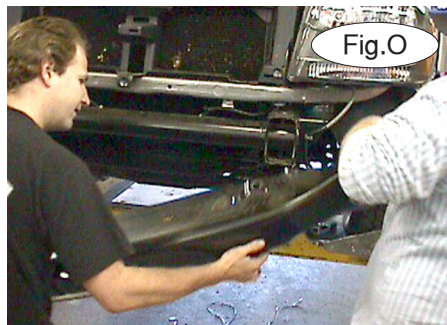

Fig.O

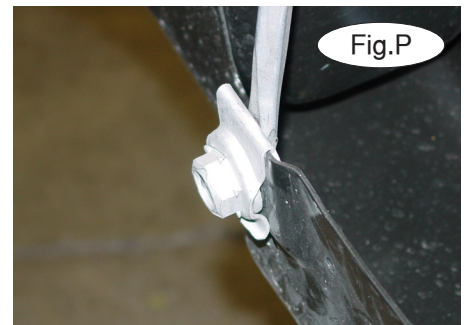

Fig.P

13. Then, remove two plastic fasteners, one on each side, attaching the fender liner to the bumper core (Fig.N).
14. Prepare the bumper core for remounting by removing the large spring retainer nuts located on the bottom of the bumper core on each side (Fig.P).

Note: the large bolts removed in step 12 and the spring retainer nuts will be replaced by kit hardware.



MOUNTING BRACKET KIT INSTALLATION INSTRUCTIONS

KIT# 3109-1

09/25/15
KS

ROADMASTER, Inc. 6110 NE 127th Ave. Vancouver, WA 98682 360-896-0407 fax 360-735-9300 www.roadmasterinc.com

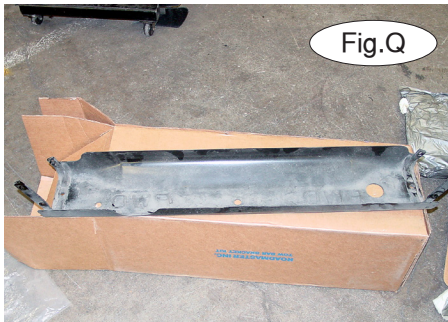

Fig.Q

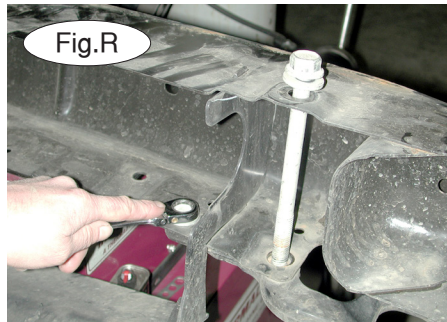

Fig.R

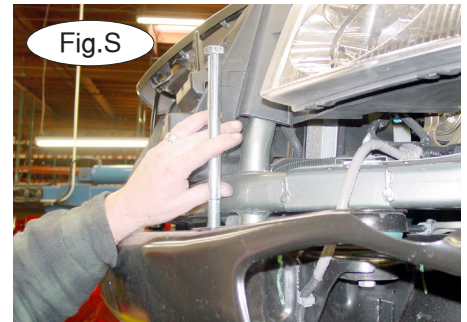

Fig.S

Note: if the vehicle is equipped with a lower steel radiator guard (Fig.Q), remove it (three 13mm (head) bolt per side and six spring nuts) and discard it.

Note: if the vehicle is equipped with tow hooks, remove them by removing a 15mm (head) bolt, on each side (Fig.R).

16. Temporarily install the driver side brace – Set the driver side brace against the frame cross brace and drop one of the supplied 5/8" x 7 1/2" bolts through the large bumper mount on the end of the frame, and through the driver side brace (Fig.S). Thread a 5/8" nut, lock washer and flat washer onto the bolt. Finger tighten only at this time.

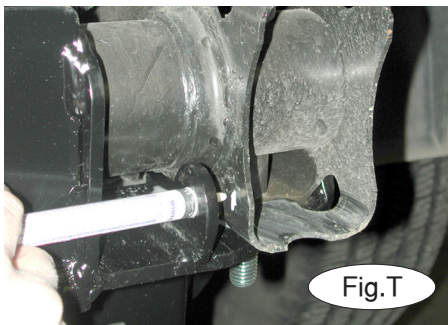

Fig.T

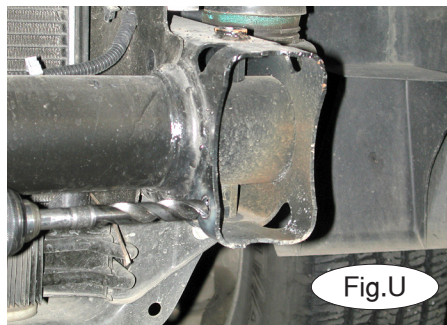

Fig.U

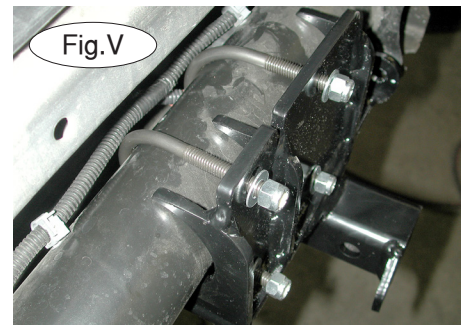

Fig.V

17. Mark the inside frame wall for drilling, using the brace as a template (Fig.T). Remove the brace temporarily and drill a 1/2" hole through the side of the frame (Fig.U), then replace the brace.

18. Position two 3/8" U bolts against the front frame cross brace (with the air bag sensor wiring harness behind the U bolts) and through the receiver brace. Secure with 3/8" flat washers and Nylock nuts (Fig.V). Leave loose for now.

Note: the outside U bolt (on each side) will be close to the air bag sensor, but will allow sufficient clearance on both sides. Figure W shows the clearance on the passenger side.

19. Bolt through the side of the frame rail and brace with a 1/2" x 1 3/4" bolt, 1" x 5/8" pipe spacer, flat washer, lock washer and nut. Be sure to place the pipe spacer between the brace and the side of the frame (Fig.X).



Fig.W

Air Bag
Sensor
Clearance

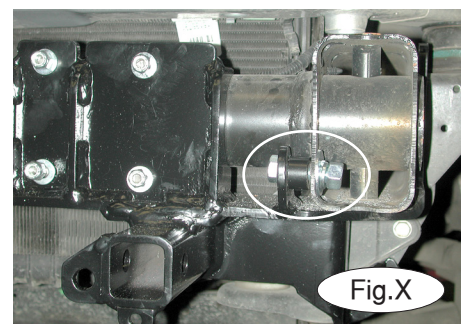

Fig.X



MOUNTING BRACKET KIT INSTALLATION INSTRUCTIONS

KIT# 3109-1

09/25/15
KS

ROADMASTER, Inc. 6110 NE 127th Ave. Vancouver, WA 98682 360-896-0407 fax 360-735-9300 www.roadmasterinc.com

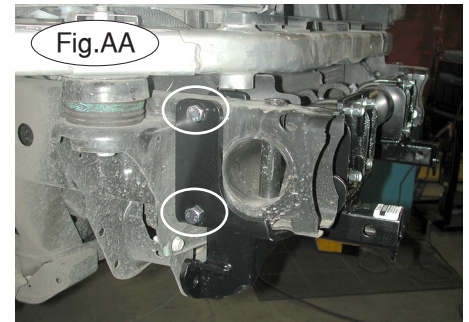
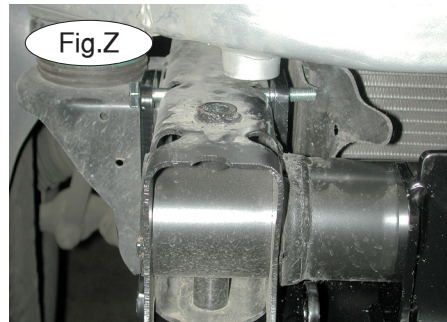
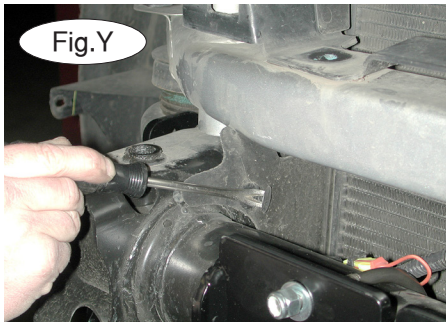

20. Remove the plastic pen holding the air deflector to the frame rail (Fig.Y), to gain access to the pre-drilled holes in the frame rail. Install two 10mm x 1.5 x 120mm bolts through one of the 3/8" x 2" x 5 1/2" backing plates, the frame and the side of the receiver brace (Fig.Z). Use 10mm nuts, lock washers and fender washers to hold the backing plate in place. Figure AA shows both bolts in place.

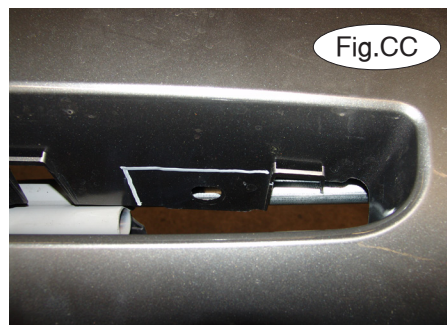
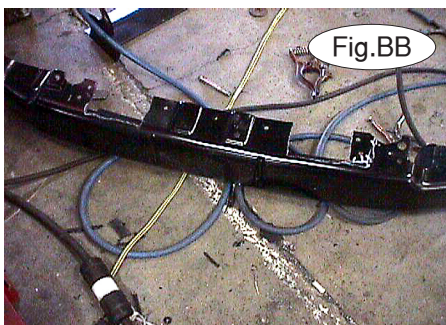

21. The back of the receiver brace should now be against the cab support bracket on the side of the frame, and the remaining lower mounting hole should line up with the existing hole in the side in the bracket. Put a 10mm x 1.5 x 140mm bolt with a 10mm fender washer through the lower mounting hole in the brace, the cab support bracket and a 1" O.D. x 4" x .188 wall pipe spacer and the other side of the cab support. Finish with a 10mm fender washer, lock washer and 10mm x 1.5 nut.

22. Tighten all the bolts to the torque specifications found at the end of these instructions.

23. Repeat steps 16 through 22 for the passenger side.

24. To reinstall the bumper core, remove the 7 1/2 bolts and hold the bumper core in position. Mark the bottom of the bumper core for clearance (approximately 3 1/2" x 9") and trim to fit as needed (Fig.BB). Also, a small area next to the 7 1/2" bolt may need trimming or grinding.

A portion of the center section of the grille, on both sides of the fascia, will need to be trimmed also (use the white marker line in Figure CC as a reference), in order to accommodate the removable front braces. Or, you may remove the grille entirely. Figure DD shows the trimmed grille.

25. Once a fit has been established, install the bumper core and fascia with the 7 1/2" bolts, bolting through the receiver brace on each side (Fig.EE). Torque the 5/8" bolts to 130 ft./lbs.





MOUNTING BRACKET KIT INSTALLATION INSTRUCTIONS

KIT# 3109-1

09/25/15
KS

ROADMASTER, Inc. 6110 NE 127th Ave. Vancouver, WA 98682 360-896-0407 fax 360-735-9300 www.roadmasterinc.com

26. Continue installing the fasteners and grille (if you are reinstalling the grille), reversing the steps you used to remove them. *Note:* only two of the plastic fasteners under the license plate opening will be replaced.

27. Insert the front braces into the receiver brace and secure with the 5/8" draw pins and 3/16" spring pins (Fig.FF).

28. Install the tow bar according to the manufacturer's instructions.

29. Attach the included 8" safety cables to the holes provided in the receiver brace with the included cable links. Connect the other end to the tow vehicle's safety cables and the tow bar.

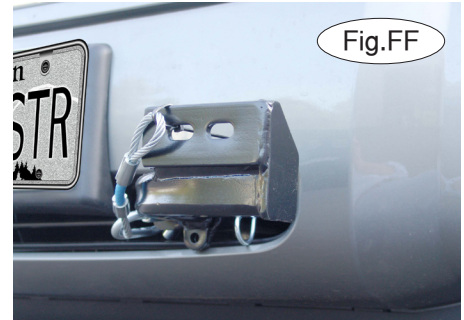

BOLT TORQUE REQUIREMENTS

Note: The torque values represented below are intended as general guidelines. Torque requirements for specific applications may vary. Roadmaster does not warrant this information to be accurate for all applications and disclaims all liability for any claims or damages which may result from its use.

STANDARD BOLTS

Thread Size	Grade	Torque
5/16.....	5.....	13 ft./lb.
3/8.....	5.....	23 ft./lb.
7/16.....	5.....	37 ft./lb.
1/2.....	5.....	56 ft./lb.
5/8.....	5.....	140 ft./lb.

METRIC BOLTS

Thread Size	Grade	Plated / Unplated
8mm-1.0	8.8	20 ft./lb. 18 ft./lb.
8mm-1.25	8.8	19 ft./lb. 18 ft./lb.
10mm-1.25	8.8	38 ft./lb. 36 ft./lb.
10mm-1.5	8.8	37 ft./lb. 35 ft./lb.

METRIC BOLTS

Thread Size	Grade	Plated / Unplated
12mm-1.25	8.8	70 ft./lb. 65 ft./lb.
12mm-1.5	8.8	66 ft./lb. 61 ft./lb.
12mm-1.75	8.8	65 ft./lb. 60 ft./lb.
14mm-2.0	8.8	104 ft./lb. 97 ft./lb.

All illustrations and specifications contained herein are based on the latest information available at the time of publication approval. ROADMASTER, INC. reserves the right to make changes at any time without notice in material, specification and models or to discontinue models.