



MOUNTING BRACKET KIT INSTALLATION INSTRUCTIONS

KIT# 52285-1

08/22/14
KS

ROADMASTER, Inc. 6110 NE 127th Ave. Vancouver, WA 98682 360-896-0407 fax 360-735-9300 www.roadmasterinc.com

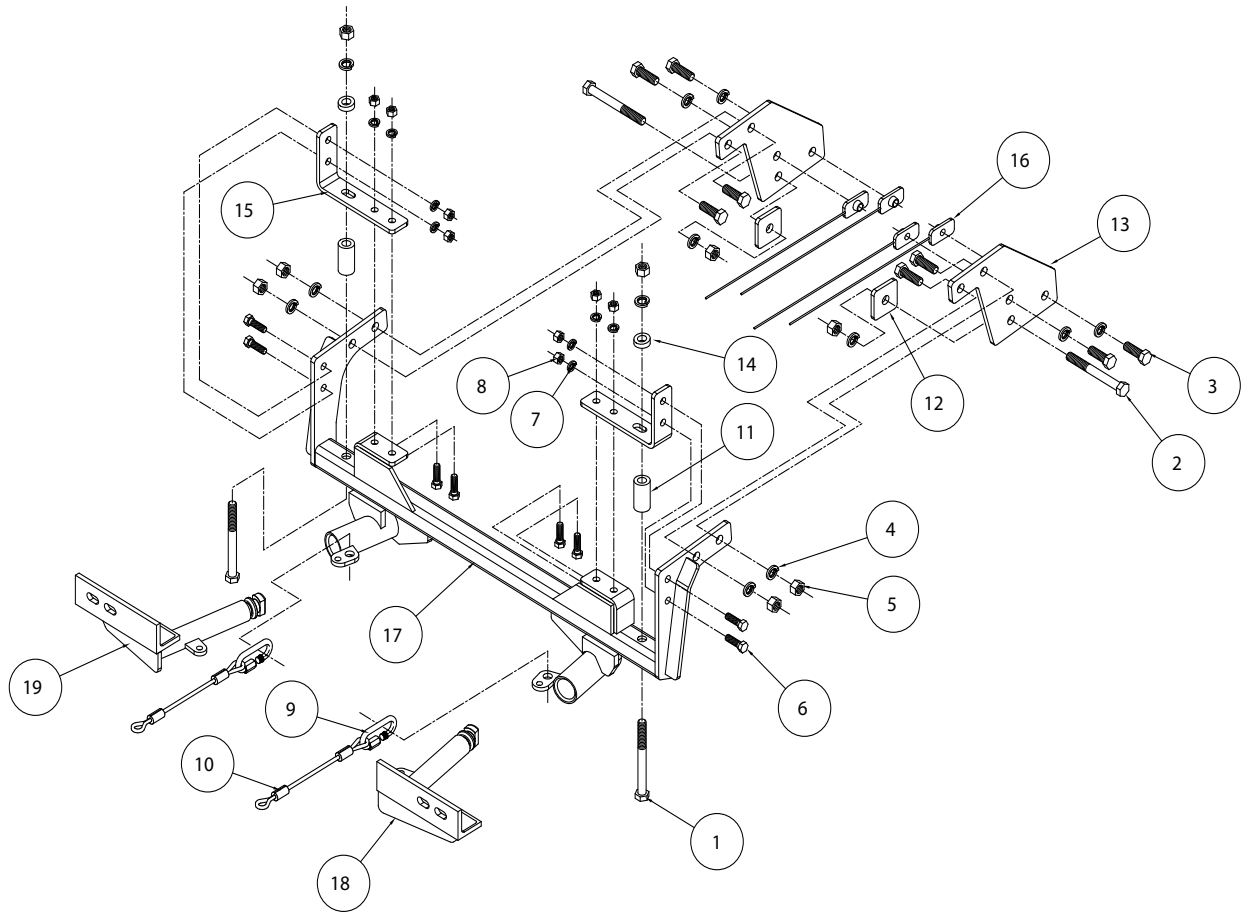

ITEM	QTY	NAME	MATERIAL
1	2	1/2" x 5" BOLT	350107-00
2	2	1/2" x 4 1/2" BOLT	350106-00
3	8	1/2" x 1 1/2" BOLT	350095-00
4	12	1/2" LOCK WASHER	350309-00
5	8	1/2" HEX NUT	350258-00
6	8	3/8" x 1 1/4" BOLT	350056-00
7	8	3/8" LOCK WASHER	350305-00
8	8	3/8" HEX NUTS	350254-00
9	2	QUICK LINK	200008-00
10	2	SAFETY CABLE 10"	500646-10
11	2	1" O.D. x 0.219 WALL x 2" PIPE SPACER	A-001056
12	2	1/4" x 2" x 2" ROUND HOLE BACKING PLATE	A-001066
13	2	SIDE PLATE	A-002587
14	2	1" O.D. x 0.219 WALL x 3/8" 6 DEGREE PIPE SPACER	A-002588
15	2	UPPER BRACE	B-001144
16	4	1/4" x 1" x 2" THREADED BACKING PLATE W/ ROD	C-002439
17	1	MAIN RECEIVER	C-001653
18	1	DRIVER SIDE ARM	C-001654
19	1	PASSENGER SIDE ARM	C-001655



MOUNTING BRACKET KIT INSTALLATION INSTRUCTIONS

KIT# 52285-1

08/22/14
KS

ROADMASTER, Inc. 6110 NE 127th Ave. Vancouver, WA 98682 360-896-0407 fax 360-735-9300 www.roadmasterinc.com

This is one of our EZ2 series brackets, which allows the visible front portion of the bracket to be easily removed from the front of the vehicle (Fig.A and Fig.B). The bracket consists of a main receiver brace, two removable front braces, two center braces and a hardware pack.

The main receiver brace mounts to the frame rails and the bumper core. The removable front braces install in the main receiver brace.

Before starting the installation, lay out the kit components in order, as they will be used. This will give you a visual idea of how the components work, and will also confirm that everything is present and accounted for.



Fig.A



Fig.B

IMPORTANT: All brackets *must* be assembled with all the bolts left loose for final adjustment and positioning (before tightening) unless otherwise instructed. All bolts *must* be torqued for proper strength. If more than one bolt is used per fastening point, the diagram may only show one.

- Use flat washers over all slotted holes
- Use lock washers on all fasteners

ROADMASTER Limited Warranty, including One-Year Conditional Warranty Text and Product Registration Card, in Carton.

WARNING

Failure to follow these instructions can result in property damage, personal injury or even death.

- **Installation of most mounting brackets requires moderate mechanical aptitude and skills.** We strongly recommend professional installation by an experienced installer.
- **The installer must read the instructions and use all bolts and parts supplied.** Failure to do so could result in loss of the towed vehicle.
- **Use Loctite® Red** on all bolts used for mounting this bracket.
- **Every 3,000 miles, the owner must inspect the fasteners** for proper torque, according to the bolt torque requirements chart on the last page of these instructions. **The owner must also inspect all mounts and brackets for cracks or other signs of fatigue every 3,000 miles.** Failure to do so could result in loss of the towed vehicle.
- **The owner must check the vehicle manufacturer's instructions for the proper procedure(s) to prepare the vehicle for towing.** Some vehicles must be equipped with a transmission lube pump, an axle disconnect, driveline disconnect or free-wheeling hubs before they can be towed. Failure to properly equip the vehicle will cause severe damage to the transmission.
- **If running changes were made** by the vehicle manufacturer after this bracket was designed, some bolts or other fasteners in the hardware pack may no longer be the correct size. **It is the installer's responsibility** to verify that the bracket is securely fastened to the vehicle and fitted with the correct hardware to account for these changes. Failure to securely fasten the bracket could result in loss of the towed vehicle.
- **If the towed vehicle has been in an accident, it must be properly repaired before attaching the bracket. Do not install the bracket if any structural frame damage is found.** Failure to repair the damage could result in the loss of the towed vehicle.
- Roadmaster manufactures many styles of brackets. **If your bracket has removable arms, they must be removed before driving the vehicle, unless the arms can be pinned or padlocked in place.** If not secured, the arms could vibrate out, resulting in non-warranty damage or personal injury.
- Some motorhome chassis have such a tight turning radius that you can damage your motorhome, towed vehicle, tow bar or bracket while turning sharply. **Before getting on the road, test your turning radius in an empty parking lot.** Turning too sharply could result in non-warranty damage to towing system, motorhome and/or towed vehicle.
- **Do not back up with the towed vehicle attached** or non-warranty damage will occur to your towing system, motorhome and/or towed vehicle.
- **The safety cables must connect the towing vehicle to the towed vehicle frame to frame, with the cables crossed, with enough slack for sharp turns.** Refer to the cable instructions for proper routing. Failure to leave enough slack in the safety cables, or failure to connect the safety cables frame to frame, will result in the loss of the towed vehicle.
- This bracket is designed for use with ROADMASTER tow bars and ROADMASTER adaptors only. **Using this bracket with other brands, without an approved ROADMASTER adaptor, may result in non-warranty damage or injury.**
- **Do not use this document for custom fabrication,** as it may not show all parts or structural components. Custom fabrication or an attempt to copy this bracket design could result in loss of the towed vehicle.
- Upon final installation, **the installer must inspect the bracket to ensure adequate clearance, particularly around hoses, air conditioner lines, radiators, etc.,** or non-warranty damage to the towed vehicle will result.
- **This bracket is only warranted for the original installation.** Installing a used bracket on another vehicle is not recommended and will void the warranty.



MOUNTING BRACKET KIT INSTALLATION INSTRUCTIONS

KIT# 52285-1

08/22/14
KS

ROADMASTER, Inc. 6110 NE 127th Ave. Vancouver, WA 98682 360-896-0407 fax 360-735-9300 www.roadmasterinc.com

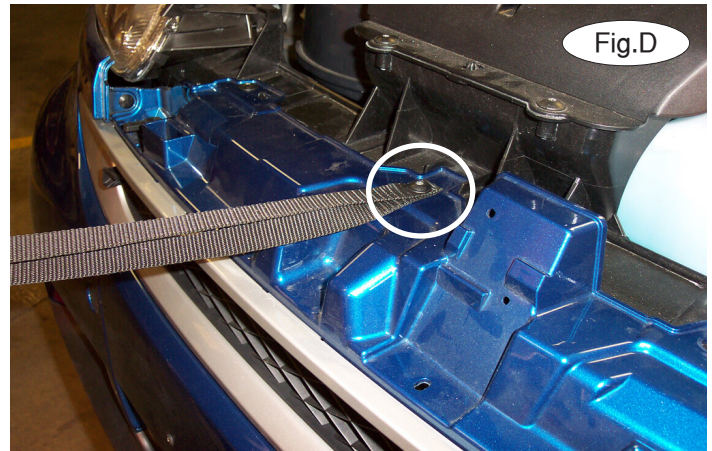

1. **Important:** please use all supplied bolts and parts and read all instructions carefully before beginning this installation. The majority of questions you may have can be answered within the text, and proper installation will ensure safe and secure travel. Now, begin the installation by releasing the two hood latches (Fig.C).

2. Lift the hood and remove the T25 Torx bolt holding the hood safety strap (Fig.D).



3. On each side, remove one plastic push fastener located near the inside corner of the headlight (Fig.E).

4. On each side, remove two T25 Torx bolts attaching the top of the fascia to the core support (Fig.F). *Note:* one is located near the inside of the headlight and one is located near the upper corner of the headlight.

5. Remove the antenna by unscrewing it counterclockwise (Fig.G).

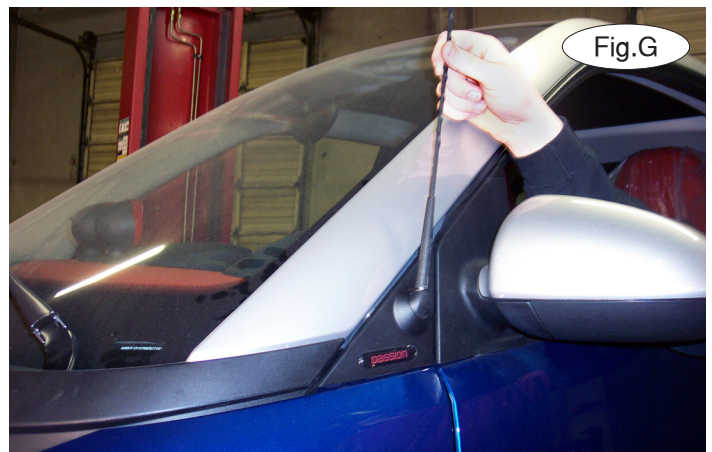



MOUNTING BRACKET KIT INSTALLATION INSTRUCTIONS

KIT# 52285-1

08/22/14
KS

ROADMASTER, Inc. 6110 NE 127th Ave. Vancouver, WA 98682 360-896-0407 fax 360-735-9300 www.roadmasterinc.com

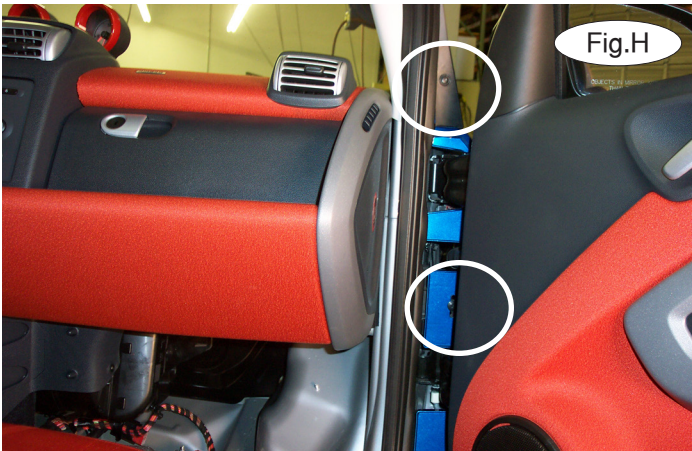

6. On each side, remove one T25 Torx plastic fastener and a plastic push fastener located on the inside edge of the door jamb (Fig.H). *Note:* the T25 Torx plastic fastener is located at the top, and the push fastener is in the middle.

7. On each side, pull out and up on the plastic cover at the top corner of the fascia to remove it (Fig.I).



8. Remove the T25 and T27 Torx bolts located behind the cover (Fig.J). *Note:* the T27 Torx bolt is the one toward the rear of the vehicle.

9. On each side, remove two plastic push fasteners attaching the rear of the lower rocker panel cover to the rear fender liner (Fig.K).

10. On each side, pull out on the bottom and the rear of the rocker panel cover and slide it back to unclip it (Fig.L). *Note:* if the car is on a lift, it must be lowered to the ground before the rocker panel covers can be removed.

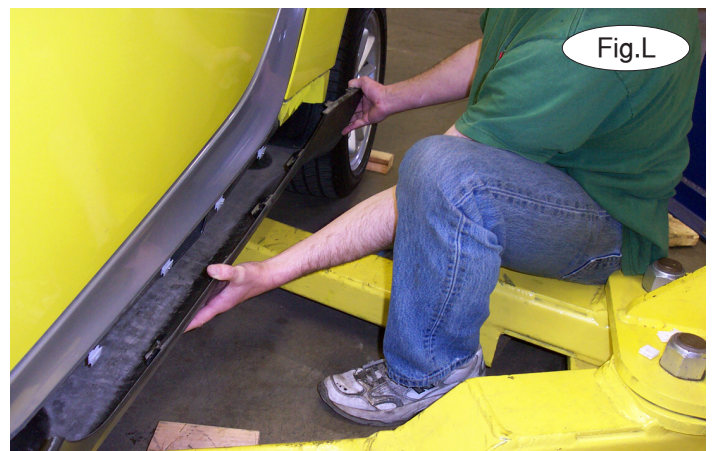



MOUNTING BRACKET KIT INSTALLATION INSTRUCTIONS

KIT# 52285-1

08/22/14
KS

ROADMASTER, Inc. 6110 NE 127th Ave. Vancouver, WA 98682 360-896-0407 fax 360-735-9300 www.roadmasterinc.com



11. On each side, remove one T25 Torx bolt attaching the lower rear corner of the fascia to the rocker panel (Fig.M).
12. Pull down to remove the two plastic clips attaching the lower front of the fascia to the splash shield (Fig.N).

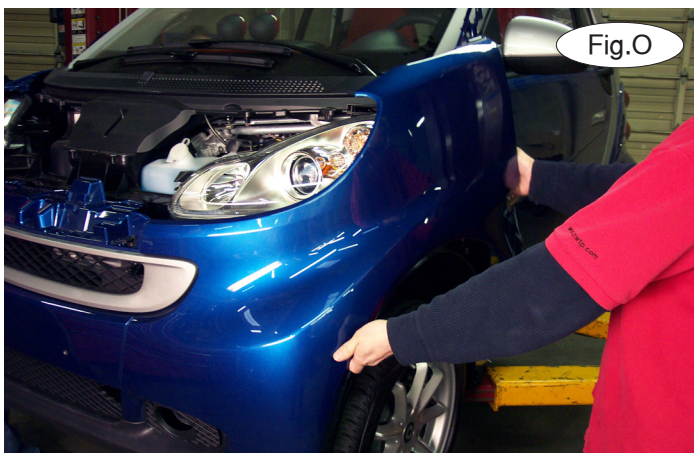

13. Pull out and forward on the rear of the fascia to lift it off the car. Before lifting it off completely, disconnect the side marker lights. *Note:* it is recommended that two people lift the fascia (Fig.O).
14. On each side, remove the three 15mm lug nuts on the front wheel of the vehicle. Remove the wheels (Fig.P).
15. On each side, remove the two plastic push fasteners attaching the fender liner to the core support (Fig.Q).

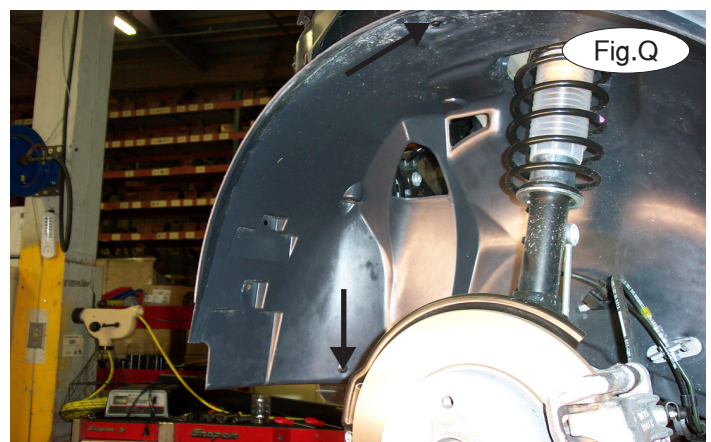



MOUNTING BRACKET KIT INSTALLATION INSTRUCTIONS

KIT# 52285-1

08/22/14
KS

ROADMASTER, Inc. 6110 NE 127th Ave. Vancouver, WA 98682 360-896-0407 fax 360-735-9300 www.roadmasterinc.com

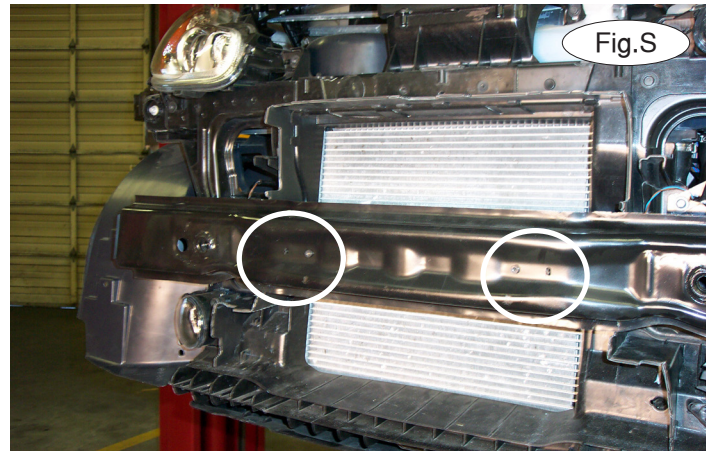

16. Remove the ABS wiring harness from the plastic retainer and unscrew the retainer counterclockwise (Fig.R).

17. Remove the two air bag sensors from the center of the bumper core by removing two T25 Torx bolts (Fig.S). *Note:* do not unplug the air bag sensors – if the ignition is turned on while the sensors are unplugged, the air bag sensor light will be triggered and will need to be reset by the dealer.

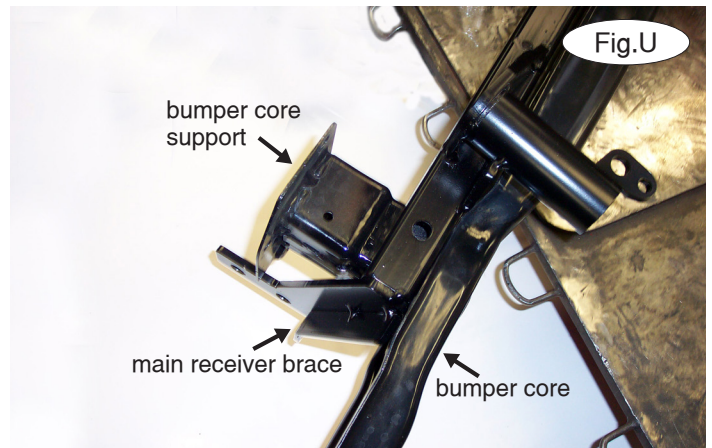
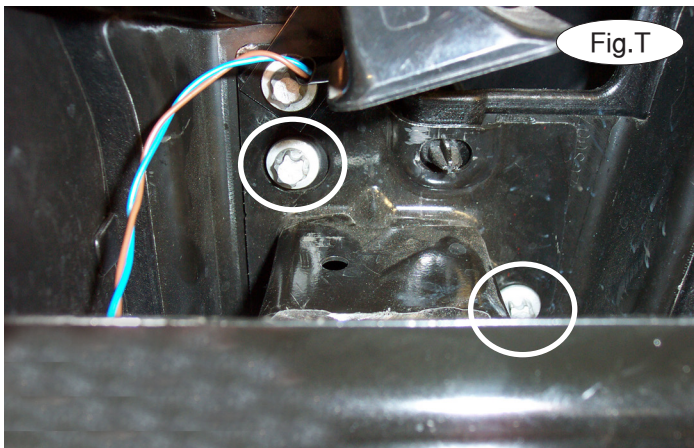

18. On each side, using a 6 point, 12mm socket, remove three bolts attaching the bumper core to the end of the frame rail (Fig.T). *Note:* only two are shown in Figure T. The third is below the bumper core support.

19. Place the bumper core upside down on a workbench area. Place the main receiver brace over the top of the bumper core supports. Slide it forward until the main receiver brace contacts the rear of the bumper core (Fig.U). *Note:* when the main receiver brace is clamped to the bumper core, only the lower end of the side mounting points should be touching the rear of the bumper core. There should be approximately a 1/2" gap at the top (Fig.V).

Clamp the main receiver brace to the bumper core supports and clamp both to a workbench. Using a 1/2" drill bit, and the pre-existing holes in the main receiver brace as templates, drill through both sides of the bumper core on each side (Fig.W – next page).

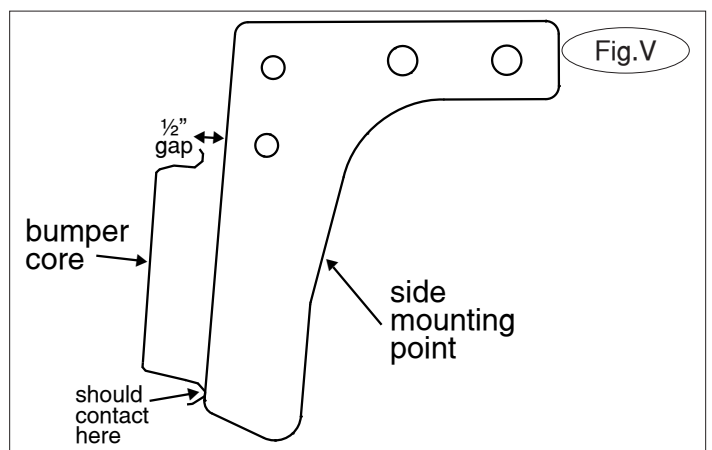



MOUNTING BRACKET KIT INSTALLATION INSTRUCTIONS

KIT# 52285-1

08/22/14
KS

ROADMASTER, Inc. 6110 NE 127th Ave. Vancouver, WA 98682 360-896-0407 fax 360-735-9300 www.roadmasterinc.com

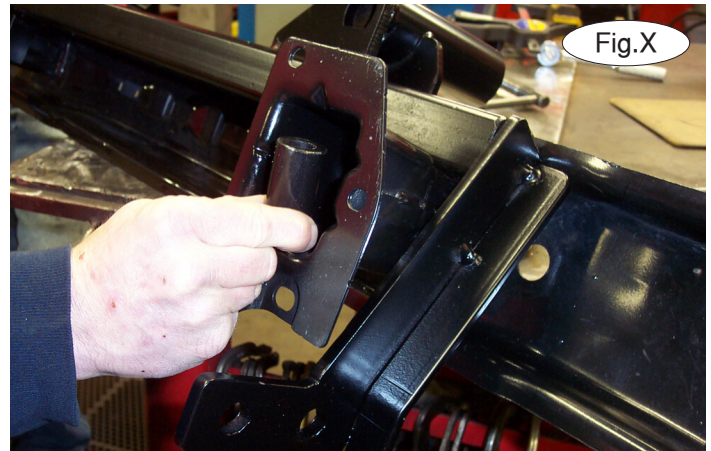
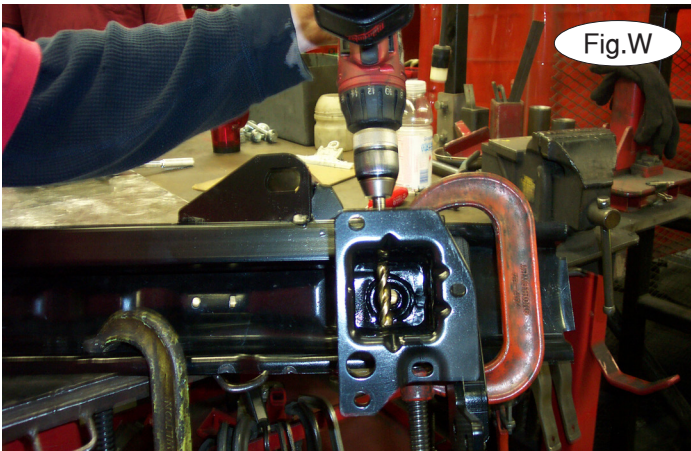

20. Place a 1" x 2" pipe spacer inside the bumper core (Fig.X). Bolt through the main receiver brace, bumper core support and the pipe spacer using a 1/2" x 5" bolt.

Place the center brace over the 1/2" x 5" bolt. Place the 3/8" beveled spacer over it and bolt it into place using a 1/2" lock washer and nut. Bolt the center brace to the main receiver brace using four 3/8" x 1 1/4" bolts, lock washers and nuts. Repeat for the other side of the vehicle. *Note:* rotate the beveled spacer so the lock washer sits flat against it (Fig.Y). Tighten all bolts to the bolt torque requirements found at the end of this document.

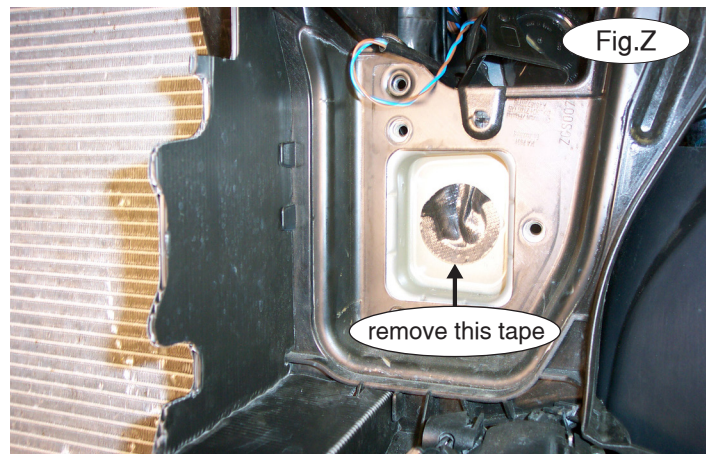
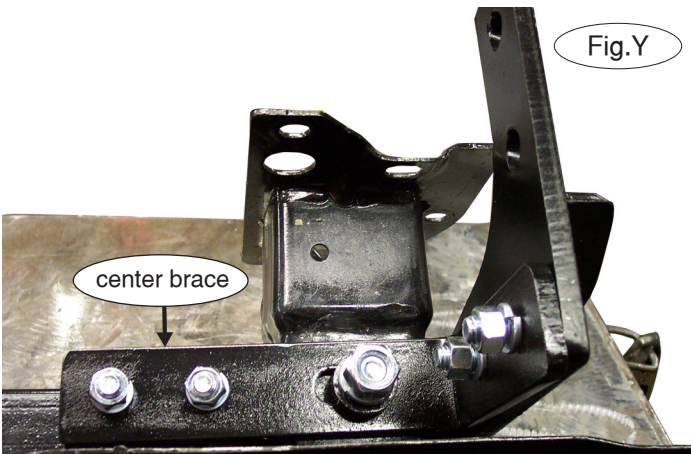

21. On each side, temporarily remove a piece of tape covering the opening in the end of the frame rail (Fig.Z).

22. On each side, pull back the fender liner and secure it with wire to gain access to the side of the frame rail (Fig. AA).





MOUNTING BRACKET KIT INSTALLATION INSTRUCTIONS

KIT# 52285-1

08/22/14
KS

ROADMASTER, Inc. 6110 NE 127th Ave. Vancouver, WA 98682 360-896-0407 fax 360-735-9300 www.roadmasterinc.com

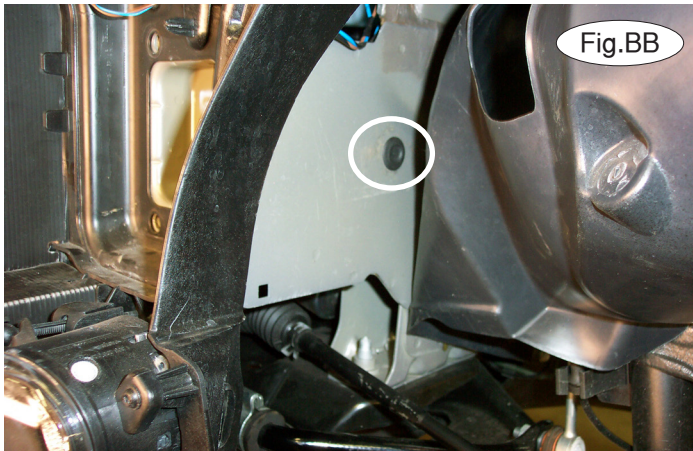

23. On each side, remove the rubber plug in the side of the frame rail (Fig.BB).

24. Position the rear mounting plate against the side of the frame rail so the two upper mounting points fall through the opening in the front of the core support. Place a $\frac{1}{2}$ " lock washer over a $\frac{1}{2}$ " x $1\frac{1}{2}$ " bolt, and place a $\frac{1}{4}$ " x 1" x 2" backing plate with wire through the opening in the front of the frame rail. Thread the $\frac{1}{2}$ " x $1\frac{1}{2}$ " bolt into the backing plate (Fig.CC).

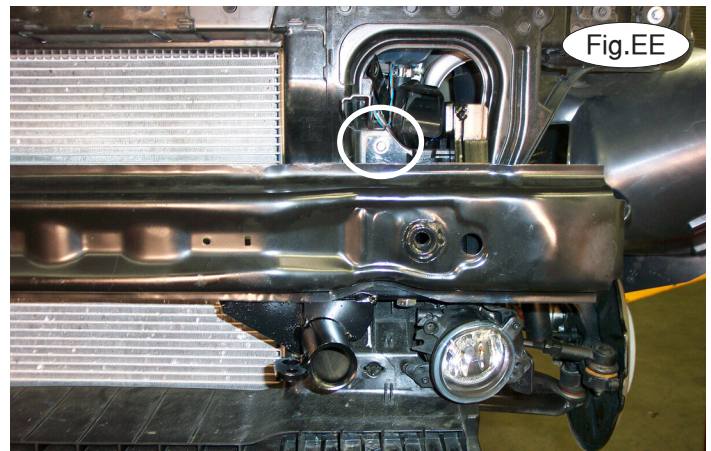
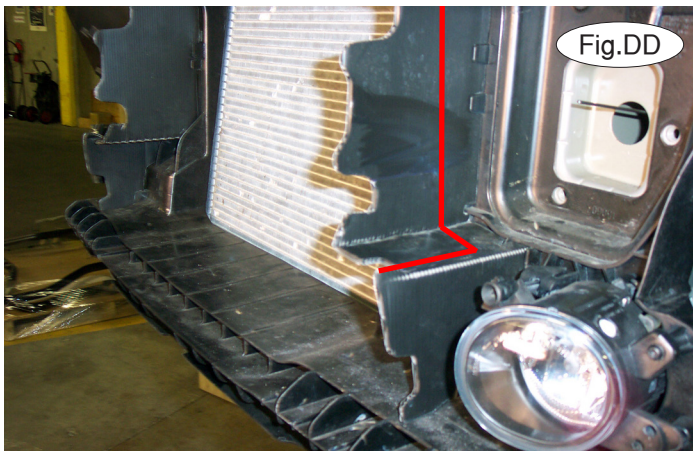

25. Trim the air deflector on each side using the red lines in Figure DD as a guide.

26. Place the bumper core and main receiver brace over the ends of the frame rails. On each side, replace the top 10mm (head) bumper core bolt, and tighten (Fig.EE – driver's side).

27. Bolt the main receiver brace to the rear brace using $\frac{1}{2}$ " x $1\frac{1}{2}$ " bolts, lock washers and nuts (Fig.FF).

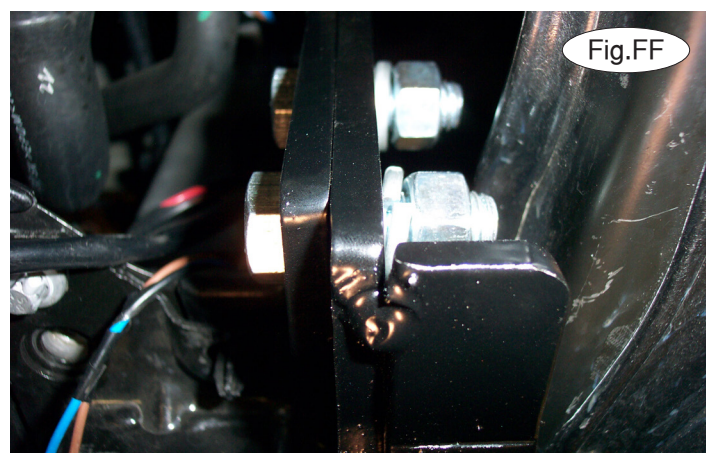



MOUNTING BRACKET KIT INSTALLATION INSTRUCTIONS

KIT# 52285-1

08/22/14
KS

ROADMASTER, Inc. 6110 NE 127th Ave. Vancouver, WA 98682 360-896-0407 fax 360-735-9300 www.roadmasterinc.com

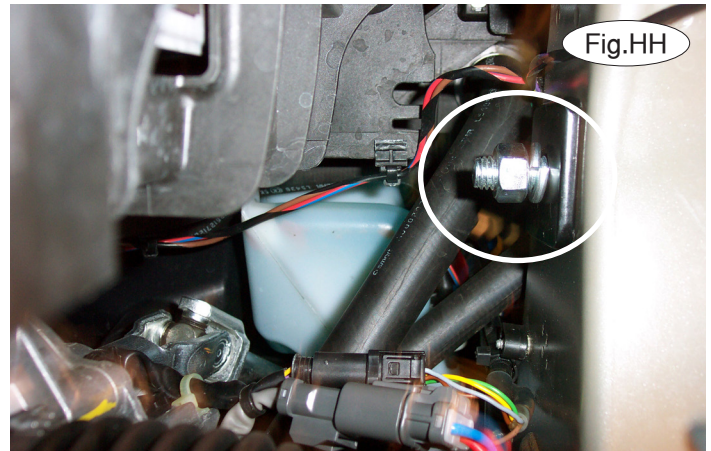

28. Working on the driver's side only, and using the lower pre-existing hole in the rear brace as a template, drill a $\frac{1}{2}$ " hole through both sides of the frame rail. Use the upper pre-existing hole in the rear brace as a template and drill a $\frac{1}{2}$ " hole through the outside of the frame rail only (Fig.GG).

29. Place a $\frac{1}{2}$ " x $4\frac{1}{2}$ " bolt through the rear brace, frame rail and a $\frac{1}{4}$ " x 2" x 2" backing plate. Finish with a $\frac{1}{2}$ " lock washer and nut (Fig.HH). Repeat steps 28 and 29 for the passenger side.

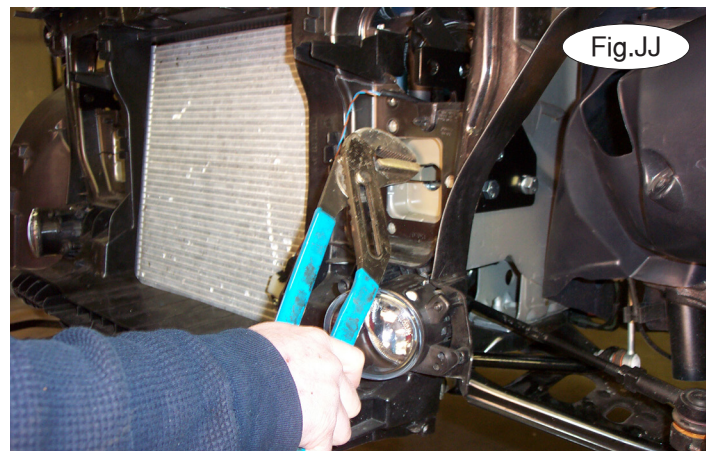

30. Remove four $\frac{1}{2}$ " x $1\frac{1}{2}$ " bolts attaching the main receiver brace to the rear brace. Remove the upper 10mm (head) bolt attaching the bumper core to the frame rail.

31. Place a $\frac{1}{4}$ " x 1" x 2" backing plate in the frame rail. Bolt through the upper rear mounting point on the rear brace using a $\frac{1}{2}$ " x $1\frac{1}{2}$ " bolt and $\frac{1}{2}$ " lock washer (Fig.II).

32. Break the wire off the backing plates using a pair of pliers (Fig.JJ).

33. Reinstall the bumper core and replace the bolts attaching the main receiver brace to the rear braces. *Note:* replacing the bumper core bolts requires a universal extension. Tighten all bolts to the bolt torque requirements found at the end of this document.



MOUNTING BRACKET KIT INSTALLATION INSTRUCTIONS

KIT# 52285-1

08/22/14
KS

ROADMASTER, Inc. 6110 NE 127th Ave. Vancouver, WA 98682 360-896-0407 fax 360-735-9300 www.roadmasterinc.com

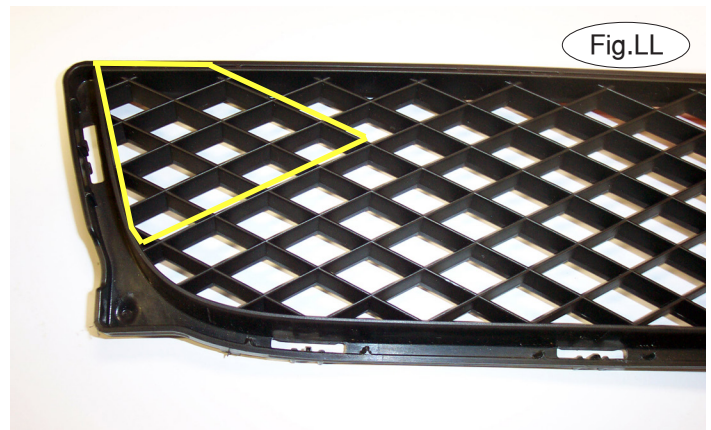

34. **For 2013 and later models:** trim the fascia using the yellow lines in Figure KK as a reference for trimming. **For all other models:** trim the grille using the yellow lines in Figure LL as a reference. Reinstall the trimmed grille (Fig.MM).

35. Reinstall the fascia, wheels, air bag and the air bag sensors by reversing steps 1 through 17. *Note:* to replace the rocker panel covers, unscrew the plastic fittings from the rocker panel and slide them into the mounting points on the rocker panel cover. Set the rocker panel cover in place, aligning the plastic fasteners over the studs, and lock each cover into place (Fig.NN).

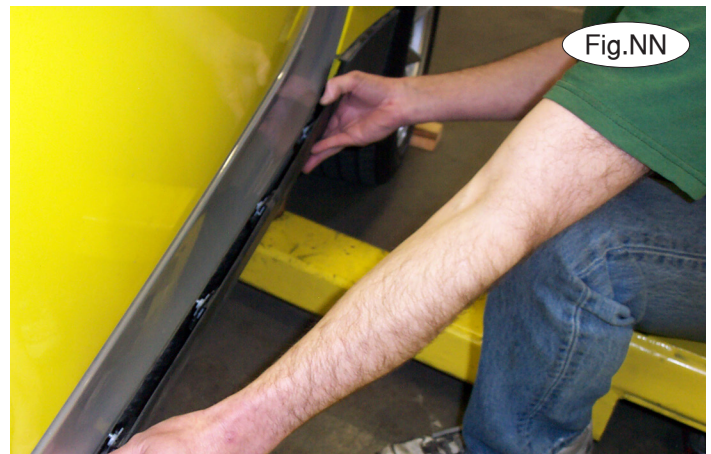

36. Torque all bolts to the bolt torque requirements found at the end of these instructions.

37. Insert the removable front bracket arms into the front receiver braces, and twist each one 90 degrees to lock.

38. Attach the 10" safety cables with the cable connectors (Q-Links) to the front of the receiver braces (Fig.OO).

39. Attach the ends of the safety cables to the tow vehicle's safety cables.

40. Install the tow bar to the mounting bracket according to the manufacturer's instructions.





MOUNTING BRACKET KIT INSTALLATION INSTRUCTIONS

KIT# 52285-1

08/22/14
KS

ROADMASTER, Inc. 6110 NE 127th Ave. Vancouver, WA 98682 360-896-0407 fax 360-735-9300 www.roadmasterinc.com

BOLT TORQUE REQUIREMENTS

Note: The torque values represented below are intended as general guidelines. Torque requirements for specific applications may vary. Roadmaster does not warrant this information to be accurate for all applications and disclaims all liability for any claims or damages which may result from its use.

STANDARD BOLTS

Thread Size	Grade	Torque
5/16.....	5.....	13 ft./lb.
3/8.....	5.....	23 ft./lb.
7/16.....	5.....	37 ft./lb.
1/2.....	5.....	56 ft./lb.
5/8.....	5.....	150 ft./lb.

METRIC BOLTS

Thread Size	Grade	Plated / Unplated
8mm-1.0.....	8.8.....	20 ft./lb. 18 ft./lb.
8mm-1.25.....	8.8.....	19 ft./lb. 18 ft./lb.
10mm-1.25.....	8.8.....	38 ft./lb. 36 ft./lb.
10mm-1.5.....	8.8.....	37 ft./lb. 35 ft./lb.

METRIC BOLTS

Thread Size	Grade	Plated / Unplated
12mm-1.25.....	8.8.....	70 ft./lb. 65 ft./lb.
12mm-1.5.....	8.8.....	66 ft./lb. 61 ft./lb.
12mm-1.75.....	8.8.....	65 ft./lb. 60 ft./lb.
14mm-2.0.....	8.8.....	104 ft./lb. 97 ft./lb.

All illustrations and specifications contained herein are based on the latest information available at the time of publication approval. ROADMASTER, INC. reserves the right to make changes at any time without notice in material, specification and models or to discontinue models.