



BX3232

2007 Pontiac Solstice (No Turbo) 2007 Saturn Sky Installation Instructions

Attachment Tab Height: 14"

Attachment Tab Width: 18"

Serial Number

Please read **BOTH** these Installation Instructions and the General Instructions prior to installing or operating this equipment.

- Blue Ox® towing products and accessories are intended to be installed by Blue Ox® Dealers who are familiar with our products and have the equipment and knowledge necessary to do "fit work". If needed, Blue Ox® Dealers can be found at www.blueox.com or by contacting our Customer Care Department at (402) 385-3051.
- Many Blue Ox® baseplates are designed to use existing holes and hardware to mount the baseplate to the towed vehicle. Even though bolts are there, do not assume they are adequate for baseplate mounting. Always use the hardware supplied in the hardware kit and existing hardware as specified in the installation instructions.

Bolt Torque Specifications

Torque in Foot-Pounds for Inch Bolts

Bolt Size	Grade 5	Grade 8
1/4"	10	14
5/16"	19	29
3/8"	33	47
7/16"	54	78
1/2"	78	119
5/8"	154	230
3/4"	257	380



If the front of your vehicle looks different than this, please contact us at (402)385-3051.

Reference your vehicle owner's manual for manufacturer's towing specifications.

Bolt Torque Specifications

Torque in Foot-Pounds for Metric Bolts

Bolt Size	Grade 8.8	Grade 10.9
6MM	6	8
8MM	16	22
10MM	31	40
12MM	54	70
14MM	89	117
16MM	161	230
18MM	222	318



WARNING

Failure to read and follow these instructions could result in separation of the towed vehicle from the tow bar, causing property damage, loss of towed vehicle, personal injury or death.

BX3232
2007 Pontiac Solstice
2007 Saturn Sky
Installation Instructions

Instruction Notes: The fascia and bumper are removed and reinstalled for the baseplate installation. Some drilling and trimming is required.

Place all components that are removed on a flat, sturdy surface. All items will be reinstalled unless otherwise noted after the baseplate is installed.

The dimensional variations between otherwise identical vehicles can be considerable. While the baseplate was designed for easy installation, it may be necessary to tailor the baseplate slightly to compensate for vehicle manufacturer's tolerances.

The BX8869 Tail Light Wiring Kit is recommended for this vehicle.



Drill a hole according to the tail
light wiring kit instructions.

NOTICE

- Handling of some cosmetic parts when installing this product may require the use of protective covers, rags, specialty tools, etc. to prevent damage.
- When using power drills be aware of the dangers of torque and drill bit length.
- When using a reciprocating saw be aware of objects behind the cutting surface.
- Use a good quality paint to spray cut edges of frame to prevent rusting.
- Be sure that **ALL** electrical connections are plugged in and accessories are functioning properly before reinstalling the fascia.
- **DO NOT** use the towed vehicle for storing luggage, equipment, etc. The baseplate is computer tested to your vehicle's GVWR, exceeding this weight will void the manufacturer's warranty.
- Be sure to use Loctite® Red on all bolts before tightening. Tighten all bolts according to the torque chart provided.
- Dealer or installer be certain the user receives these instruction sheet.
- If the baseplate is in an accident, it must be replaced. **DO NOT** use it again! An accident can cause unseen damage and using it again could result in more damage or serious injury. **DO NOT** use the baseplate if it is damaged or missing parts.

BX3232
2007 Pontiac Solstice
2007 Saturn Sky
Installation Instructions

Tools Required

Large Vise Grip
 Utility Knife
 Torque Wrench
 Drill
 Reciprocating Saw
 Tape Measure
 Loctite® RED
 13/32" Drill Bit
 6MM Socket
 7MM Socket
 10MM Socket
 13MM Socket
 7/16" Socket
 9/16" Socket

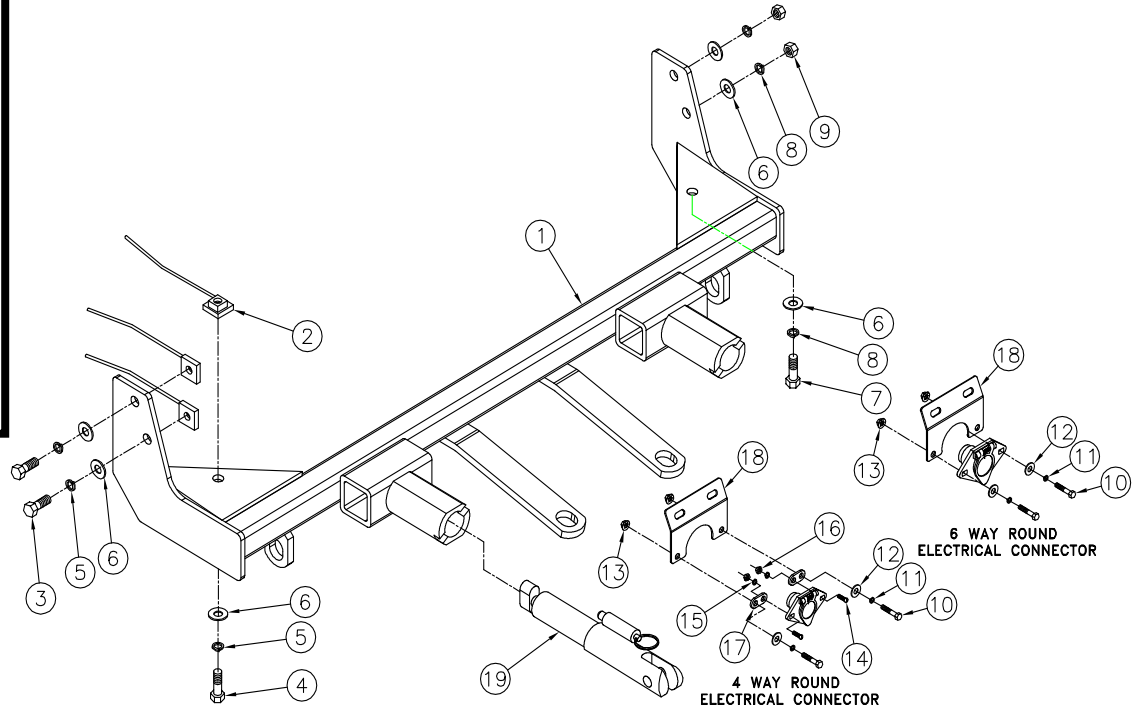

Item. No.	Qty.	Part #	Description
1	1	61-6428	WLDM'T, BASEPLATE, BX3232
2	3	61-5208	WLDT, NUT PLT, 1/4X1X1, 3/8 BLT WIR
3	2	201-0368	3/8-16 X 1 1/4 HEX HEAD BOLT,GRD. 5
4	1	201-0440	3/8-16 X 1 1/2 HEX BOLT, GRD.5, ZP
5	3	203-0010	3/8 LOCK WASHER, ZP
6	6	203-0003	3/8 FLAT WASHER, ZP
7	1	201-0410	10MM-1.5 X 35MM HEX BOLT GRD.8.8 ZP
8	3	203-0104	10MM LOCK WASHER, ZP.
9	2	202-0111	10MM-1.5 HEX NUT ZP
10	2	201-0448	1/4-20 X 1 1/2 HEX BOLT GRADE 5 ZP.
11	5	203-0008	1/4 LOCK WASHER, ZP
12	5	203-0001	1/4 FLAT WASHER, ZP
13	2	202-0069	1/4-20 HEX FLANGE WHIZ LOCK NUT, ZP
14	2	201-0192	10-32 X 1/2 SLOT, RD. HD. SCREW
15	2	203-0054	#10 LOCK WASHER
16	2	202-0047	#10-32 HEX NUT
17	2	101-5822	ADAPTER, 4 WAY CONNECTOR
18	1	101-6841	ELECTRICAL BRACKET, 45 DEGR.
19	2	62-3469	ATT TAB ASSY, REM, SF/LB, 1 HOLE
	2	226-004	BASEPLATE SAFETY CABLE, 48" CL III
	2	229-0359	QUICKLINK, 3/8, ZP
	2	290-0437	RECEIVER, CAP PLUG (BLK) (NOT SHOWN)

Important:

Use only genuine factory replacement parts on your baseplate. Do **NOT** substitute homemade or non-typical parts. If a bolt is lost or in need of replacement, for your safety and the preservation of your baseplate, be sure to use a replacement bolt of the same grade (In most cases it will be Grade 5, please reference the parts list above). Replacement parts may be ordered through your nearest Blue Ox® Dealer or Distributor. Failing to follow and/or altering these installation instructions in either installation or required equipment will void the manufacturer's warranty. Towing behind a non-motorized vehicle will void the warranty.

BX3232
2007 Pontiac Solstice
2007 Saturn Sky
Installation Instructions

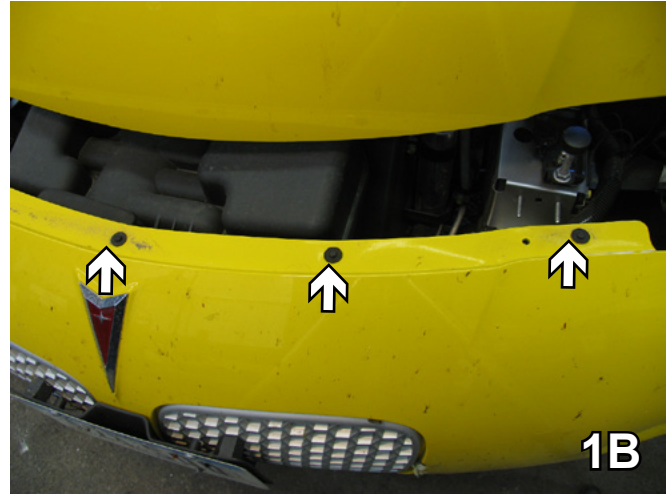

1. Using a 7MM socket remove the 9 hex bolts from the flat top edge of fascia starting with the two bolts above the tire and continuing around to the two bolts above the other tire. Set bolts aside to be reinstalled later.

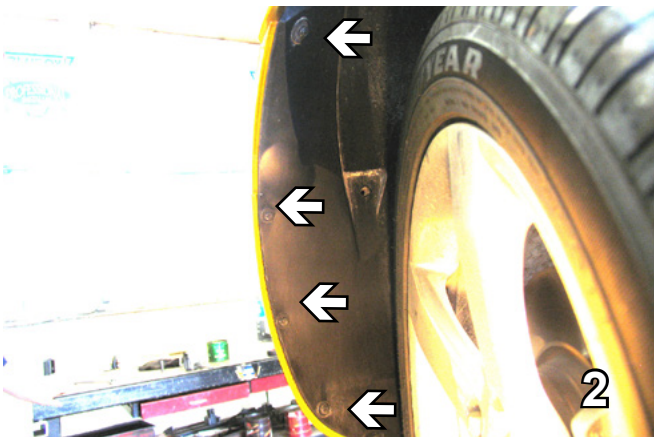

2. Using a 7MM socket, remove the 4 hex bolts just forward the front tire. Do this to both sides and set aside for later reinstallation.
3. Using a flat screwdriver, remove 3 push pins from up underneath. Set push pins aside to be reinstalled later. Do this to both sides of the vehicle.

BX3232
2007 Pontiac Solstice
2007 Saturn Sky
Installation Instructions

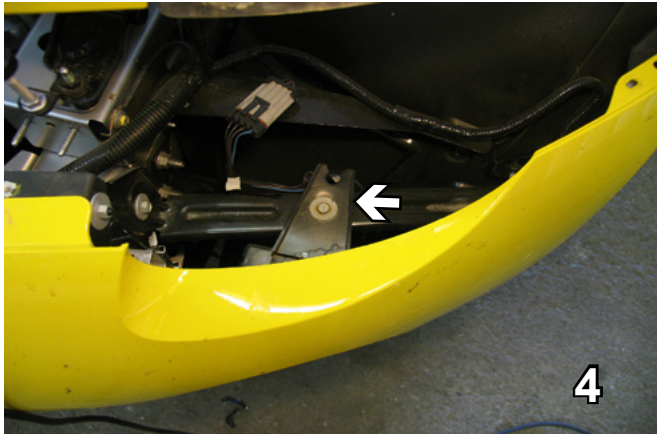

4. There is a bolt just below headlight assembly and behind fascia to be removed with a 10MM socket. Remove bolt and set aside for later reinstallation. Unhook the marker lights.

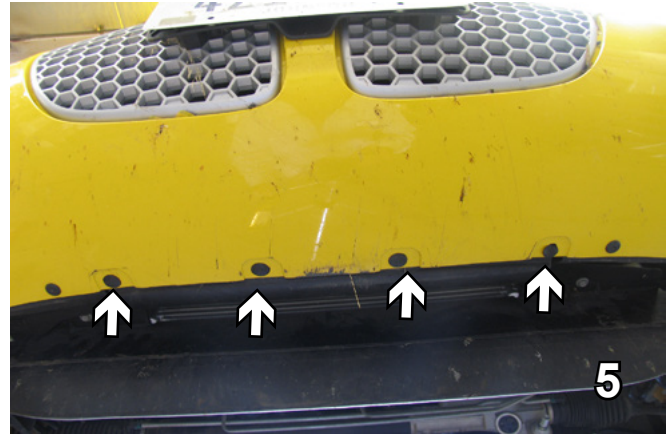

5. Using a flat screwdriver, remove the (4) push pins from the center of the fascia. Pull fascia corners out to the side of vehicle, then pull fascia forward and carefully set aside.

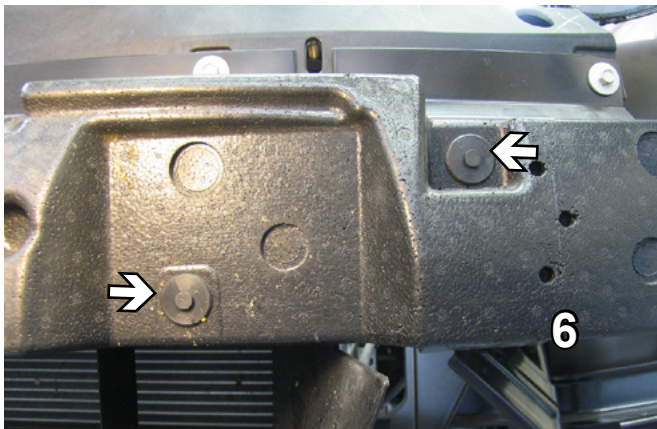

6. Remove the (2) push pins shown. Do this to both sides of the vehicle. Remove styrofoam from bumper.

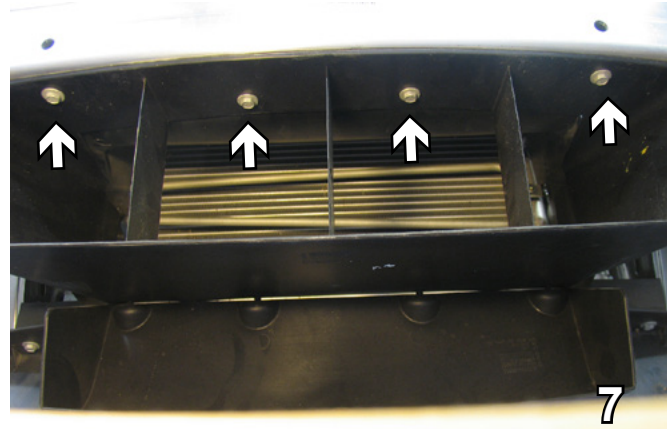

7. Using a 10 MM socket, remove the four bolts and the air dam from below the bumper. Set air dam for later reinstallation.

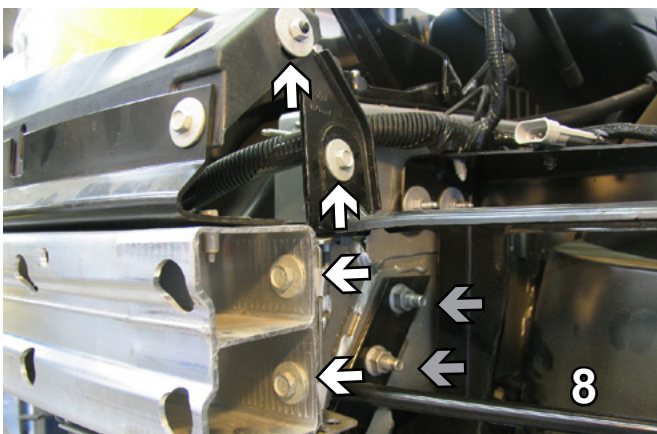

8. To remove the bumper, using a 10MM socket remove both top bolts. Then remove the bottom two bolts inside the bumper end using a 13MM socket. Using a 15MM socket, remove the back two hex nuts (grey arrows). Set aside bolts and nuts for later reinstallation.

BX3232
2007 Pontiac Solstice
2007 Saturn Sky
Installation Instructions

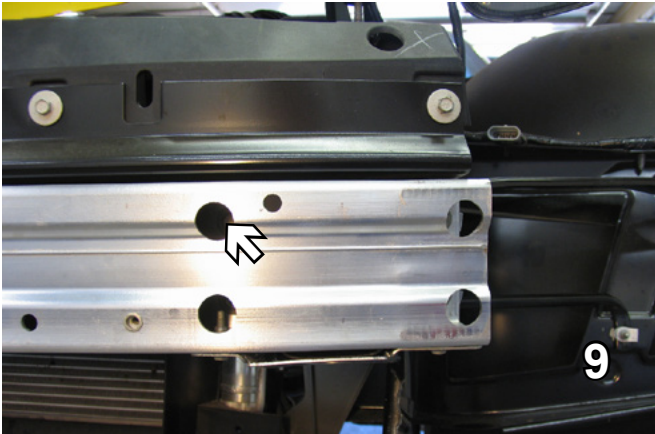

9. Using a 13MM socket, remove two more bolts from both sides. Set bolts aside to be reinstalled later.

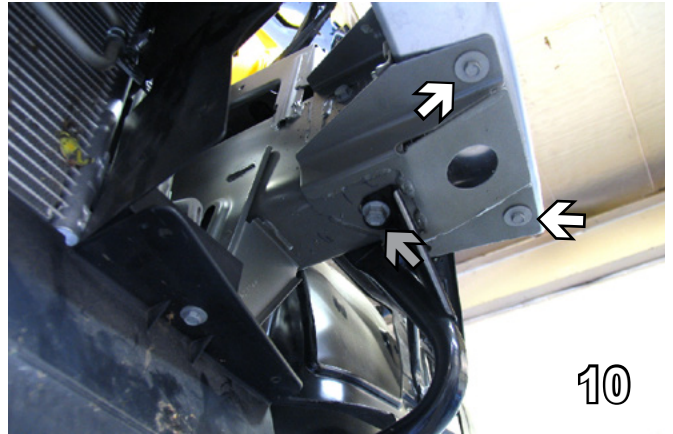

10. Remove three bolts underneath the bumper. Use a 10MM socket on the top two and a 15MM socket for the bottom one (grey arrow). Set aside bolts for later reinstallation.

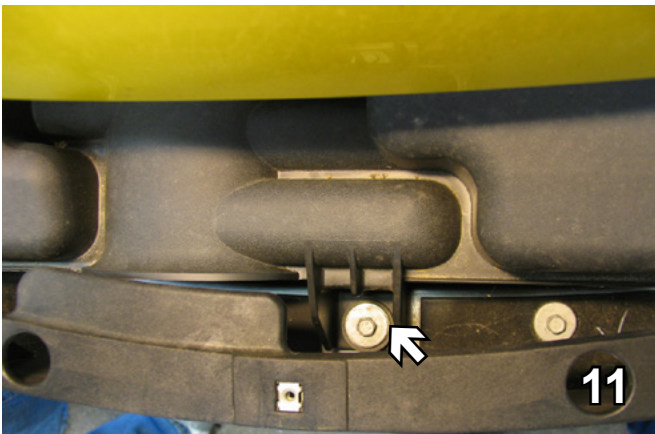

11. Up on top, remove one bolt using a 10MM socket. Set aside bolt for later reinstallation.

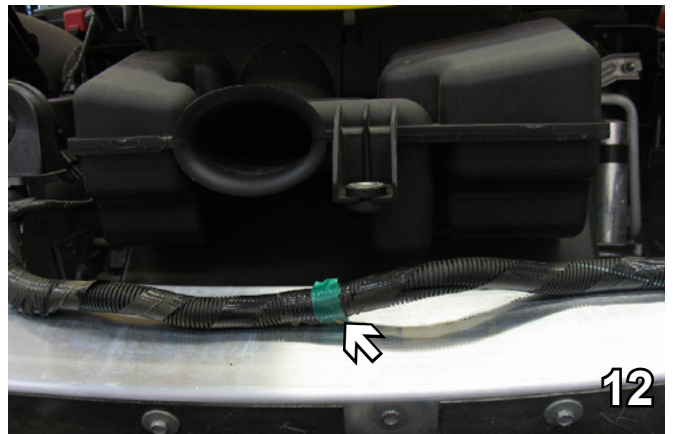

12. Remove three Christmas tree push pins before removing bumper. Set bumper and push pins aside for later installation.

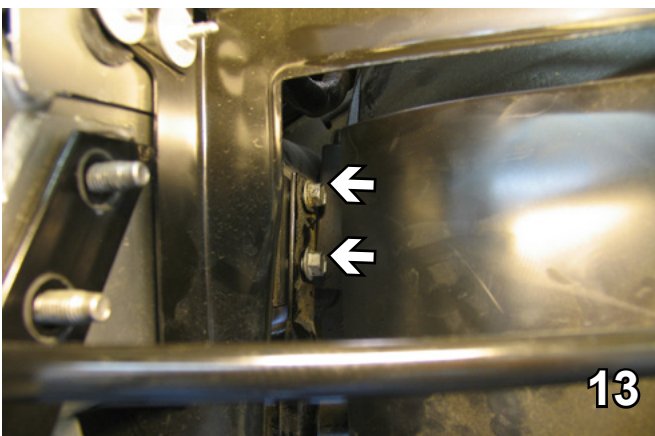

13. To remove support bar, remove 2 bolts behind fender well using a 15MM socket. This support bar will not be reinstallation.

BX3232
2007 Pontiac Solstice
2007 Saturn Sky
Installation Instructions

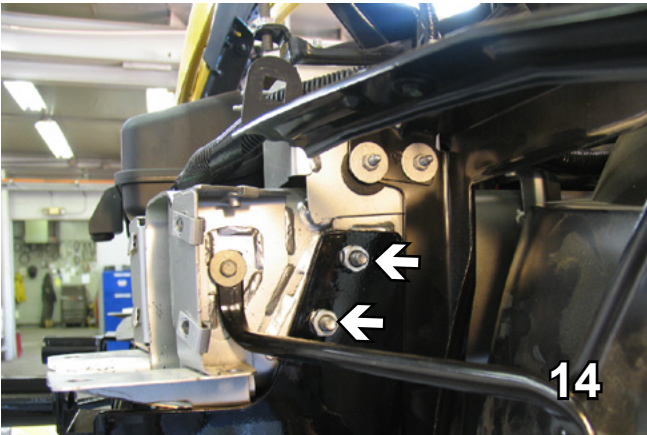

14. On the driver's side tip base plate so that hole starts on these two studs. Hand tighten the two 10M hex nuts and lock washers.

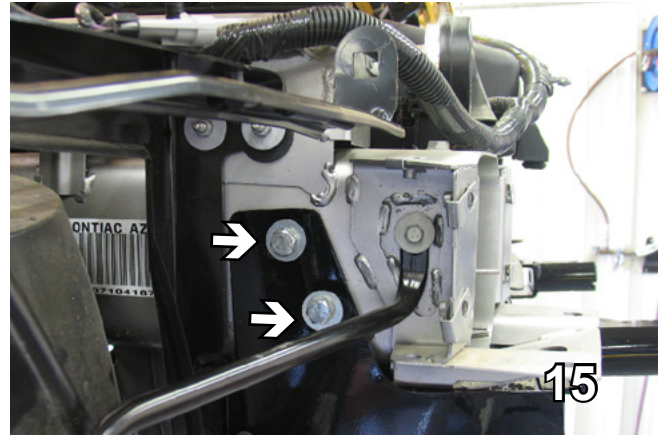

15. On the passenger side, hold the base plate level, up as far as possible and the same distance from the front as on the driver's side, mark holes and drill using a 13/32" drill bit. To attach base plate use two 3/8"-16 x 1 1/4" hex bolts with 3/8" lock and flat washers and 3/8" nut plates.

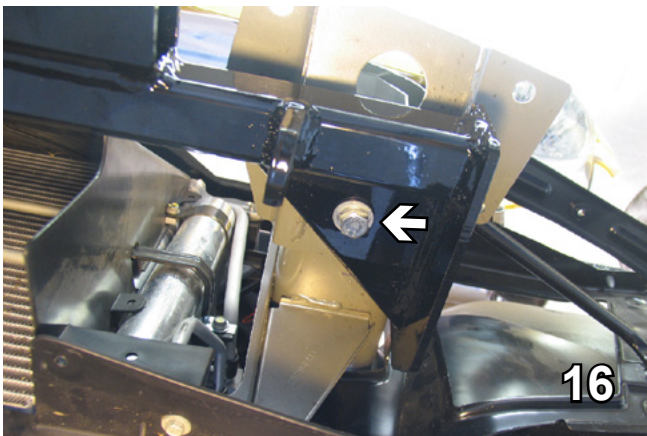

16. Make sure the base plate is straight. On the driver's side only, attach 10MM-1.5 x 35MM hex bolt with a 10MM lock washer and a 3/8" flat washer into existing threaded hole, tighten with Loctite Red.

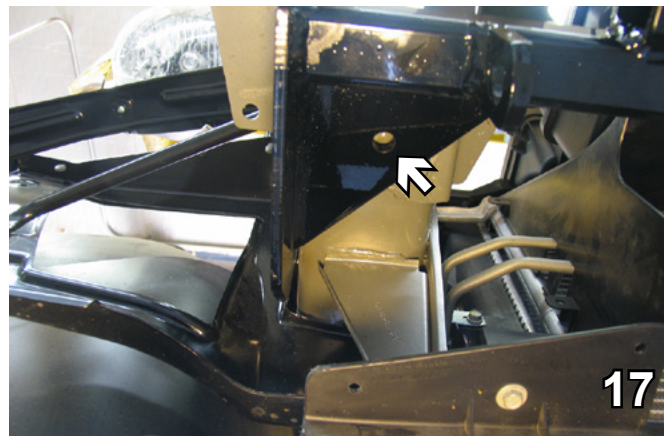

17. On the passenger side, use a 13/32" drill bit to drill a hole.

BX3232
2007 Pontiac Solstice
2007 Saturn Sky
Installation Instructions



18. Insert 3/8" nut plate into frame end to align with drilled hole and tighten 3/8"-16 x 1 1/2" hex bolt, 3/8" flat and lock washer.

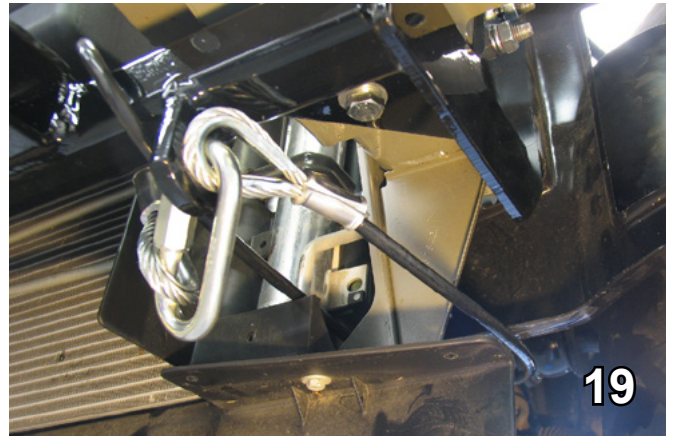

19. Attach the permanent baseplate safety cables to the provided convenience link on the baseplate. The photo above shows the recommended installation of the cables to frame of vehicle. Additional options may interfere with suggested mounting; in this case, secure the cables to a solid piece of the frame as described in the instructions included with the permanent baseplate safety cables. Be sure the safety cables do not rub against any hoses or moving parts. Do this on **BOTH** sides of the vehicle.

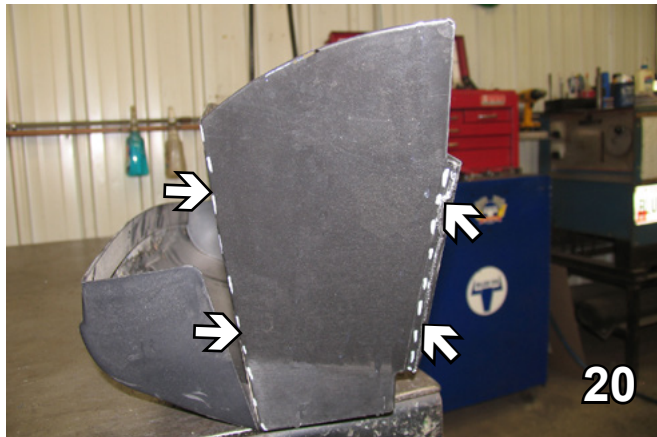

20. Using a utility knife, cut the ends off of the plastic air dam from below the bumper.

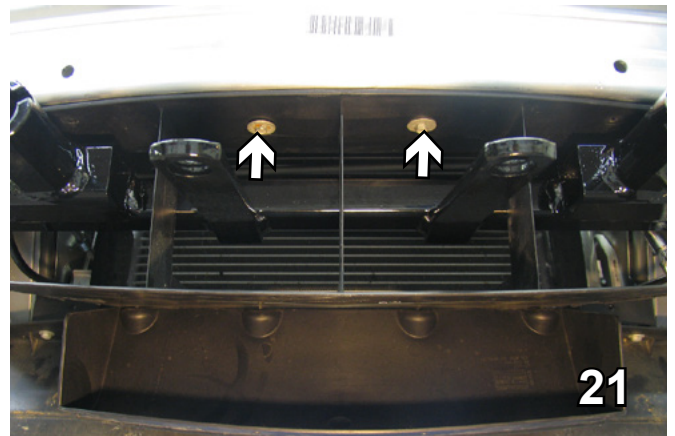

21. Reinstall bumper and air baffle over the top of the base plate. Attach with two center bolts.

BX3232
2007 Pontiac Solstice
2007 Saturn Sky
Installation Instructions



22. Hold fascia as close to its original position as possible and cut a hole in the grille with a hack saw blade for attachment tab receivers to come through. Do this to both sides. Then reinstall fascia.



23. Cut a hole in the grille for the electrical plug to go through. Place electrical connector bracket on the back side of the grille and attach with 1/4"-20 x 1 1/2" hex bolts, flat and lock washers and 1/4"-20 whiz nuts.

CUSTOMER SERVICE COMMITMENT

Blue Ox® is committed to providing you with exceptional customer care throughout your lifetime with our products. Our team is here to assist you with any questions you may have regarding the performance of your product. Simply call (402) 385-3051 and you can speak with our customer care team.

Additionally, please visit our website to see which rallies our Destination America team will be attending. For a nominal fee, our service technician will service your towing system to ensure it's in proper working condition. Also, as a commitment to our customers, should you visit our factory, you can stay at our full service Blue Ox® campground at no charge along with enjoying a factory tour.

Again, thank you for being our customer and for the confidence you have shown in the performance of our products. It is because of customers like you we enjoy the success we have today.

© 2013 Blue Ox
One Mill Road, Industrial Park
Pender, Nebraska 68047
Phone: (402) 385-3051
Fax: (402) 385-3360
www.blueox.com