

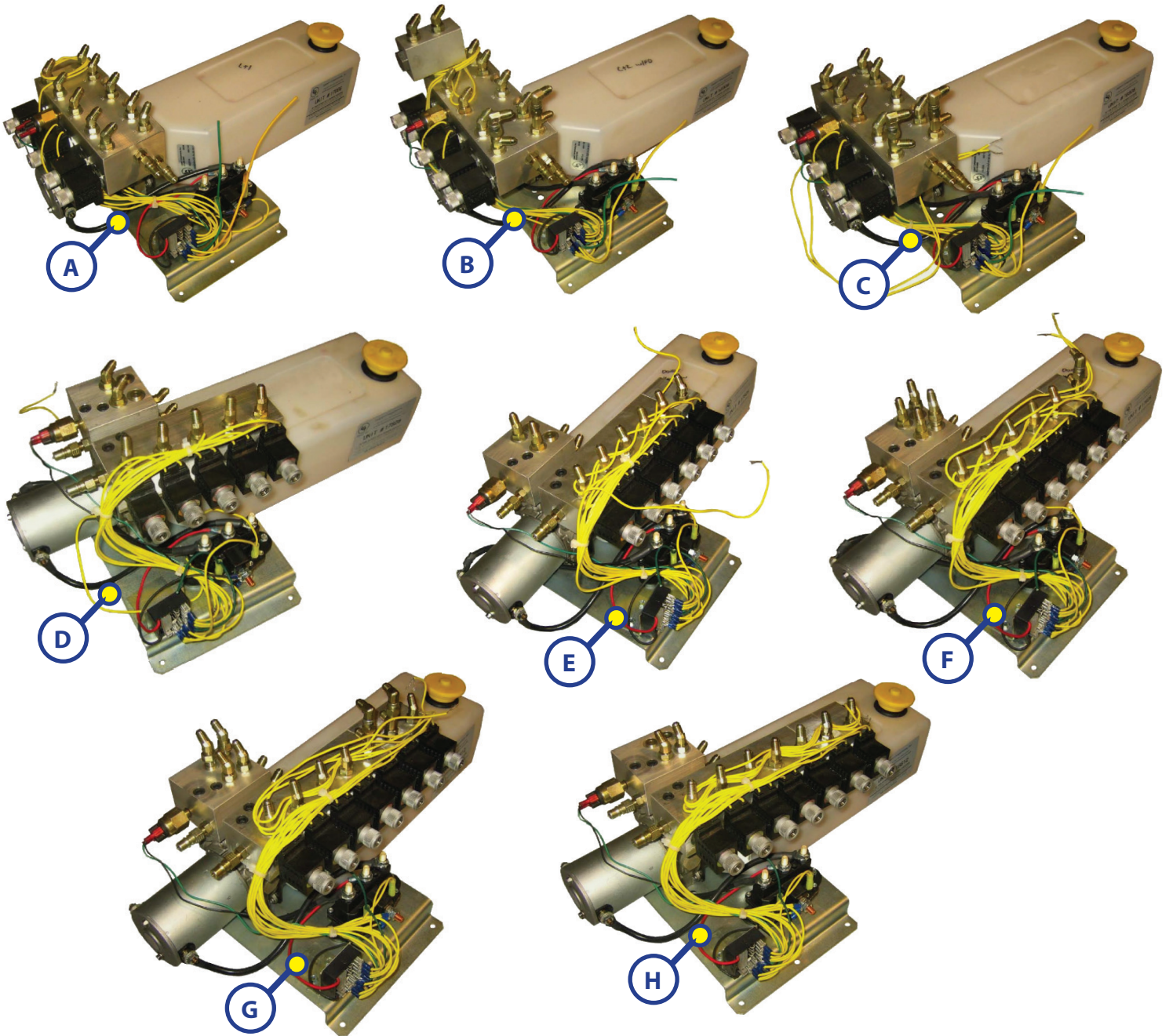

# MOTORIZED LEVELING BI-ROTATIONAL POWER UNIT COMPONENTS

## LEVELING & STABILIZATION



Callout	Part#	Description
A	146374	Leveling +1 Power Unit
B	146375	Leveling +2 Power Unit w/ Flow Divider
C	146376	Leveling +2 Power Unit
D	146377	Inline Leveling +1 Power Unit
E	146378	Inline Leveling +2 Power Unit
F	146379	Inline Leveling +2 Power Unit w/ Flow Divider
G	146380	Inline Leveling +3 Power Unit w/ Flow Divider
H	146381	Inline Leveling +3 Power Unit



# MOTORIZED LEVELING BI-ROTATIONAL POWER UNIT COMPONENTS

## LEVELING & STABILIZATION

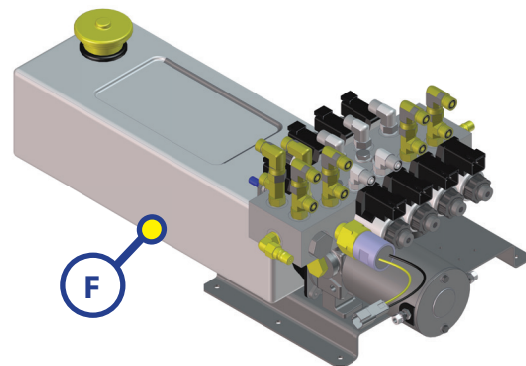
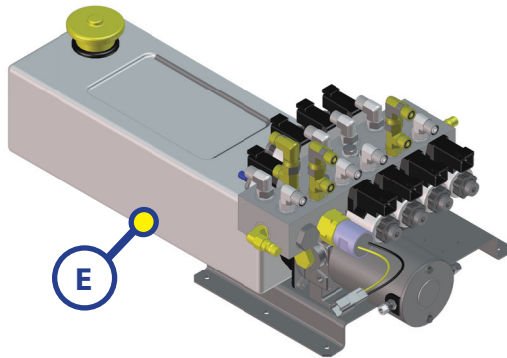
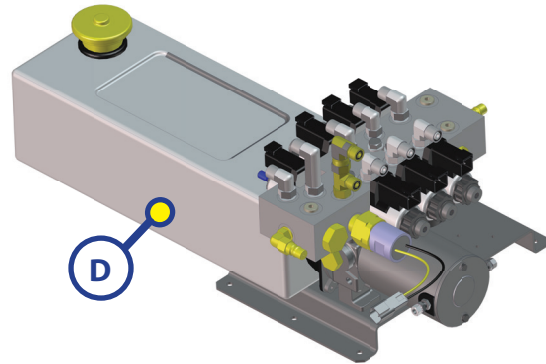
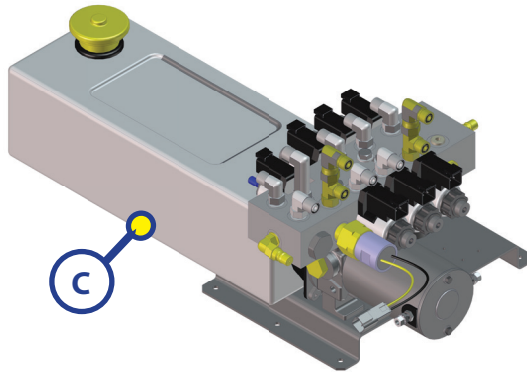
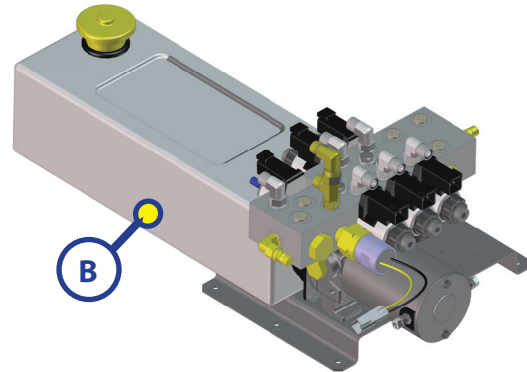
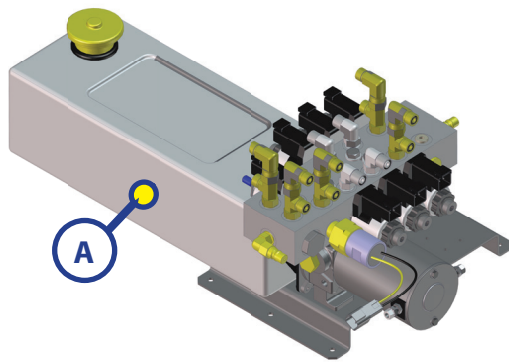

Callout	Part#	Description
A	145941	GT(373) Leveling +2 Power Unit w/ Flow Divider
B	149083	GT(338) Leveling +1 Power Unit
C	149084	GT(359RE, 323, 326, 342, 359, 370) Leveling +2 Power Unit w/ Flow Divider
D	149085	GT(315, 350) Leveling +2 Power Unit
E	149086	GT(319, 391) Leveling +3 Power Unit w/ Flow Divider
F	149087	GT(349, 375, 378) Leveling +3 Power Unit w/ Flow Divider



# MOTORIZED LEVELING BI-ROTATIONAL POWER UNIT COMPONENTS

## LEVELING & STABILIZATION

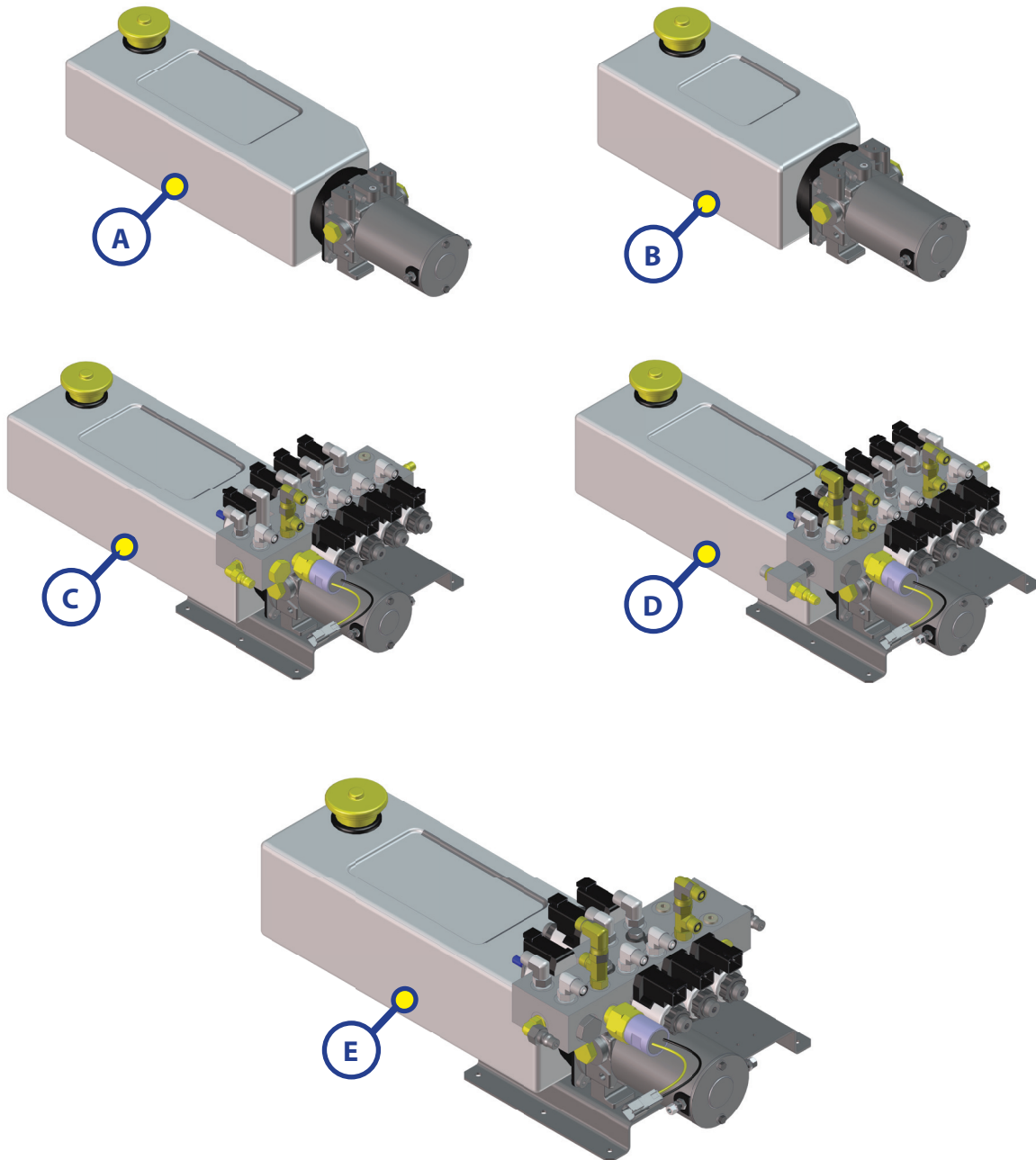

Callout	Part#	Description
A	140500	Hydraulic Power Unit
B	140499	Hydraulic Power Unit
C	149088	GT(340, 350B) Leveling +3 Power Unit
D	179866	Leveling +4 Power Unit w/ Flow Divider
E	141663	Leveling +1 Power Unit w/ Flow Divider