

# Installation Instructions

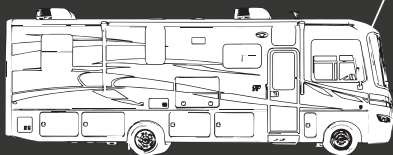

# SMT

## Wireless CoachLink™





*Works with all brands of braking systems!*





Thank you for purchasing the SMI Wireless CoachLink™ System, and welcome to the SMI Family. SMI Mfg. is a family owned and operated business that has been dedicated to creating a safe braking environment for all towed vehicles for nearly 20 years.



Your Wireless CoachLink™ System will give you the confidence that your braking system is functioning as designed from the driver's seat of your coach. This system is a perfect complement to the Air Force One or Stay In Play DUO. It can also be paired with any other braking system to bring assurance that it is braking properly.

We at SMI hope that this is only the beginning of the products we can offer to serve your braking needs. We take pride in caring for each customer, so if there is ever a question about our product please feel free to contact us by phone at 800-893-3763 or email at [info@smibrake.com](mailto:info@smibrake.com).

Sincerely,  
The SMI Team

# Included in your CoachLink™ system:

## Wireless Receiver:

Front

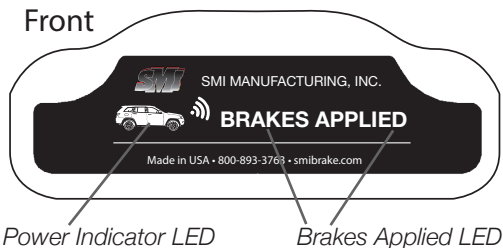

*Power Indicator LED*

*Brakes Applied LED*

Rear

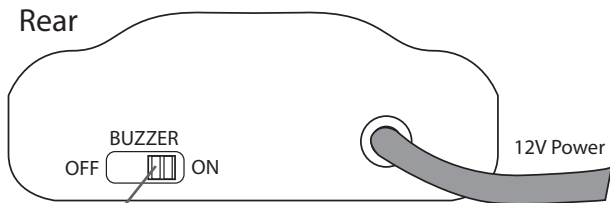

*Buzzer ON/OFF (7 second delay)*

## Wireless Transmitter:

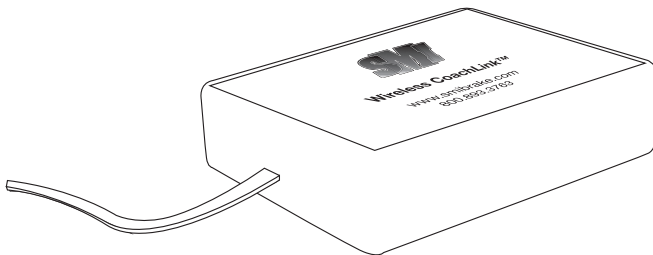

<b>Install Kit</b>	<b>qty.</b>
Butt connector.....	2
Tap in connector.....	1
Single spade tap in connector .....	1
1/4" spade connector male.....	1
1/4" ring terminal.....	1
18" white wire	
3" strip of Velcro .....	4

# STEP 1

## Locate the CoachLink™ Transmitter in the towed vehicle:

For best results, locate the CoachLink™ Transmitter in the far driver's side corner of the dashboard by the windshield.

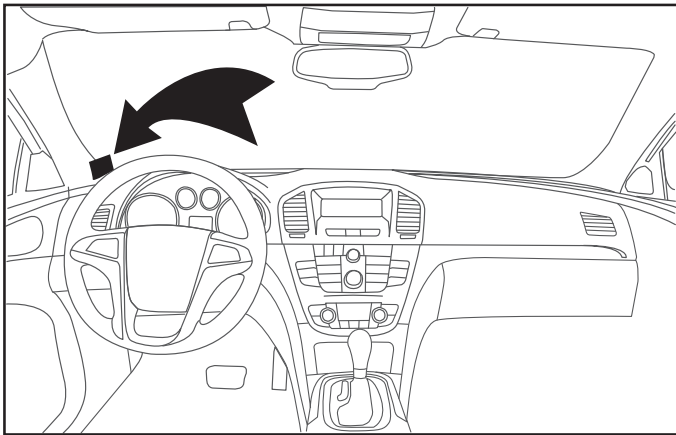

Secure the 900MHz transmitter in place using the provided hook and loop fastener and route the wire around the edge of the dash and down to the driver's footwell area.



**Note:** For a more hidden installation locate the CoachLink™ Transmitter under the driver's side dash area and secure it in place with the provided hook and loop fastener.

# STEP 2A

## Wiring the CoachLink™ Transmitter for use with the Air Force One

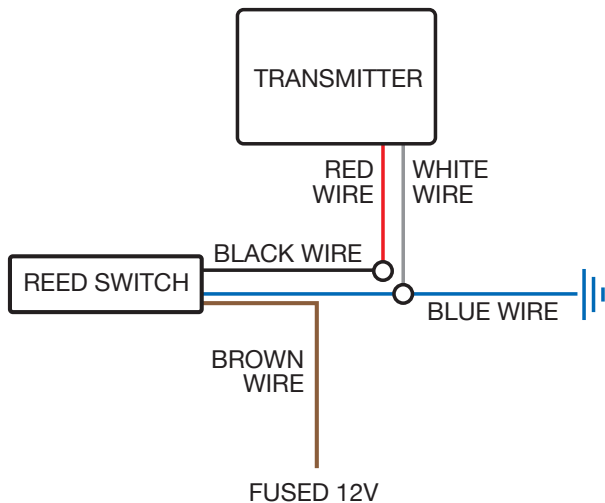

*(For Air Force One Only)*





Connect the red wire on the Wireless CoachLink™ Transmitter to the black wire on the reed switch.

Connect the white wire not the Wireless CoachLink™ Transmitter to the blue wire on the reed switch and to a suitable frame ground.

Note: If the battery is disconnected on the towed be sure to run the ground directly to the negative battery terminal.

Connect the brown wire on the reed switch to the breakaway fuse in the engine compartment of the towed vehicle.



# STEP 2B



## Wiring the CoachLink™ Transmitter for use with the Stay-in-Play DUO

Locate the cold side wire of the towed vehicle's brake light switch. This is the wire that is normally cold (unpowered), but activates 12 volts to the brake lights when the brake pedal is depressed.

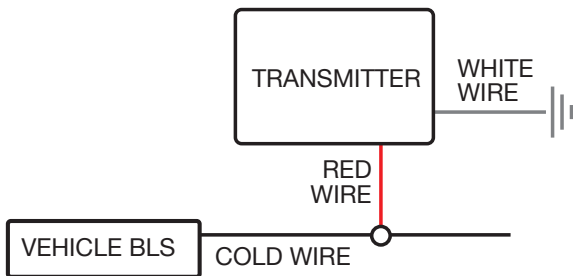

**Note:** If the vehicle has an inactive brake light switch, meaning the cold wire does not receive voltage when the key is in the tow position, connect the red wire to the blue wire on the DUO system.

*(For the DUO only)*

Insert the spade located on the red wire of the CoachLink™ Transmitter cable into the red scotch lock connector.

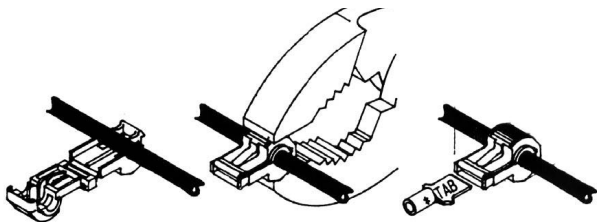

Using Pliers clip the red scotch lock connector over the cold side of the brake light switch. If your vehicle has an active brake light switch connect the red to the blue wire of the Stay N Play DUO operating unit that is under the hood of the towed vehicle.

Connect the white wire to the black wire of the G-Force Controller.

# STEP 2c UNIVERSAL

## Wiring the CoachLink™ Transmitter for universal applications

Locate the cold side wire of the towed vehicle's brake light switch. This is the wire that is normally cold (unpowered), but activates 12 volts to the brake lights when the brake pedal is depressed.

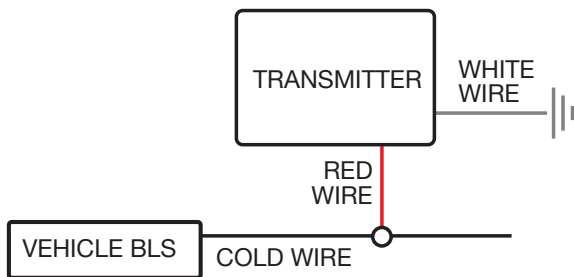

Note: If the vehicle has an inactive brake light switch, meaning the cold wire does not receive voltage when the key is in the tow position an add-on brake light switch will need to be installed separately.

Insert the spade located on the red wire of the CoachLink™ Transmitter cable into the red scotch lock connector.

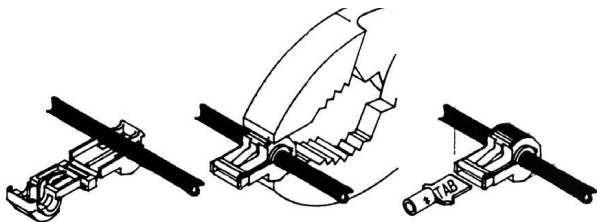

Using Pliers clip the red scotch lock connector over the cold side of the brake light switch. If your vehicle has an active brake light switch connect the red scotch lock connector to the cold side of the aftermarket brake light switch.

Connect the white wire to a suitable frame ground. If your vehicle requires a battery disconnect to tow, or if you are using an add-on brake light switch you must connect the white wire to the negative terminal of the towed vehicle's battery.

# STEP 3

## Install the CoachLink™ Receiver in the coach.

Set the CoachLink Receiver in a location that is easily viewable from the driver's seat of the coach.

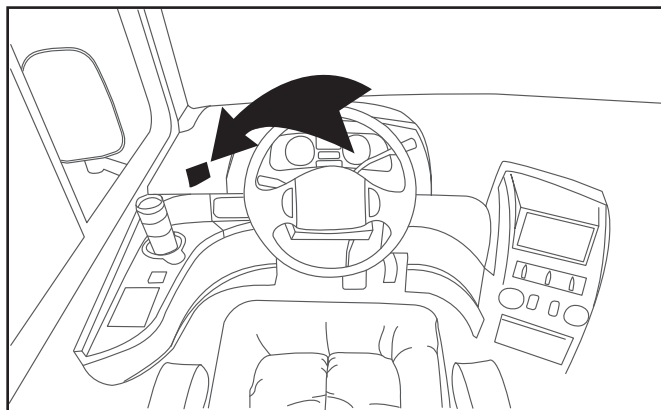

Plug the CoachLink™ Receiver in to an auxiliary 12v plug in the coach dash area.



# STEP 4

## Test the Installation

Locate the towed vehicle behind the coach as if it were going to be towed.

### For Air Force One Installs:

Connect the Air Force One Airline between the towed and the coach and step on the brake pedal in the Coach and hold it down for 2-3 seconds.

### For DUO Installs:

Turn the G-Force Controller switch to the “on” position and pull the breakaway pin from the switch located on the front of the towed vehicle

### For other installs:

Step on the brake pedal in the towed vehicle

Verify that the “Brakes Applied” indicator is illuminated on the CoachLink™ Receiver.

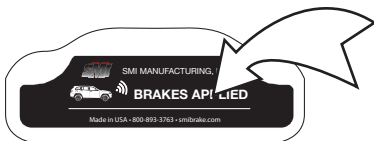





## Refund Policy

SMI has a 30 day return policy on the original date of purchase. Items must have an SMI invoice with corresponding part number to be eligible for refund and are subject to the return authorization policy. All returns are subject to a variable restocking fee not to exceed 20% (not including missing components).

## Limited One (1) Year Warranty



We are confident that our product will perform well and therefore warrant the original purchaser, that the new product will be free from mechanical and electrical defects in material and workmanship during the warranty period. The Warranty period begins on the original purchase date. The warranty is for current production models and the original purchaser only. SMI does not warrant any part of the installation nor failure related to improper installation.



## The Warranty Period



If, during the 12 months of the warranty period, your SMI product should be found defective, SMI will repair or replace the product at its discretion. SMI will refund to the original purchaser freight charges incurred in returning the product to the factory during this portion of the warranty period. (This does not include repackaging charges incurred to a third party) All warranty shipping & freight charges are for normal delivery, expedited freight charges are not included. SMI may choose, at its sole discretion, to allow usage of other new parts for the purpose of warranty repair. Such approval requires prior authorization and is subject to the return authorization policy.







# SMI



SMI Manufacturing Inc.  
7457 W State Route 66  
Newburgh, IN 47630

**1-800-893-3763**  
**SMIBRAKE.COM**

You  Tube

*TECH TIP* 

