



# DH2200

## 2011-15 Ford F-250/F-350/F-450 (Long & Standard Box) Installation Instructions

Serial Number

Please read these Installation Instructions in their entirety prior to installing or operating this equipment.

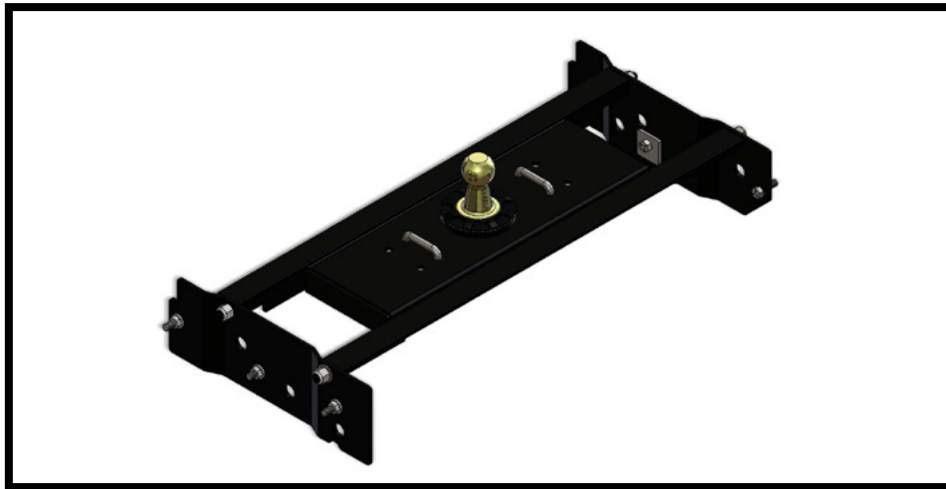

This hitch is rated to 30,000 lbs. Gross Towing Weight and 7,500 lbs. Tongue Weight

**Bolt Torque Specifications**  
Torque in Foot-Pounds for Inch Bolts

Bolt Size	Grade 5	Grade 8
1/4"	10	14
5/16"	19	29
3/8"	33	47
7/16"	54	78
1/2"	78	119
5/8"	154	230
3/4"	257	380

**Bolt Torque Specifications**  
Torque in Foot-Pounds for Metric Bolts

Bolt Size	Grade 8.8	Grade 10.9
6MM	6	8
8MM	16	22
10MM	31	40
12MM	54	70
14MM	89	117
16MM	161	230
18MM	222	318

**! WARNING**

Refer to your vehicle's owner's manual for maximum towing capacity. **DO NOT** exceed vehicle, tongue or hitch weight ratings - failure to follow vehicle manufacturer's recommendations could result in damage to your vehicle, personal injury or death.

**! WARNING**

Failure to read and follow these instructions could result in separation of the trailer from the truck, causing property damage, loss of towed vehicle, personal injury or death.

DH2200  
2011-15 Ford F-250/F-350/F-450 (Long & Standard Box)  
Installation Instructions

 **WARNINGS**

- Trailer brakes are required.
- Always insure there is sufficient clearance between the hitch ball in the stored position and the vehicle's rear differential. A DH9004 plug is available for use when the ball is not stored in the ball housing.
- Do not use any open flame under the truck bed to cut or weld. There is extreme danger of explosion or fire.
- Vehicle must be securely blocked and brakes set before beginning to work underneath the vehicle.
- Do not clamp hitch over any wiring or brake lines.
- Always make sure trailer is loaded slightly tongue heavy. Do not pull a trailer that is lighter on the tongue end.

### ***Maintenance/Care***

- Periodically clean any dirt/debris from the ball and ball housing and moderately lubricate them with white lithium grease or equivalent grease.

**Instruction Notes:** The exhaust hangers are removed and reinstalled for the hitch installation. Some drilling and trimming is required.

Place all components that are removed on a flat, sturdy surface. All items will be reinstalled unless otherwise noted after the hitch is installed.

The dimensional variations between otherwise identical vehicles can be considerable. While this hitch was designed for easy installation, it may be necessary to modify the hitch slightly to compensate for vehicle manufacturer's tolerances.

### ***NOTICE***

- When a bed liner is installed, compensation of the bed liner thickness must be accounted for when measuring the ball location in the box bed.
- When using power drills be aware of the dangers of torque and drill bit length.
- When using a reciprocating saw be aware of objects behind the cutting surface.
- Use a good quality paint to spray cut edges of frame to prevent rusting.
- Be sure to use Loctite® Red on all bolts before tightening. Tighten all bolts according to the torque chart provided.
- The installer must instruct the operator on proper ball installation and locking procedures.
- Dealer or installer be certain the user receives these instruction sheets.
- If the hitch is in an accident, it must be replaced. DO NOT use it again! An accident can cause unseen damage and using it again could result in more damage or serious injury. **DO NOT** use the hitch if it is damaged or missing parts.

**DH2200**  
**2011-15 Ford F-250/F-350/F-450 (Long & Standard Box)**  
**Installation Instructions**

**Tools Required**

Torque Wrench  
 Drill  
 Tape Measure  
 Loctite® RED  
 5" Hole Saw  
 17/32" Drill Bit  
 19/32" Drill Bit  
 10MM Socket  
 3/4" Socket  
 3/4" Wrench  
 15/16" Socket

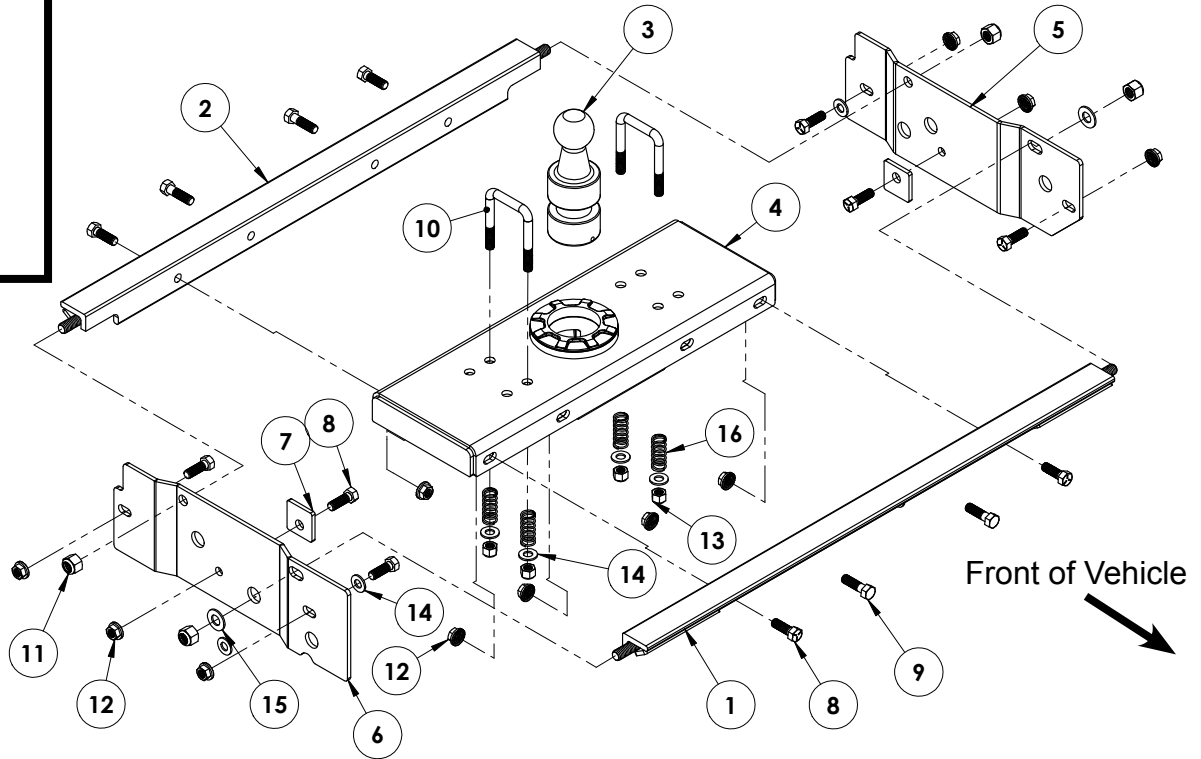

Item No.	Part No.	Description	Qty.
1.....	61-6776 .....	DH2200 Front Cross Member Angle .....	1
2.....	61-6777 .....	DH2200 Back Cross Member Angle.....	1
3.....	62-3822 .....	Hitch Ball .....	1
4.....	62-3995 .....	DH2200 Center Section .....	1
5.....	101-7582 .....	DS Support Plate.....	1
6.....	101-7583 .....	PS Support Plate.....	1
7.....	102-6772 .....	Spacer Plate, 2" x 2" x 1/4".....	2
8.....	201-0051 .....	1/2"-13 x 1-1/2" Hex Head Bolt, Grade 5, ZP .....	10
9.....	201-0068 .....	1/2"-13 x 1-3/4" Hex Head Bolt, Grade 5, ZP .....	4
10.....	201-0275 .....	1/2"-13 x 3-3/4" x 2-1/2" U-Bolt, ZP .....	2
11.....	202-0064 .....	5/8"-11 Hex Nylon Lock Nut, ZP .....	4
12.....	202-0072 .....	1/2"-13 Hex Flange Whiz Lock Nut, ZP .....	14
13.....	202-0094 .....	1/2"-13 Hex Nylon Lock Nut, ZP .....	4
14.....	203-0005 .....	1/2" Flat Washer, ZP.....	8
15.....	203-0106 .....	5/8" Flat Washer, ZP.....	2
16.....	222-0091 .....	Compression Spring (.049" Dia x .60" x 2").....	4
17.....	203-0003(not shown) .....	3/8" Flat Washer, ZP.....	3

**Important:**

Use only genuine factory replacement parts on your hitch. Do **NOT** substitute homemade or non-typical parts. If a bolt is lost or in need of replacement, for your safety and the preservation of your hitch, be sure to use a replacement bolt of the same grade (In most cases it will be Grade 5, please reference the parts list above). Replacement parts may be ordered through your nearest Blue Ox® Dealer or Distributor. Failing to follow and/or altering these installation instructions in either installation or required equipment will void the manufacturer's warranty.

DH2200  
2011-15 Ford F-250/F-350/F-450 (Long & Standard Box)  
Installation Instructions



1. Using the vehicles jack handle tool, remove the spare tire as per vehicles owners manual.

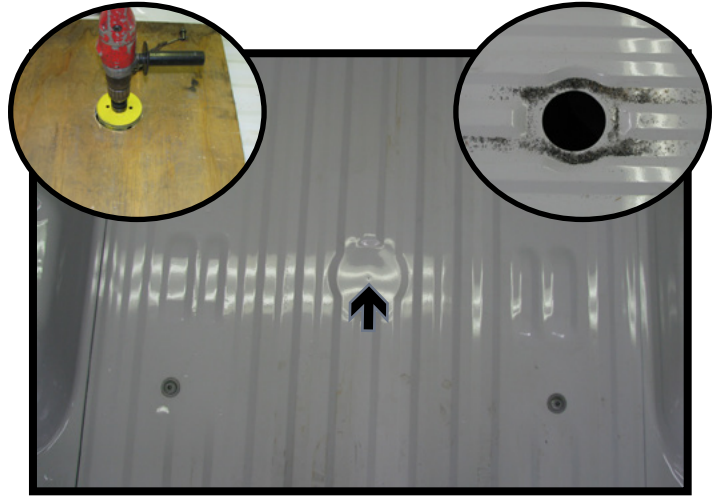

2. Locate the factory center punch located on the flat area between the wheel wells. Using this as a guide, drill a 5" hole thru the bed. If a bed liner is installed measure 46-1/8" from the end of the bed (not the tailgate) and center between the wheel wells.

Note: Using a board while drilling decreases the chances of the bit wobbling out of position.

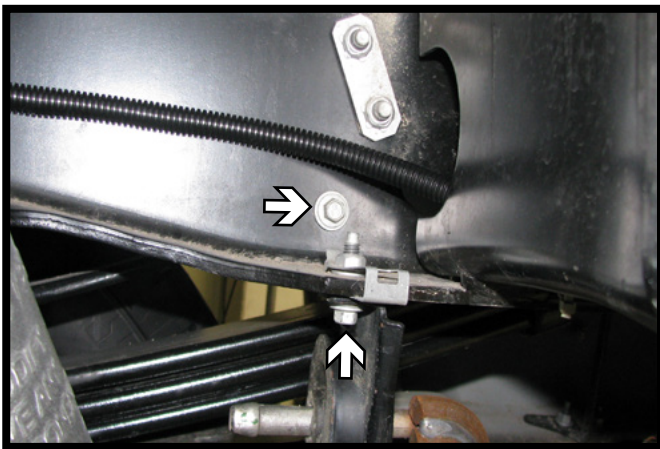

3. On the passenger side only, using a 10MM socket, remove the two (2) bolts from the exhaust hanger.

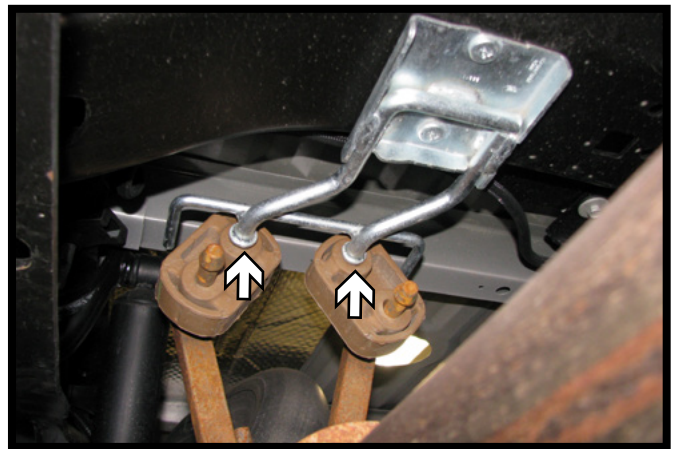

4. Further back, drop the exhaust by sliding the rubber insulators off the hanger studs. Note: Using silicone spray on the insulators eases removal from hangers.

DH2200  
2011-15 Ford F-250/F-350/F-450 (Long & Standard Box)  
Installation Instructions

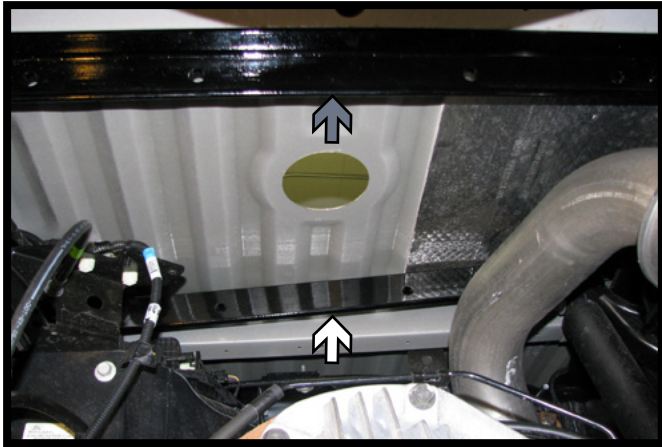

5. Install the rear cross member (36-1/2"L) in front of the hole then slide back to the backside of the hole (gray).

Slide the front cross member (37-1/2"L) in at an angle until forward of the hole (white).



6. Install the center section, aligning with the hole in the bed. Secure in place.



7. On both sides of the center section, bolt the cross members to the center section with four (4) 1/2"-13 x 1-1/2" bolts with 1/2" washers and 1/2"-13 lock nuts on the inside. Do not fully tighten hardware.

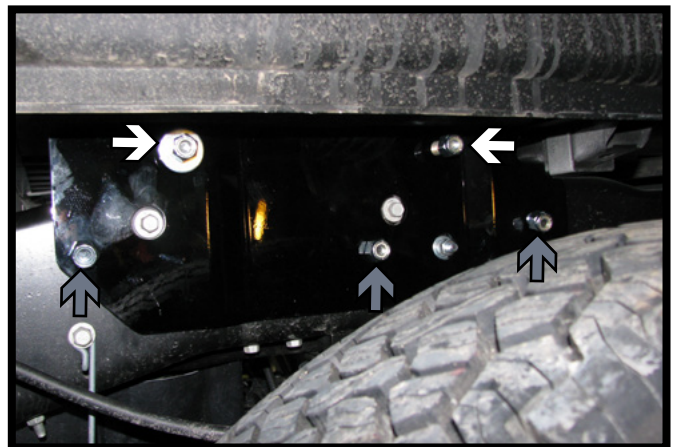

8. On the driver side, attach the support plate to the 5/8"-11 studs of the cross member with a 5/8" washer on the slotted end and 5/8"-11 lock nuts on both (white). Install 1/2"-13 x 1-1/2" bolts with 1/2"-13 lock nuts into the lower three (3) holes, with a 1/4" spacer on the inside of the middle hole (gray).

DH2200  
2011-15 Ford F-250/F-350/F-450 (Long & Standard Box)  
Installation Instructions

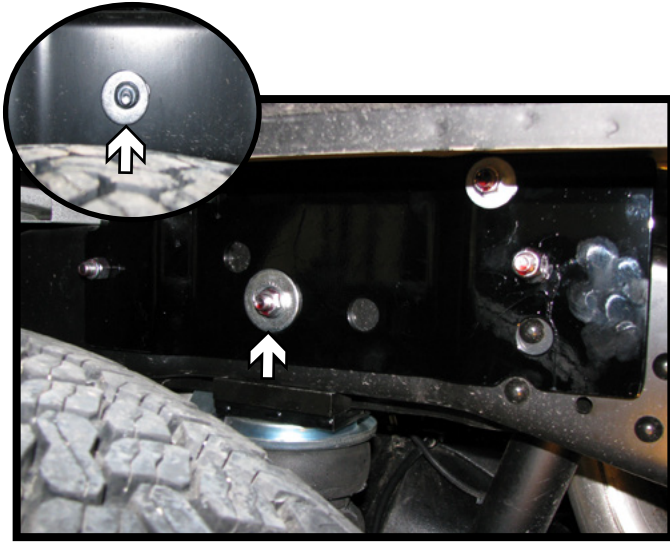

9. Repeat the same steps from step #8 on the passenger side. If the vehicle is equipped with air bags, the nut and washer must be removed prior to support plate installment (inset). Then reattach the washer and nut to the stud after the support plate is installed. Fully tighten both support plates hardware.



10. Check the rotation of the top collar at this time to insure the bed is not rubbing against it and it can rotate freely. If necessary drop the center section and remove any obstructions.



11. Fully tighten all cross member/center section hardware. Then using a 19/32" drill bit, drill the two (2) holes closest to the ball thru the bed. Do this on both sides. Insert the 1/2"-13 u-bolts thru the holes from the topside. Install a 1/2" flat washer, spring, another 1/2" flat washer and 1/2"-13 lock nut onto each u-bolt stud. Tighten until the washers are touching the spring without compressing it.

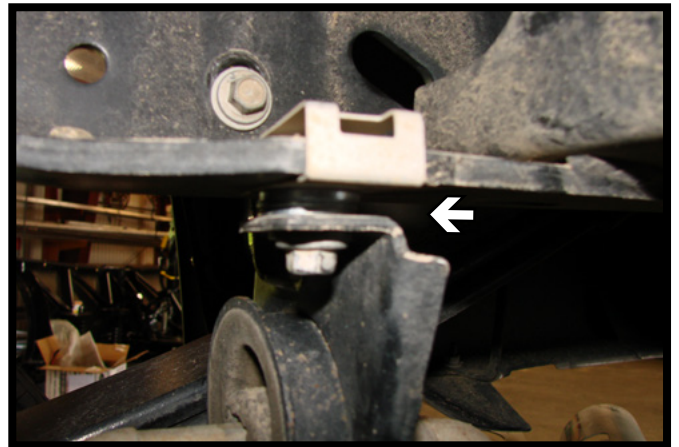

12. Reinstall the exhaust hanger to the frame with three (3) 3/8" washers in between the frame and hanger. Reinstall the exhaust to the factory hangers. Reinstall the spare tire per the vehicles owners manual.

DH2200  
2011-15 Ford F-250/F-350/F-450 (Long & Standard Box)  
Installation Instructions

### Installing the Hitch Ball



1. Rotate the locking collar to release the latch pawl.

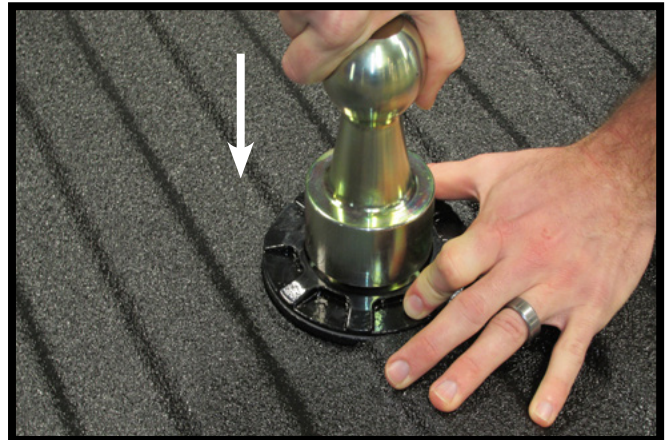

2. Align the ball with the collar and drop the ball into the hitch. Release the locking collar.

### Removing the Hitch Ball



1. Rotate the locking collar to release the latch pawl. Pull straight up on the ball to remove from the hitch.

DH2200  
2011-15 Ford F-250/F-350/F-450 (Long & Standard Box)  
Installation Instructions

### Storing the Hitch Ball



1. Rotate the locking collar to release the latch pawl. Align the ball with the collar and drop the ball into the hitch.

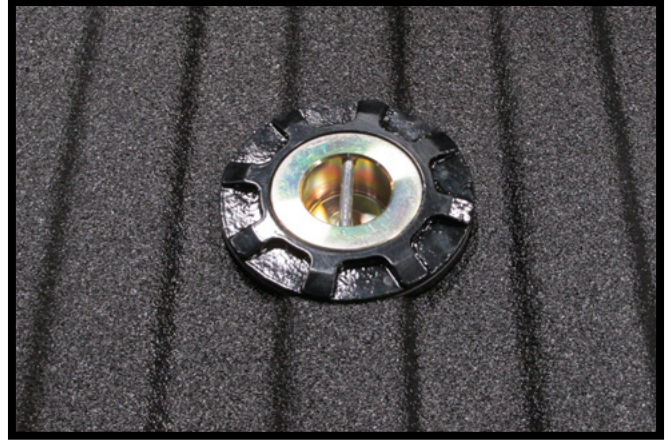

2. Release the locking collar.

### CUSTOMER SERVICE COMMITMENT

Blue Ox® is committed to providing you with exceptional customer care throughout your lifetime with our products. Our team is here to assist you with any questions you may have regarding the performance of your product. Simply call (402) 385-3051 and you can speak with our customer care team.

Additionally, please visit our website to see which rallies our Destination America team will be attending. For a nominal fee, our service technician will service your towing system to ensure it's in proper working condition. Also, as a commitment to our customers, should you visit our factory, you can stay at our full service Blue Ox® campground at no charge along with enjoying a factory tour.

Again, thank you for being our customer and for the confidence you have shown in the performance of our products. It is because of customers like you we enjoy the success we have today.

© 2014 Blue Ox  
One Mill Road, Industrial Park  
Pender, Nebraska 68047  
Phone: (402) 385-3051  
Fax: (402) 385-3360  
[www.blueox.com](http://www.blueox.com)