



DH2300

2011-15 Chevy/GMC 2500/3500 (Standard & Long Box) Installation Instructions

Serial Number

Please read these Installation Instructions in their entirety prior to installing or operating this equipment.



**This hitch is rated to 30,000 lbs. Gross Towing Weight
and 7,500 lbs. Tongue Weight**

Bolt Torque Specifications
Torque in Foot-Pounds for Inch Bolts

Bolt Size	Grade 5	Grade 8
1/4"	10	14
5/16"	19	29
3/8"	33	47
7/16"	54	78
1/2"	78	119
5/8"	154	230
3/4"	257	380

Bolt Torque Specifications
Torque in Foot-Pounds for Metric Bolts

Bolt Size	Grade 8.8	Grade 10.9
6MM	6	8
8MM	16	22
10MM	31	40
12MM	54	70
14MM	89	117
16MM	161	230
18MM	222	318

⚠ WARNING

Refer to your vehicle's owner's manual for maximum towing capacity. **DO NOT** exceed vehicle, tongue or hitch weight ratings - failure to follow vehicle manufacturer's recommendations could result in damage to your vehicle, personal injury or death.

⚠ WARNING

Failure to read and follow these instructions could result in separation of the trailer from the truck, causing property damage, loss of towed vehicle, personal injury or death.

DH2300
2011-15 Chevy/GMC 2500/3500 (Standard & Long Box)
Installation Instructions

 **WARNINGS**

- Trailer brakes are required.
- Always insure there is sufficient clearance between the hitch ball in the stored position and the vehicle's rear differential.
- Do not use any open flame under the truck bed to cut or weld. There is extreme danger of explosion or fire.
- Vehicle must be securely blocked and brakes set before beginning to work underneath the vehicle.
- Do not clamp hitch over any wiring or brake lines.
- Always make sure trailer is loaded slightly tongue heavy. Do not pull a trailer that is lighter on the tongue end.
- Always insure the hitch ball is locked into the hitch prior to towing.

Maintenance/Care

- Periodically clean any dirt/debris from the ball and ball housing and moderately lubricate them with white lithium grease or equivalent grease.

Instruction Notes: The exhaust hangers are removed and reinstalled for the hitch installation. Some drilling and trimming is required.

Place all components that are removed on a flat, sturdy surface. All items will be reinstalled unless otherwise noted after the hitch is installed.

The dimensional variations between otherwise identical vehicles can be considerable. While this hitch was designed for easy installation, it may be necessary to modify the hitch slightly to compensate for vehicle manufacturer's tolerances.

NOTICE

- When a bed liner is installed, compensation of the bed liner thickness must be accounted for when measuring the ball location in the box bed.
- When using power drills be aware of the dangers of torque and drill bit length.
- When using a reciprocating saw be aware of objects behind the cutting surface.
- Use a good quality paint to spray cut edges of frame to prevent rusting.
- Be sure to use Loctite® Red on all bolts before tightening. Tighten all bolts according to the torque chart provided.
- The installer must instruct the operator on proper ball installation and locking procedures.
- Dealer or installer be certain the user receives these instruction sheets.
- If the hitch is in an accident, it must be replaced. DO NOT use it again! An accident can cause unseen damage and using it again could result in more damage or serious injury. **DO NOT** use the hitch if it is damaged or missing parts.

DH2300

2011-15 Chevy/GMC 2500/3500 (Standard & Long Box)

Installation Instructions

- Tools Required**

 - Torque Wrench
 - Drill
 - Tape Measure
 - Loctite® RED
 - 5" Hole Saw
 - 19/32" Drill Bit
 - 3/4" Socket
 - 3/4" Wrench
 - 15/16" Socket

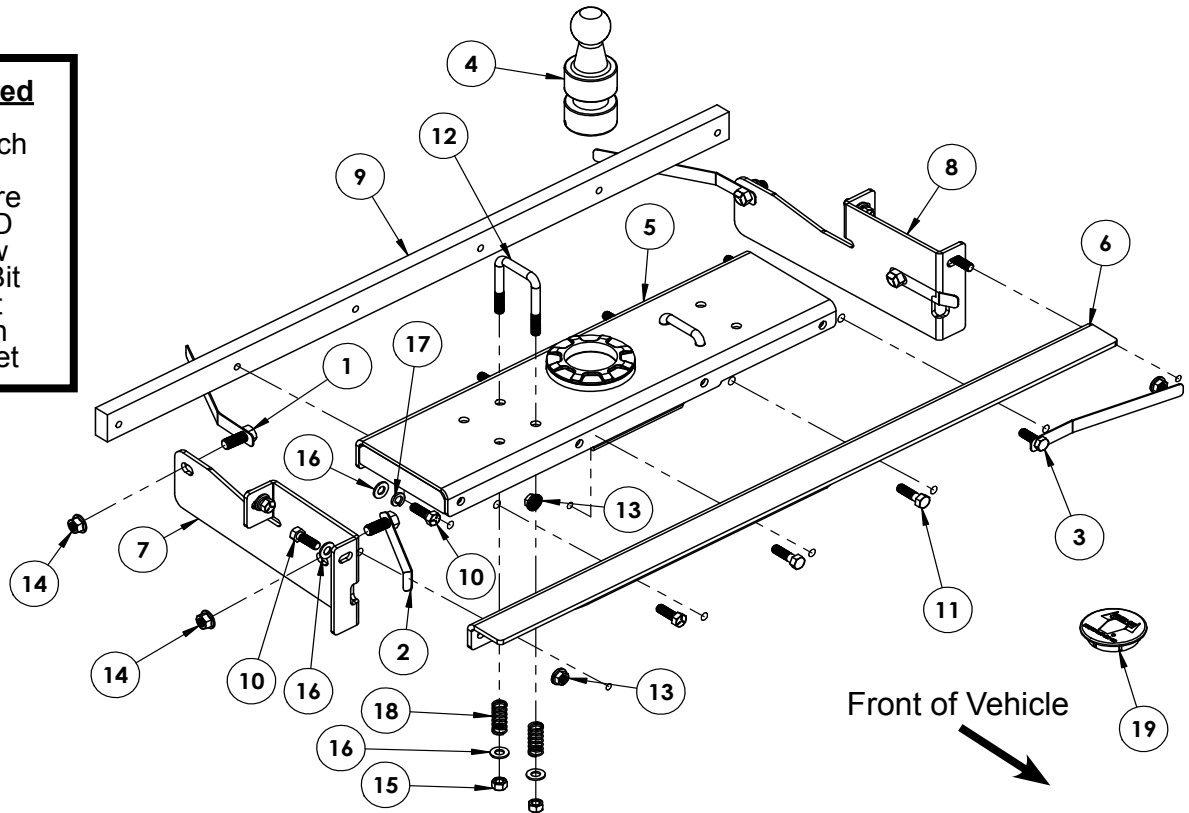

Item No.	Part No.	Description	Qty.
1.....	61-6817	5/8"-11 Hex Bolt Plate x 10-1/2"L	2
2.....	61-6818	5/8"-11 Hex Bolt Plate x 5"L.....	2
3.....	61-7328	1/2"-13 Hex Bolt Plate x 10-1/2"L.....	1
4.....	62-3822	Hitch Ball	1
5.....	62-3996	DH2300 Center Section	1
6.....	101-8040	DH2300 Front Cross Member	1
7.....	101-8041	DH2300 PS Side Plate	1
8.....	101-8042	DH2300 DS Side Plate.....	1
9.....	102-7416	DH2300 Back Cross Member.....	1
10.....	201-0051	1/2"-13 x 1-1/2" Hex Head Bolt, Grade 5, ZP	7
11.....	201-0068	1/2"-13 x 1-3/4" Hex Head Bolt, Grade 5, ZP	4
12.....	201-0275	1/2"-13 x 3-3/4" x 2-1/2" U-Bolt, ZP	2
13.....	202-0072	1/2"-13 Hex Flange Whiz Lock Nut, ZP	6
14.....	202-0073	5/8"-11 Hex Flange Whiz Lock Nut, ZP	4
15.....	202-0185	1/2"-13 Hex Nylon Lock Nut, Grade 8, ZP.....	4
16.....	203-0005	1/2" Flat Washer, ZP.....	12
17.....	203-0012	1/2" Lock Washer, ZP	6
18.....	222-0091	Compression Spring (.049" Dia x .60" x 2").....	4
19.....	250-0264(not shown)	Ball Housing Plug	1

Important:

Use only genuine factory replacement parts on your hitch. Do **NOT** substitute homemade or non-typical parts. If a bolt is lost or in need of replacement, for your safety and the preservation of your hitch, be sure to use a replacement bolt of the same grade (In most cases it will be Grade 5, please reference the parts list above). Replacement parts may be ordered through your nearest Blue Ox® Dealer or Distributor. Failing to follow and/or altering these installation instructions in either installation or required equipment will void the manufacturer's warranty.

DH2300
2011-15 Chevy/GMC 2500/3500 (Standard & Long Box)
Installation Instructions



1. Using the vehicles jack handle tool, remove the spare tire as per vehicles owners manual.

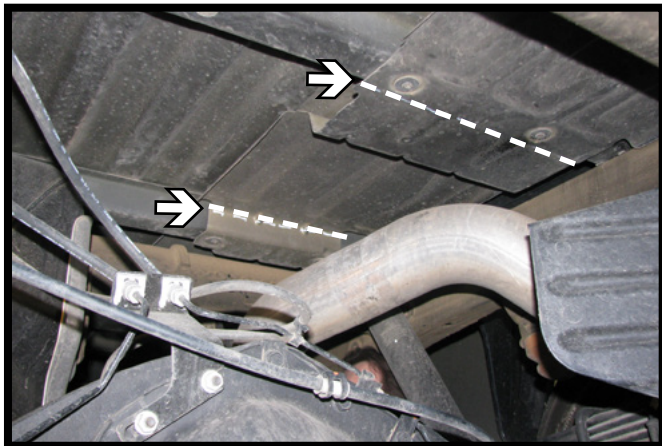
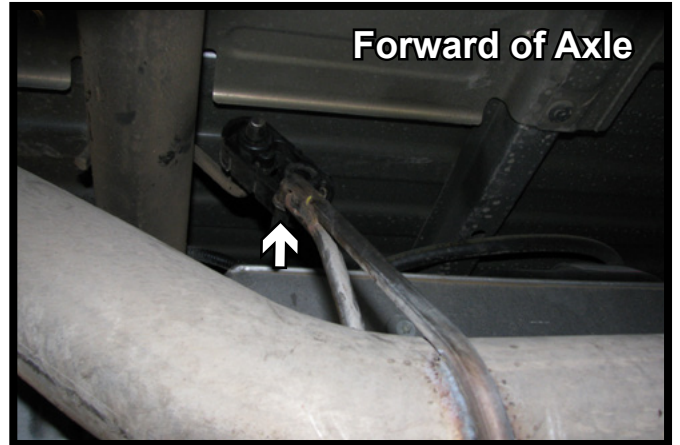

3. Remove the heat shield by cutting between two (2) bed frame rails on the underside of the bed above the axle (as shown by the dotted lines).



2. Drop the exhaust by sliding the three (3) hangers out of the rubber insulators. There is one (1) on either side of the axle and one (1) in back of the muffler. Note: Using silicone spray on the hangers eases removal from rubber insulators.

DH2300
2011-15 Chevy/GMC 2500/3500 (Standard & Long Box)
Installation Instructions

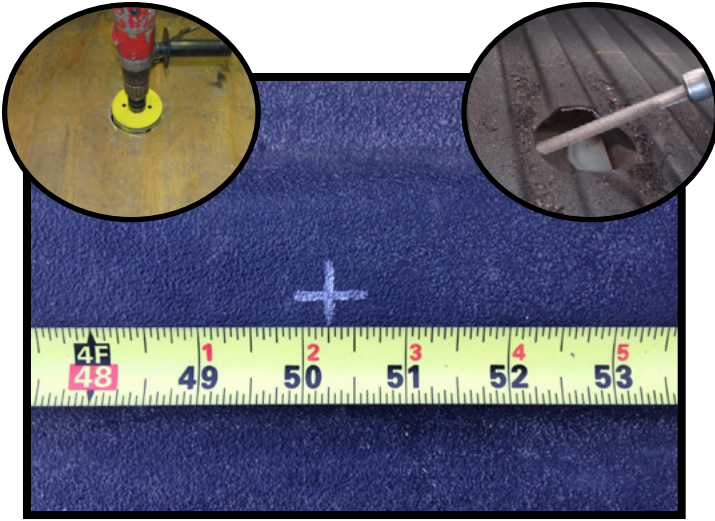

4. On the inside of the bed, measure from the rear (not the tailgate) forward 50-1/4" for a 8' bed or 45-1/2" for a 6'-6" bed and mark. Measure between the wheel wells and mark center. Using a 5" holesaw, drill a hole thru the bed.

Note: Using a board while drilling decreases chances of the bit wobbling out of position (left inset). It is also recommended to debur the hole so the hitch will sit tight against the bed (right inset).



5. Slide the cross members in from the side. Push the flat end in just ahead of the rib. Slide the angle in part way, lift up and bend the rib then finish pushing it in, then bend the rib back. Turn so that the holes are on the lower side, facing down and to the back.

Optional: Loosen the bed bolts and lift the bed to clear cross members.



6. Install the center section, by sliding it in from the backside over the axle then aligning with the hole in the bed. Secure in place.



7. On both sides of the center section, bolt the cross members to the center section with the supplied 1/2" hardware. Do not fully tighten hardware.

DH2300
2011-15 Chevy/GMC 2500/3500 (Standard & Long Box)
Installation Instructions



8. On the backside of the bed rib, measure to the 1"x2" cross member. Set to an equal distance on both sides so the hitch is square with the vehicle.



9. Align the holes at the end of the angle and the rear cross member. Install a 1/2"-13 x 1-1/2" bolt with a 1/2" lock and flat washer. On the front use a 1/2"-13 x 1-1/2" bolt with a 1/2" lock washer and 1/2"-13 nut. Do this on both sides of the vehicle.



10. Insert a 5"L x 5/8"-11 bolt plate into the front opening. Slide the bolt into the hole and push back so that the bolt comes through the front hole. Install a 5/8" lock washer and 5/8"-11 hex nut onto the bolt. Do this on both sides of the vehicle.



11. Insert the 11"L x 5/8"-11 bolt plate in the opening forward of the fuel tank. Turn the bolt so that it is pointing out. Align with the hole on the outside edge of the frame. Install a 5/8" lock washer and 5/8"-11 hex nut onto the bolt. Do this on both sides of the vehicle.

DH2300
2011-15 Chevy/GMC 2500/3500 (Standard & Long Box)
Installation Instructions



12. Tighten and torque all bolts. First torque the 5/8" bolts. Then torque the outside 1/2" bolts and work in to the 1/2" center section bolts.



13. Check the rotation of the top collar at this time to insure the bed is not rubbing against it and it can rotate freely. If necessary drop the center section and remove any obstructions.

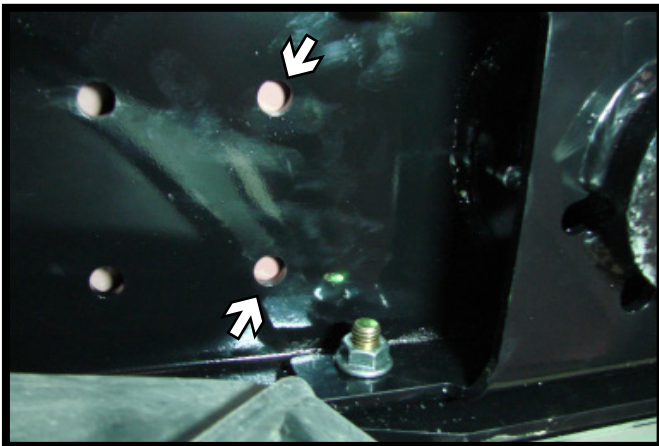

14. Using a 19/32" drill bit, drill the two (2) holes closest to the ball thru the bed. Do this on both sides of the center section.



16. Reinstall the exhaust to the factory hangers. Reinstall the spare tire per the vehicles owners manual.

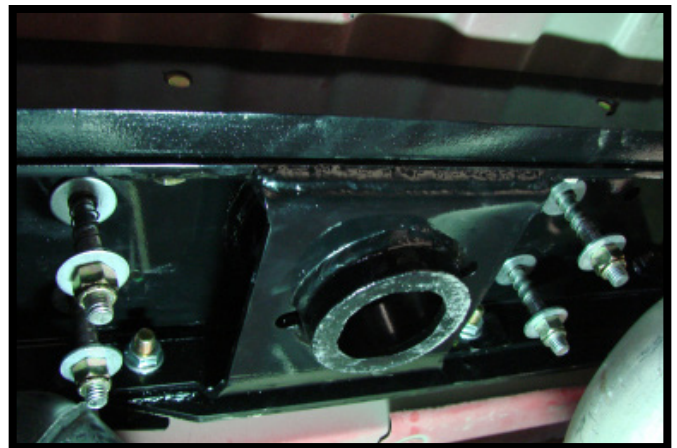

15. Insert the 1/2"-13 u-bolts thru the holes from the topside. Install a 1/2" flat washer, a spring, another 1/2" flat washer and 1/2"-13 lock nut onto each u-bolt stud. Tighten until the washers are touching the spring without compressing it.

DH2300
2011-15 Chevy/GMC 2500/3500 (Standard & Long Box)
Installation Instructions

Installing the Hitch Ball

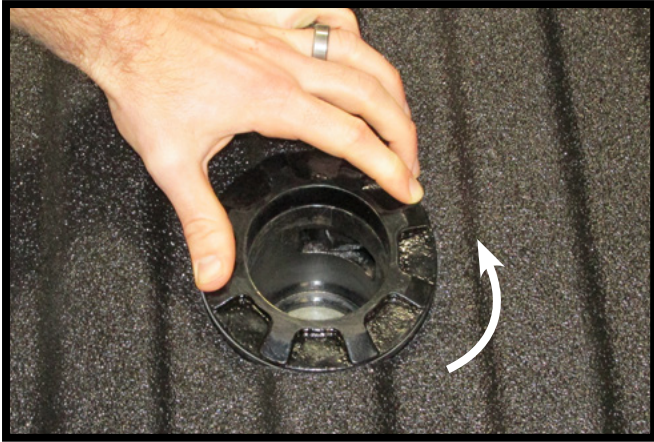

1. Rotate the locking collar to release the latch pawl.

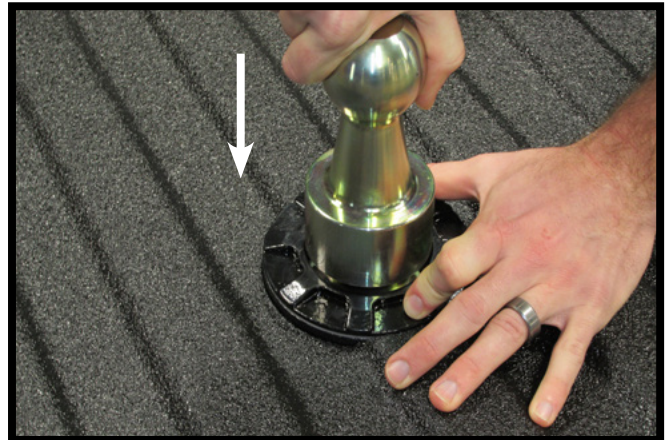

2. Align the ball with the collar and drop the ball into the hitch. Release the locking collar. Pull up on the ball to insure it is locked into the housing.

Removing the Hitch Ball



1. Rotate the locking collar to release the latch pawl. Pull straight up on the ball to remove from the hitch.

DH2300
2011-15 Chevy/GMC 2500/3500 (Standard & Long Box)
Installation Instructions

Storing the Hitch Ball



1. Rotate the locking collar to release the latch pawl. Align the ball with the collar and drop the ball into the hitch.

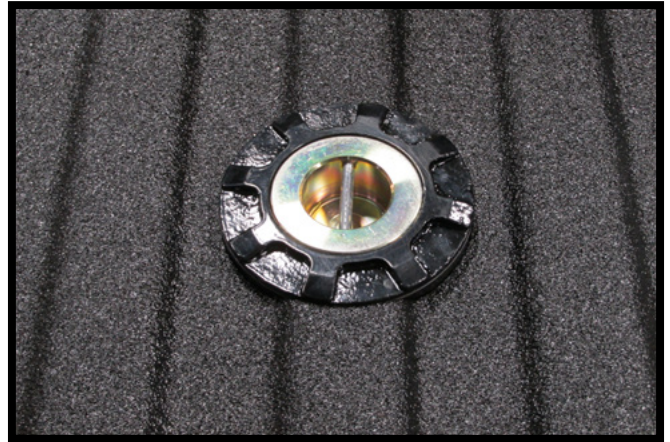

2. Release the locking collar.

CUSTOMER SERVICE COMMITMENT

Blue Ox® is committed to providing you with exceptional customer care throughout your lifetime with our products. Our team is here to assist you with any questions you may have regarding the performance of your product. Simply call (402) 385-3051 and you can speak with our customer care team.

Additionally, please visit our website to see which rallies our Destination America team will be attending. For a nominal fee, our service technician will service your towing system to ensure it's in proper working condition. Also, as a commitment to our customers, should you visit our factory, you can stay at our full service Blue Ox® campground at no charge along with enjoying a factory tour.

Again, thank you for being our customer and for the confidence you have shown in the performance of our products. It is because of customers like you we enjoy the success we have today.

© 2014 Blue Ox
One Mill Road, Industrial Park
Pender, Nebraska 68047
Phone: (402) 385-3051
Fax: (402) 385-3360
www.blueox.com