



VQ4500 & VQ4510 Owner's Manual

This manual contains detailed information on your KING Tailgater.

To start watching TV right away,
use the Quick Reference Guide.



For **dish**

PRODUCT REGISTRATION

To provide ongoing technical support and to better facilitate warranty processing, please register your product at www.kingconnect.com/products/product-registration/.



TABLE OF CONTENTS

Introduction	2
Important Safety Instructions	2
KING Tailgater Package Contents	2
Apply Rubber Feet to Antenna Unit	3
About Signal Loss	3
About Satellite TV Reception	4
Connect Receiver to TV	4
KING Tailgater Setup	5
KING Tailgater Operation	6-12
First Time KING Tailgater Operation with New Receiver	6-9
Standard KING Tailgater Operation	10-12
Second Receiver Operation	14-15
Proper Care of Your Equipment	16
Security	16
Accessories	17
Permanent Installation	18-21
Troubleshooting	22-25
Manufacturer's Limited Warranty	26
FCC Guidelines	27

Please record
PURCHASE DATE

____/____/____
Month / Day / Year

SERIAL NUMBER INFORMATION

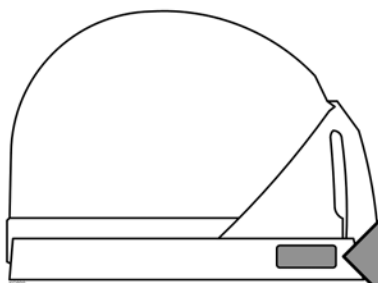

ALSO LOCATED HERE

Apply serial number decal here.

HDMI is a registered trademark of HDMI Licensing L.L.C.
DISH and Tailgater are registered trademarks of DISH Network L.L.C.
KING and Dome Magic are registered trademarks of Electronic Controlled Systems, Inc.



INTRODUCTION

Thank you for choosing DISH and the KING Tailgater Portable HDTV System!

You are about to experience the excitement of DISH satellite television programming and the convenience of the KING Tailgater portable antenna, which delivers the very best picture and sound quality wherever you go.

The KING Tailgater allows you to decide how and where you watch your DISH service. If you need to activate service, call 1-800-963-DISH (3474) to speak with a mobile antenna expert.

IMPORTANT SAFETY INSTRUCTIONS

1. Please read this Owner's Manual thoroughly before using the KING Tailgater.
2. Keep this Owner's Manual and the included Quick Reference Guide in a safe place for future reference.
3. Follow all instructions and warnings. Set up and operate the KING Tailgater in accordance with the instructions.
4. Do not power wash the KING Tailgater. Do not submerge the KING Tailgater or place in standing water. Hand wash only with mild soap and water. See page 16 for additional care instructions.
5. Do not operate near any indoor or outdoor heat source such as radiators, heat registers, stoves, barbecues, campfires, or other items that produce heat.
6. Servicing may be required if the unit has been dropped or damaged in any way or if the unit does not operate normally. Call the KING Service Department at (952) 345-8147.
7. Tighten all of the coax cable connections only by hand. If you use a wrench, you may over tighten the connections and damage your equipment.
8. To avoid risk of electric shock, unplug your receiver before connecting the KING Tailgater in damp or wet conditions.

KING TAILGATER PACKAGE CONTENTS

Antenna Unit

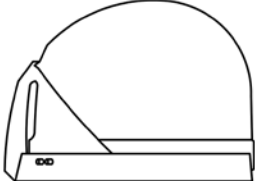

(3) Rubber Feet



50' RG-6 Coax Cable



Owner's Manual



Quick Reference Guide



Registration Card



You will also need (sold separately):

DISH Programming Subscription



DISH HD Solo Receiver*



Receiver to TV cable(s)

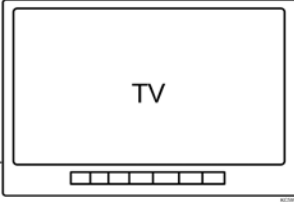

NOTE: The VQ4510 includes the receiver and cables.

*Model ViP® 211z, ViP211k, ViP211 or 411

Receiver models compatible with the KING Tailgater may change. This list may not be complete.

Please visit www.kingcontrols.com/dish-receivers for the most up to date receiver information.

APPLY RUBBER FEET TO ANTENNA UNIT

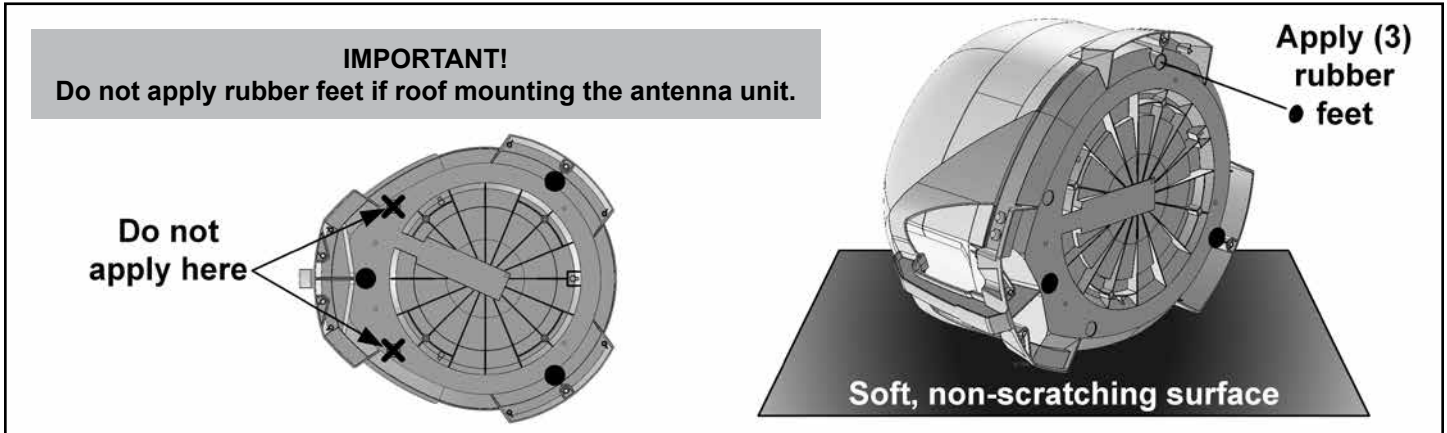

ABOUT SIGNAL LOSS

Because of the small size of the highly portable KING Tailgater, signal strength may not be as strong as with a fixed home antenna.

OBSTRUCTIONS

The KING Tailgater requires an unobstructed view of the southern sky for the best signal reception.

Be sure to place the KING Tailgater in a location free from obstructions such as people, trees, buildings, vehicles, etc. This will allow for the strongest signal and will help prevent any interruption to your programming. Point the handle approximately north to speed up search time.

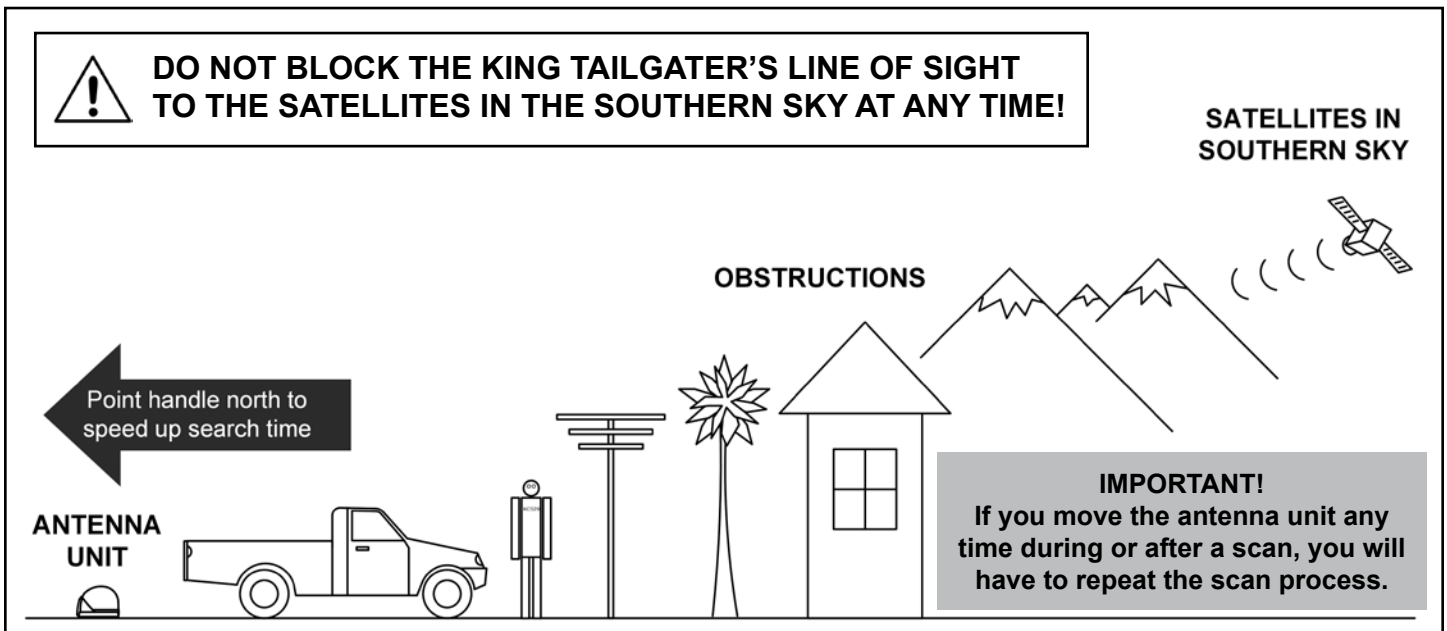

RAIN AND SNOW FADE

Though rare, heavy rain, snow, or dense cloud cover can reduce the satellite signal, which may interrupt your programming. Your programming should return as conditions improve.

ABOUT SATELLITE TV RECEPTION

Satellite television uses satellites in a geostationary orbit over the earth. This type of orbit enables the satellites to stay aligned over one place on the surface of the earth and to transmit your television programming to the KING Tailgater when pointed at the appropriate satellite.

Your television programming is delivered from up to 3 satellites located at the 110°, 119°, and 129° west longitudes. The KING Tailgater will automatically find and then switch between satellites as you change channels to offer you the ideal viewing experience.

Due to the low look angle for the 129 satellite in the northeastern region of the United States, you may experience difficulty viewing programming from the 129 satellite while in this area. (Programming from the 110 and 119 satellites should still be available.)

CONNECT RECEIVER TO TV



DO NOT PLUG IN OR TURN ON RECEIVER AT THIS TIME.

1. Connect your DISH HD Solo Receiver (ViP211z, ViP211k, ViP211 or 411)¹ to your TV using the best connection type supported by your TV. (See your TV owner's manual for its connection options. Connection type and location may vary by model.)²

Back of DISH ViP211z Receiver

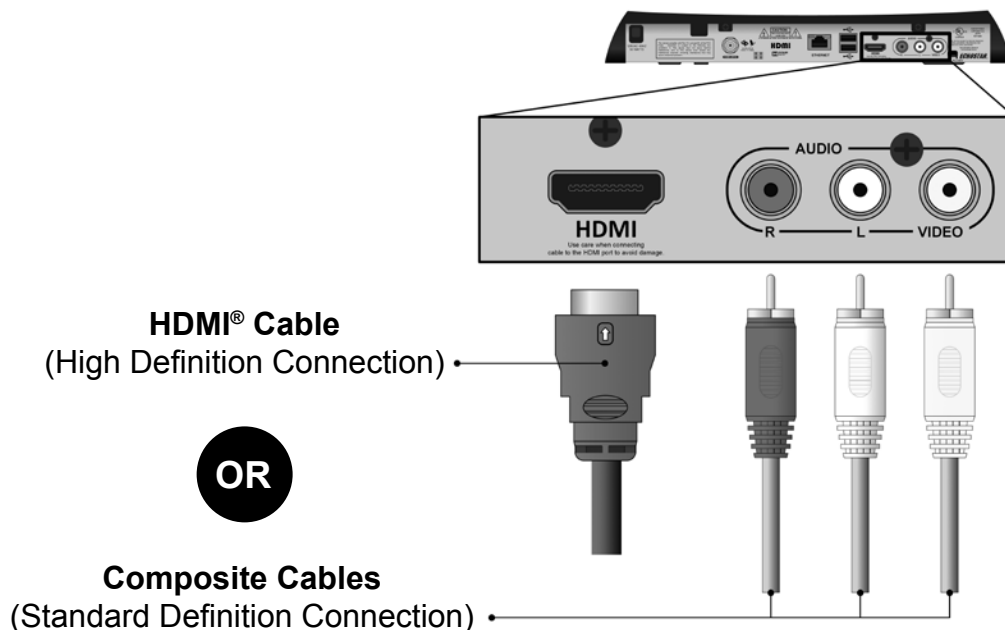

1) Receiver models compatible with the KING Tailgater may change. This list may not be complete. Please visit www.kingconnect.com/dish-receivers for the most up to date receiver information.



2) Your receiver may also have standard definition "TV SET OUT" and "S-VIDEO" ports, and high definition "COMPONENT" ports to view video. See your receiver owner's manual for more information.

KING TAILGATER SETUP

The KING Tailgater requires an unobstructed view of the southern sky for signal reception. Be sure to place the KING Tailgater in a location free from obstructions such as trees, buildings, etc. (See page 3.) Point the handle approximately north to speed up search time.



HAND TIGHTEN COAX. OVER TIGHTENING CAN DAMAGE CONNECTIONS.

1. Connect one end of the supplied RG-6 coax cable to the MAIN port on the KING Tailgater and place in position. It is recommended you use only the supplied RG-6 coax cable.
2. Connect the other end of the supplied coax cable to the **SATELLITE IN** port on your receiver.



Right Rear of KING Tailgater



Back of DISH ViP211z Receiver



Connect to SATELLITE IN only!

Supplied RG-6 coax

- Do not put the KING Tailgater where it can be bumped, knocked over or struck by a person or vehicle.
- Do not put the KING Tailgater near any heat sources.
- Do not route the coax cable where it can be tripped on or run over by a vehicle.
- Do not over tighten the coax cable connections.
- Do not put sharp bends or kinks in the coax cable.



NOTE: Place the KING Tailgater on a stable and reasonably level surface with a clear view of the southern sky. When placing the KING Tailgater in position, be sure surface is dry and free of loose dirt or sand.

3. Plug your receiver into a 110 volt AC power source.

The green power light on your receiver should illuminate or begin cycling on and off.

Wait for the green light to turn solid. This may take up to two minutes.

If it does not turn solid, power on your receiver using the front panel POWER button. (On “z” models, this is located behind the door panel.)



Front of ViP®211z receiver with door open

4. Plug in and turn on your TV.

In your TV’s input selection menu, choose the input that matches the connection from your receiver. (Example: If using an HDMI cable from your receiver, choose the HDMI input on your TV.) See your TV owner’s manual for details.

KING TAILGATER OPERATION

IF YOU ARE USING A NEW RECEIVER WITH THE KING TAILGATER, YOU MUST FOLLOW THE FIRST TIME SETUP PROCEDURE STARTING BELOW.



AFTER THIS FIRST TIME PROCEDURE, YOU CAN USE “STANDARD KING TAILGATER OPERATION” STARTING ON PAGE 10.

FIRST TIME KING TAILGATER OPERATION WITH NEW RECEIVER



MAKE SURE TO INSTALL THE BATTERIES IN THE RECEIVER’S REMOTE CONTROL (INCLUDED WITH REMOTE CONTROL).

1. Point your receiver’s remote at the front of the receiver and press SAT.

Press RECORD.

When a number appears in the box, verify CONTINUE is highlighted.

Press SELECT on your remote.

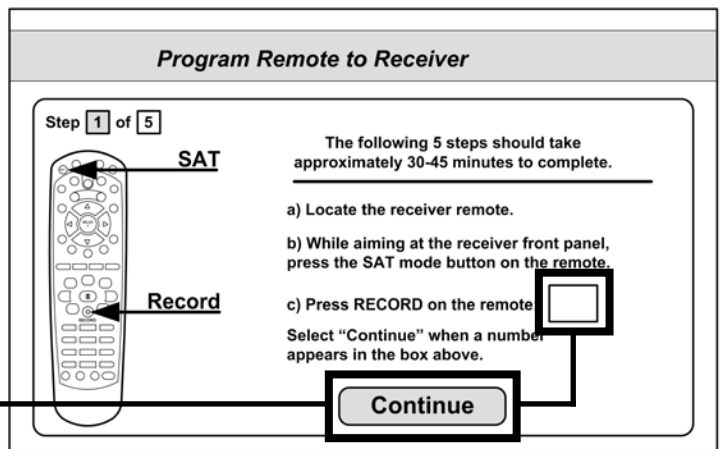

The *Portable Antenna Setup* screen will display.

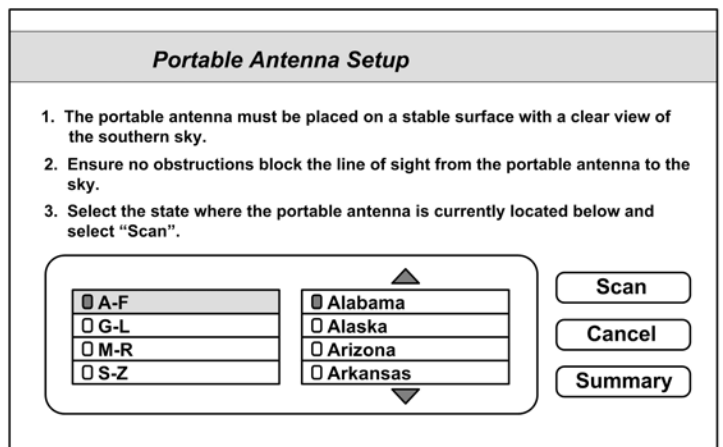

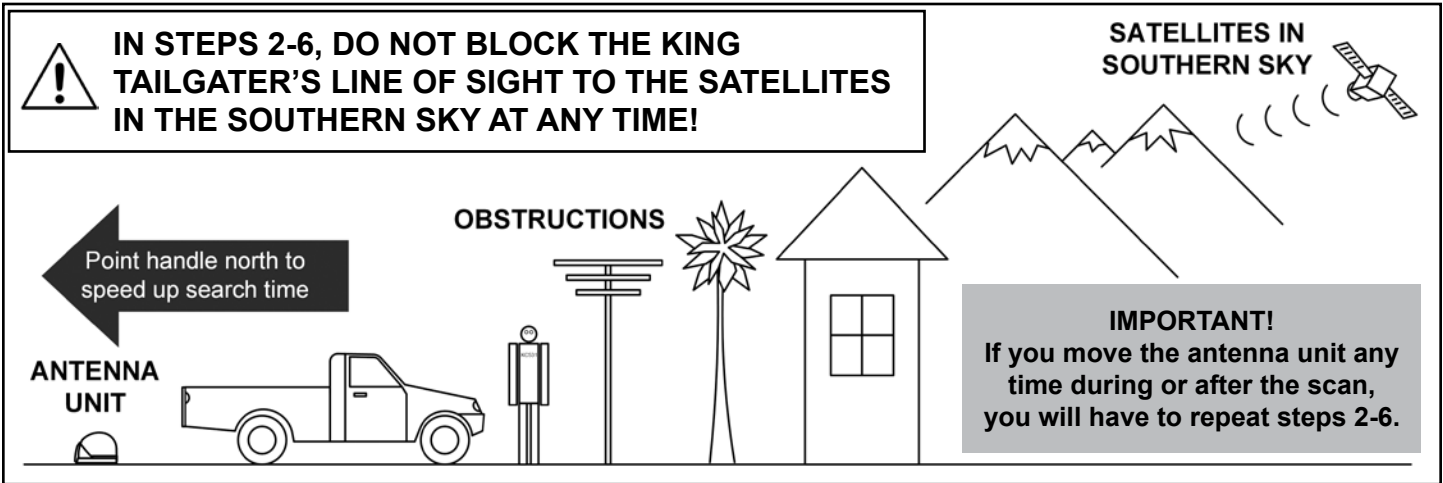

2. Use the arrow buttons on your remote to highlight the letter group that includes the first letter of the state you are currently in.

Press SELECT.

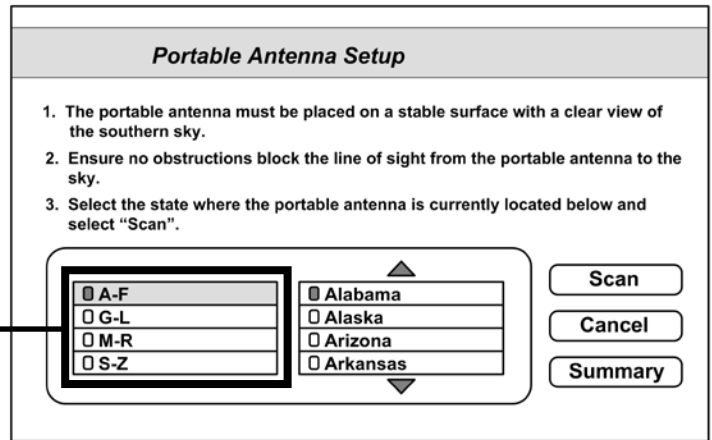

3. Highlight the state you are currently in from the state menu.

Press SELECT.

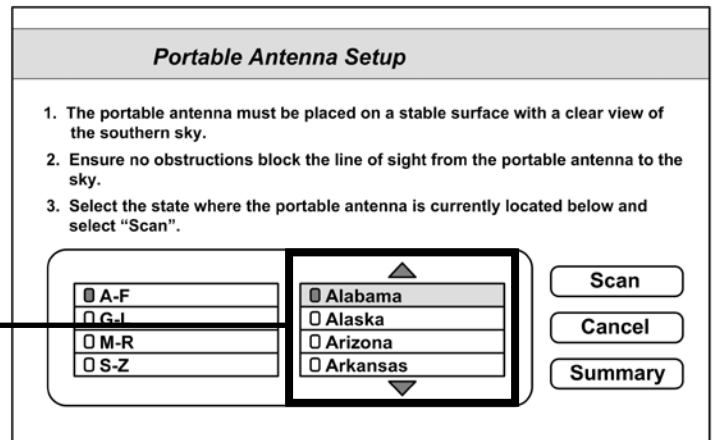

4. Verify Scan is highlighted.

Press SELECT.

The scan will begin and may take up to several minutes to complete.

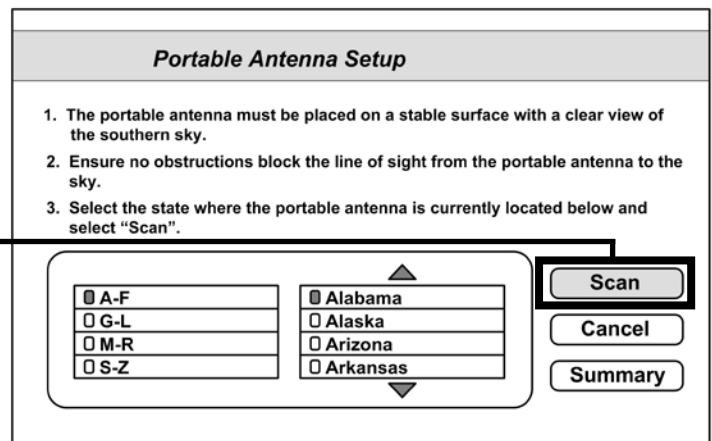

The receiver will download software for the KING Tailgater. This step may take 20-25 minutes.

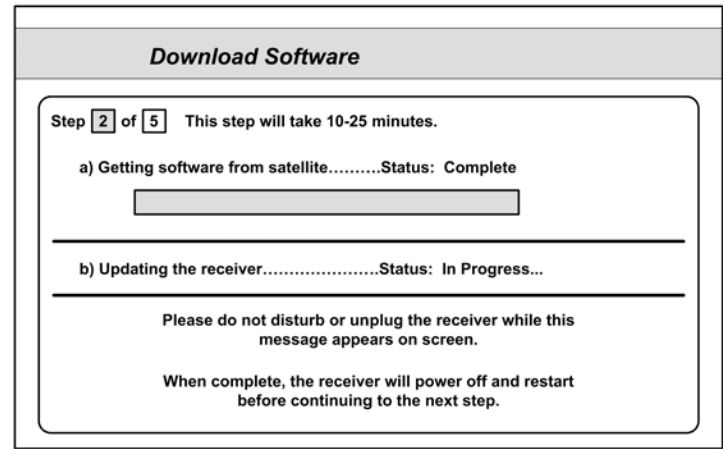
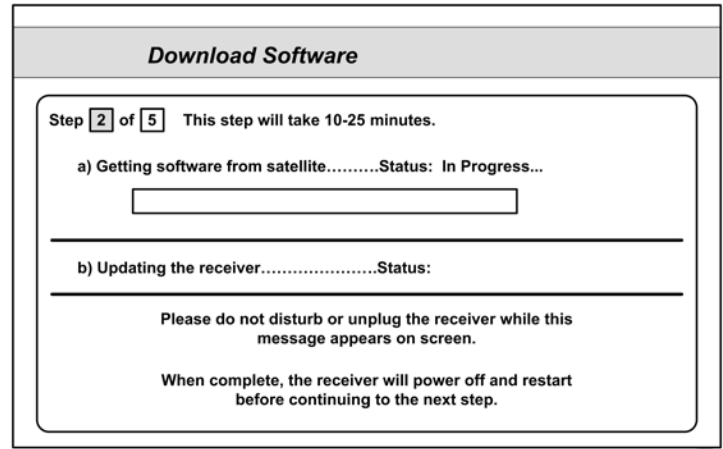

5. The receiver will reset and the *Mobile Antenna Setup* Screen will appear. Repeat steps 2-4 to start a second scan.

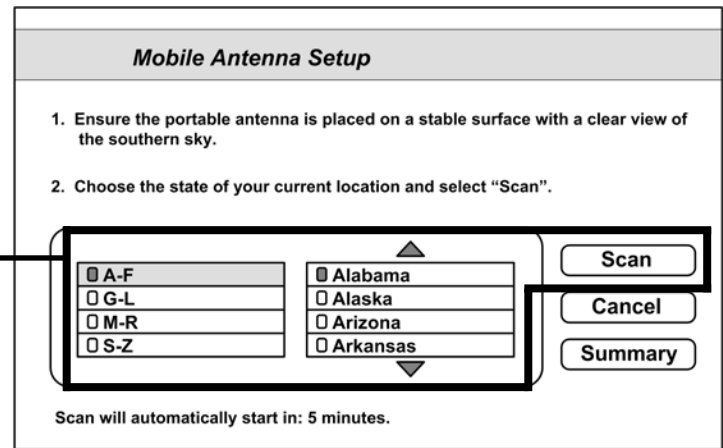

The unit will scan a second time.

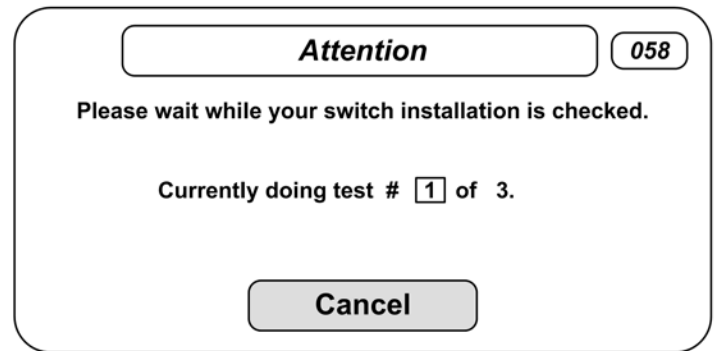

When the scan is complete, the *Acquiring Signal* message will display. Acquiring the signal may take up to 5 minutes to complete.

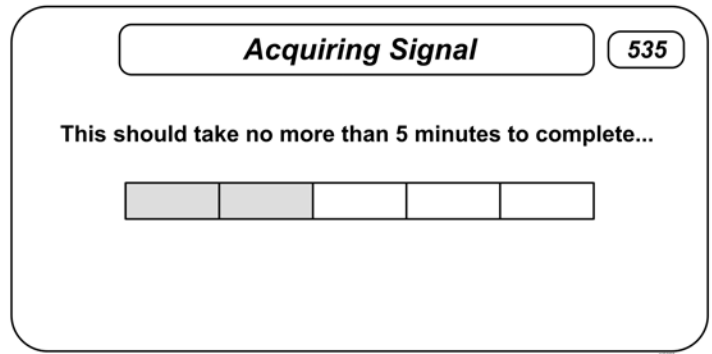

- 6. After your receiver has acquired the signal, it is ready to be activated. To activate service call 1-800-963-DISH (3474).



After your receiver is activated, the electronic program guide will download. This may take up to 10 minutes to complete (potentially longer if an external hard drive is connected).

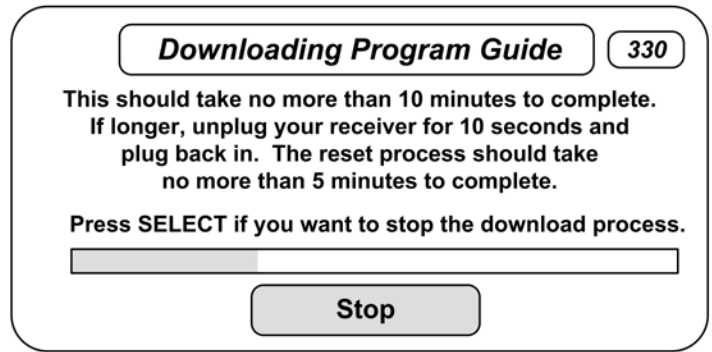

This completes the setup for new receivers. You may now use STANDARD KING TAILGATER OPERATION starting on the next page for subsequent use.

STANDARD KING TAILGATER OPERATION



IF YOUR RECEIVER IS NEW AND UNACTIVATED, YOU MUST COMPLETE THE STEPS ON PAGES 6-9 FIRST!

After connecting and turning on your equipment as instructed in **KING TAILGATER SETUP**, the *Mobile Antenna Setup* screen will display. (It may take up to two minutes to display.)

Note: If the *Mobile Antenna Setup* screen does not display, press MENU, 6, 1, 1 on your remote. Highlight the “Check Switch” button then press SELECT on your remote.

Mobile Antenna Setup

1. Ensure the portable antenna is placed on a stable surface with a clear view of the southern sky.
2. Choose the state of your current location and select “Scan”.

<input checked="" type="radio"/> A-F	<input checked="" type="radio"/> Alabama
<input type="radio"/> G-L	<input type="radio"/> Alaska
<input type="radio"/> M-R	<input type="radio"/> Arizona
<input type="radio"/> S-Z	<input type="radio"/> Arkansas

Scan will automatically start in: 5 minutes.



IN STEPS 1-5, DO NOT BLOCK THE KING TAILGATER’S LINE OF SIGHT TO THE SATELLITES IN THE SOUTHERN SKY AT ANY TIME!

SATELLITES IN SOUTHERN SKY



Point handle north to speed up search time

OBSTRUCTIONS

ANTENNA UNIT

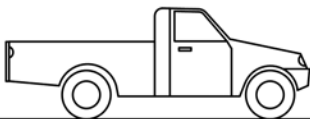

IMPORTANT!
If you move the antenna unit any time during or after the scan, you will have to repeat steps 1-5.

1. Use the arrow buttons on your remote to highlight the letter group that includes the first letter of the state you are currently in.

Press SELECT on your remote.

Mobile Antenna Setup

1. Ensure the portable antenna is placed on a stable surface with a clear view of the southern sky.
2. Choose the state of your current location and select “Scan”.

<input checked="" type="radio"/> A-F	<input checked="" type="radio"/> Alabama
<input type="radio"/> G-L	<input type="radio"/> Alaska
<input type="radio"/> M-R	<input type="radio"/> Arizona
<input type="radio"/> S-Z	<input type="radio"/> Arkansas

Scan will automatically start in: 5 minutes.

2. Highlight the state you are currently in from the state menu.

Press SELECT.

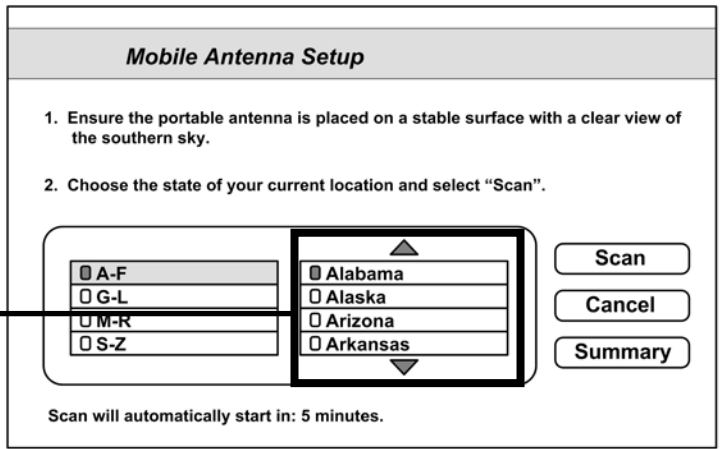

3. Verify Scan is highlighted.

Press SELECT.

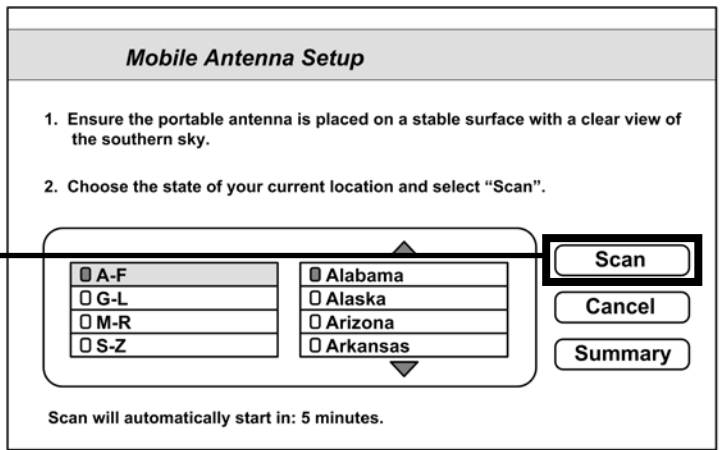

The scan will begin and may take up to several minutes to complete.

This screen will display during the scan.

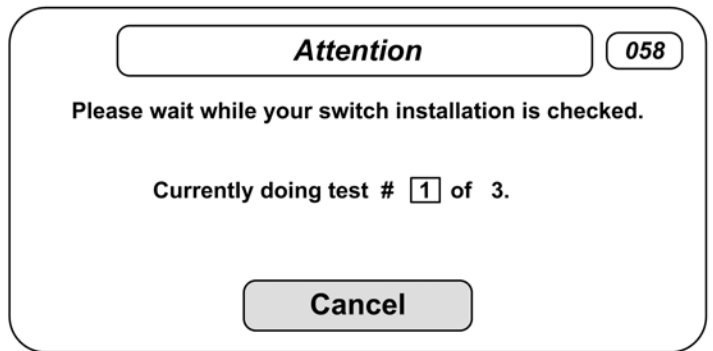

4. When the scan is complete, the *Acquiring Signal* message will display. Acquiring the signal may take up to 5 minutes to complete.

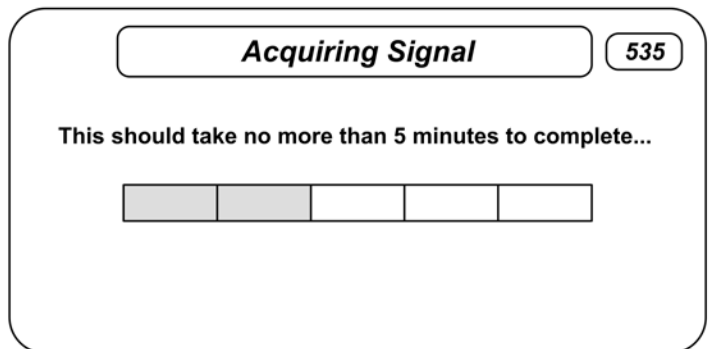

5. After your receiver has acquired the signal, the electronic program guide will download. This may take up to 10 minutes to complete (potentially longer if an external hard drive is connected).

Downloading Program Guide 330

This should take no more than 10 minutes to complete. If longer, unplug your receiver for 10 seconds and plug back in. The reset process should take no more than 5 minutes to complete.

Press SELECT if you want to stop the download process.

Stop



If your receiver has not been used for awhile the 013 error message may appear. Call 1-800-333-DISH (3474) and follow the prompts to reauthorize your receiver. Note that if channel 101 appears, scroll channel up or down to make sure 013 error message does not appear.

You can view your programming when your receiver has been authorized and the guide has finished downloading.

OPERATING NOTES:



IF YOU MOVE THE KING TAILGATER, YOU WILL HAVE TO REPEAT STEPS 1-5 TO REACQUIRE THE SATELLITES AND RESTORE PROGRAMMING.

When in the northeastern United States, television programming from the 129 satellite may not be available (see page 4).

If your system is inactive for an extended period of time, you may have to call DISH Customer Service at 1-800-333-DISH (3474) to reauthorize your receiver.

This page intentionally left blank.

SECOND RECEIVER OPERATION

INITIAL SETUP FOR SECOND RECEIVER

1. With the antenna locked on the satellite and the second receiver connected to the antenna unit's AUX port coax, use your DISH remote control and press **MENU, 6, 1, 1** to display the *Point Dish* screen.

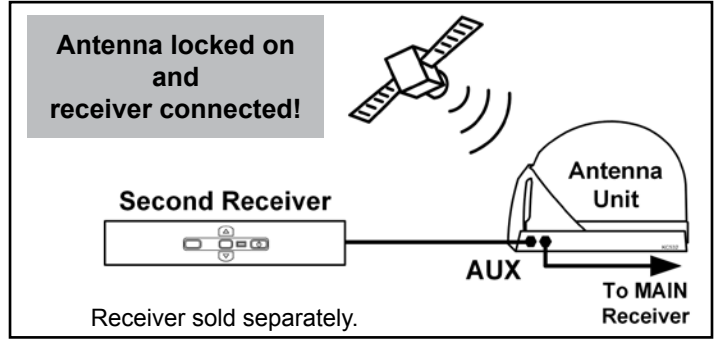

2. Use the arrow buttons on the remote to highlight Check Switch. Press SELECT on your remote.

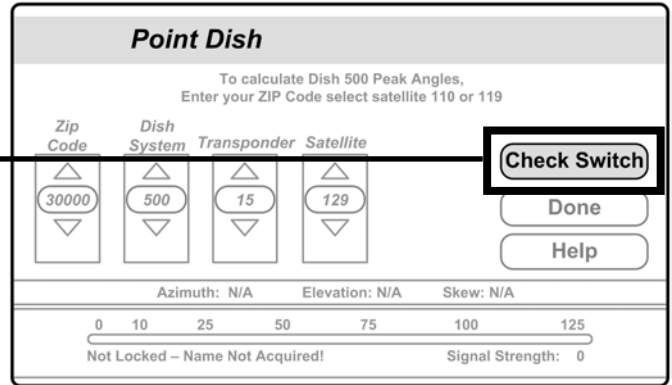

3. Verify SuperDISH and Alternate are not selected. Verify Test is highlighted.

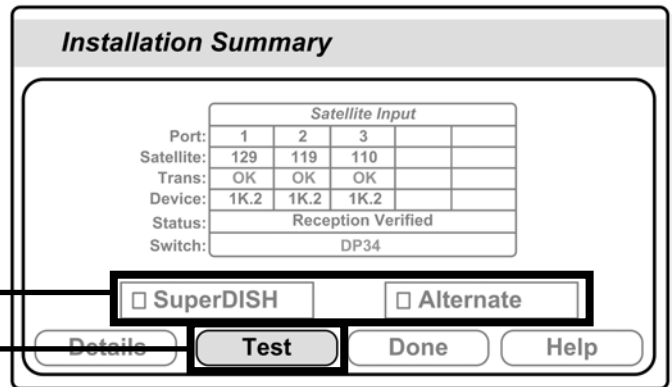

Press SELECT on your remote.

4. When test is complete, highlight Save.

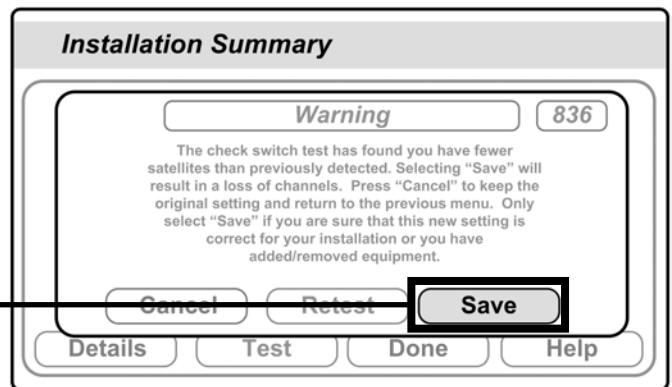

Press SELECT on your remote.

See the next page for downloading programming to the second receiver.

DOWNLOADING PROGRAMMING TO THE SECOND RECEIVER

After completing the steps on the previous page, reset the second receiver by pressing the POWER button on the front panel for 10 seconds. The TV picture will go away and should reappear within two minutes.

The receiver will then download the program guide to show only the channels available on the current satellite as determined by the channel selected on the main receiver. Downloading the new program guide can take up to five minutes to complete.

The channels available on the second receiver are determined by the channel/satellite selected on the main receiver. For example, if you select a channel on the main receiver that is broadcast from the 119 satellite, then the second receiver will be able to view any channel broadcast from the 119 satellite.

If you switch channels on the main receiver to one that is broadcast from a different satellite, (for example, your channel was broadcast from satellite 119 but your new channel is broadcast from the 110), the antenna will automatically switch to the 110 satellite and programming will be lost on the second receiver until you either:

- Select a channel on the main receiver that is broadcast from the previous satellite (satellite 119 in this example).
- (or)
- Reset the second receiver by following INITIAL SETUP FOR SECOND RECEIVER (on previous page) to download the program guide for the newly selected satellite (satellite 110 in this example).

NOTE: If you choose a channel on the main TV that causes the antenna to switch satellites, you may have to run a check switch on the second receiver.

PROPER CARE OF YOUR EQUIPMENT

1. Always handle the KING Tailgater product carefully. Do not drop the KING Tailgater. Avoid excessive shock or vibration to the KING Tailgater.
2. Use caution when carrying the KING Tailgater. Always carry the KING Tailgater by the handle.
3. Do not remove the cover of the KING Tailgater without authorization. Doing so will void the Limited Warranty.
4. Do not stack the KING Tailgater on top of or below other electronic devices as this can cause heat build-up or block the satellite signal from reaching the KING Tailgater.
5. Never power wash the KING Tailgater. Keep the enclosure clean from dirt, bugs, and other debris by hand washing with mild soap and water.
6. Do not coat or paint the KING Tailgater with any substance. (KING **Dome Magic**® may be applied to the KING Tailgater to help keep snow and rain from building up on the surface.)

The KING Tailgater has been designed to be maintenance and trouble free. If not using the KING Tailgater for long periods of time, it is recommended that you set up the system on a quarterly basis (every three months) to keep all moving parts of the KING Tailgater in good working order.

If you have any comments or questions, please contact the KING Service Department at (952) 345-8147, or by email at help@kingconnect.com.

SECURITY

The KING Tailgater can be secured to an object by looping a cable thru the handle.

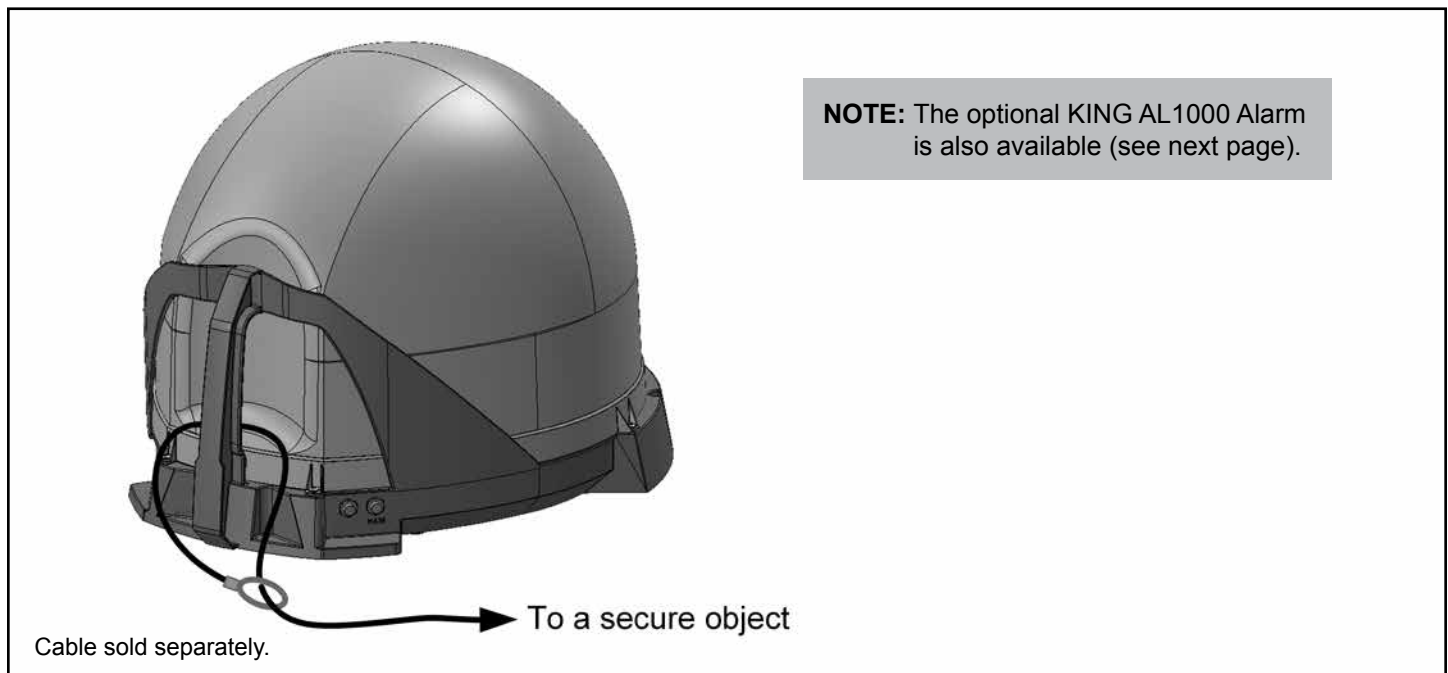

KING AL1000 ALARM

The KING AL1000 Alarm goes in-line between your main powered receiver and the KING Tailgater. It will sound an audible security alarm if the coax is disconnected from the KING Tailgater.

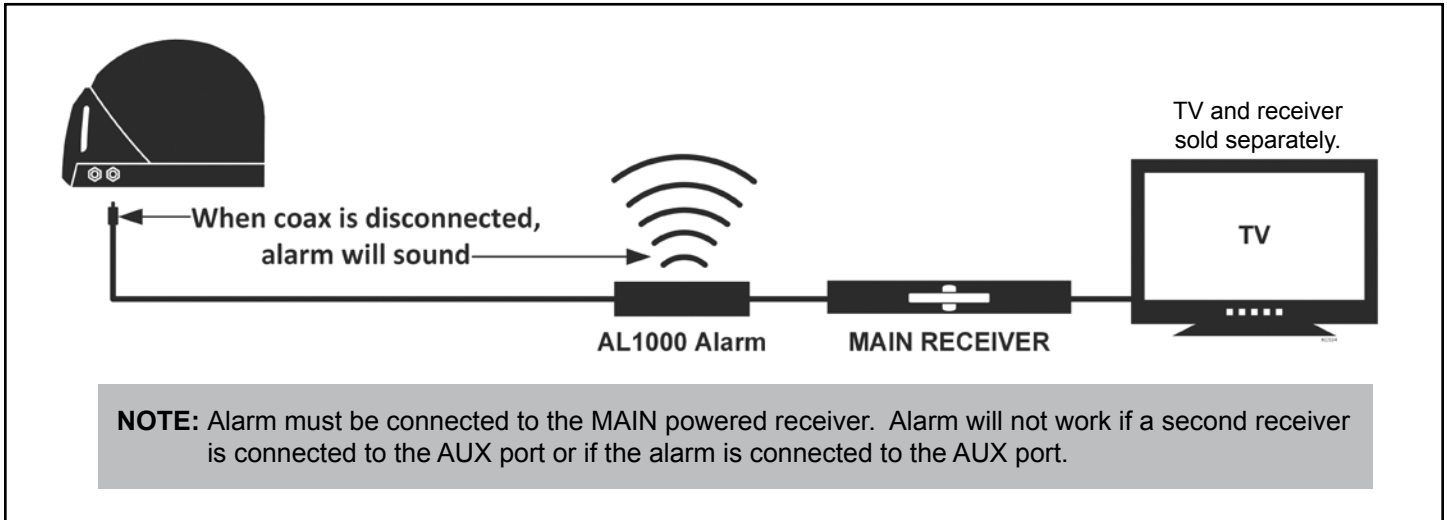

KING MB150 MOUNTING BRACKET

The KING Tailgater can be permanently mounted to a vehicle using the MB150 Mounting Bracket.

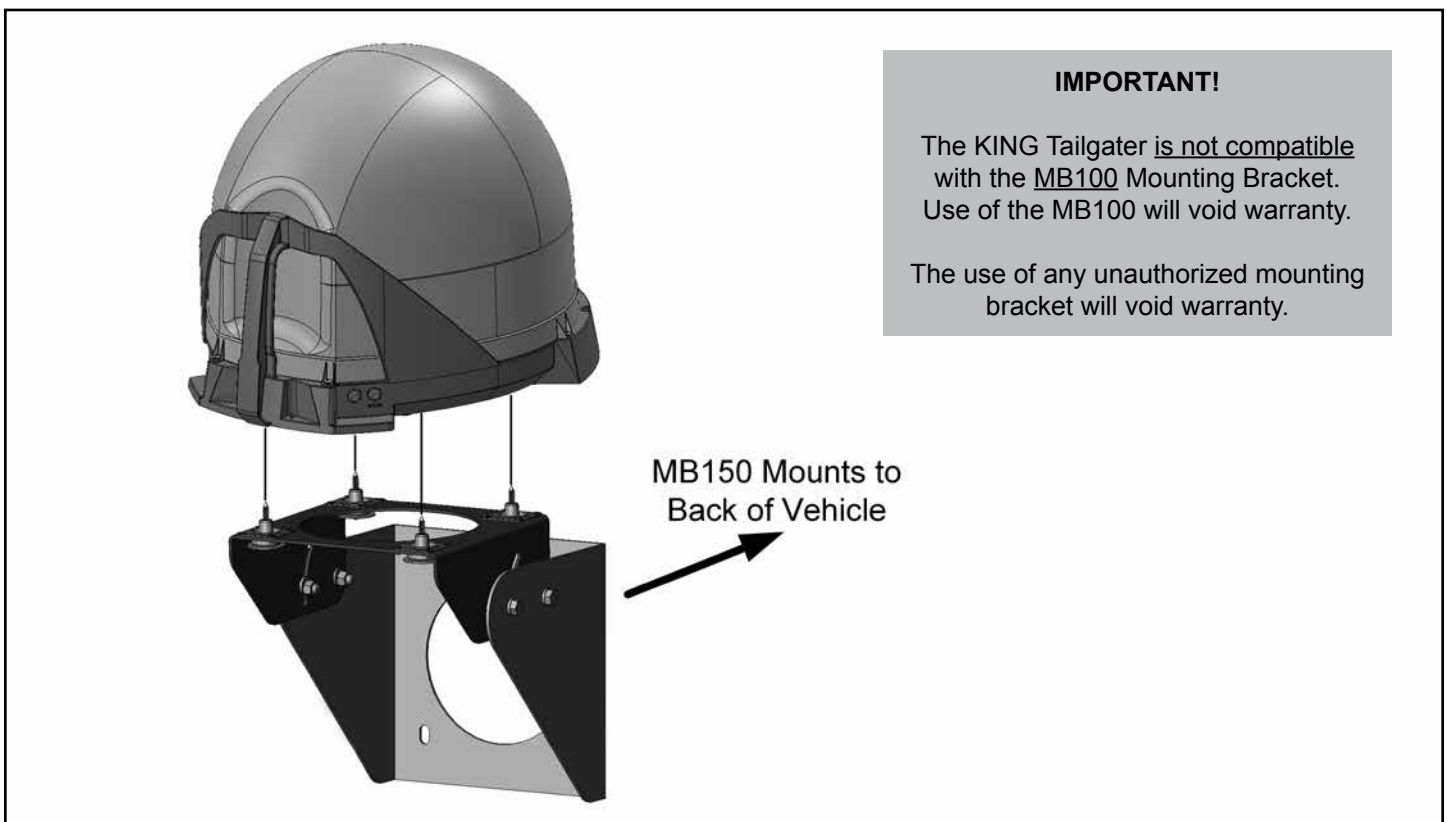

ROOF INSTALLATION

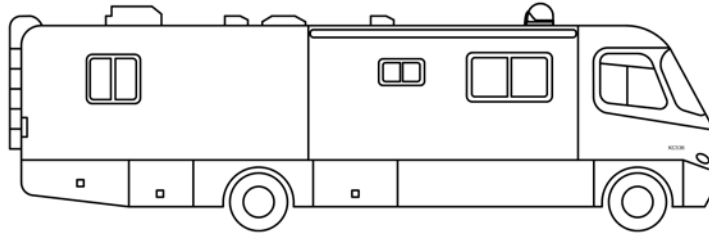

1. Make sure you have the following tools and materials before starting.

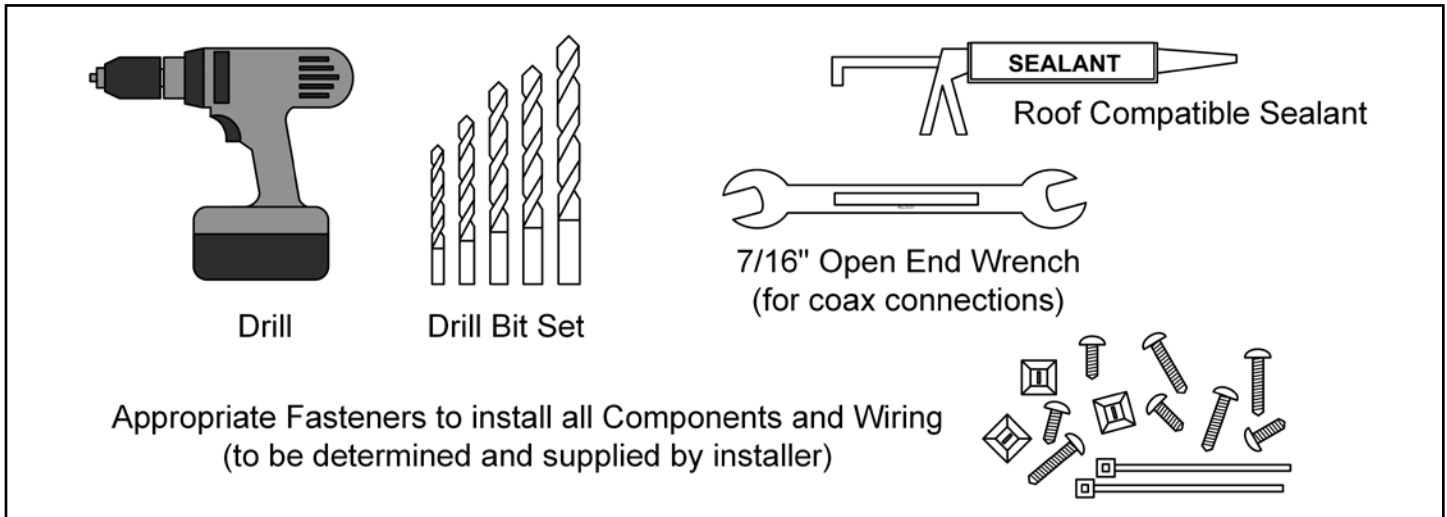

NOTE: Many RVs are prewired with RG-6 coax cable for satellite antennas. Contact the manufacturer of your RV or your local dealer to verify where this cable is located.

If prewired, run the existing coax cable from the prewire location in the roof to the antenna unit. When choosing the antenna unit location, make sure the prewiring will reach the antenna unit.

ANTENNA UNIT LOCATION (See Illustration on next page)

2. Select an area on the roof for the antenna unit and the location where the wiring will enter the vehicle through the roof to the satellite receiver inside using the following criteria:
 - A shorter distance between the antenna unit and the satellite receiver is most desirable.
 - Make sure you have enough room to mount the antenna unit.
 - The antenna unit should be mounted on the center line of the vehicle, and not tilted more than 2 degrees in any direction.
 - There must be no “line of sight” obstructions. Air conditioning units, other antennas, and storage areas that are too close to the antenna unit may prevent the satellite signal from reaching the antenna unit.
 - Mount the antenna unit with the handle to rear of the vehicle.

ANTENNA UNIT LOCATION

HEIGHT OF OBSTRUCTION	APPROXIMATE MINIMUM DISTANCE TO EDGE OF ANTENNA UNIT
10"	8"
11"	10"
12"	12"
13"	14"
14"	16"
15"	18"
16"	20"

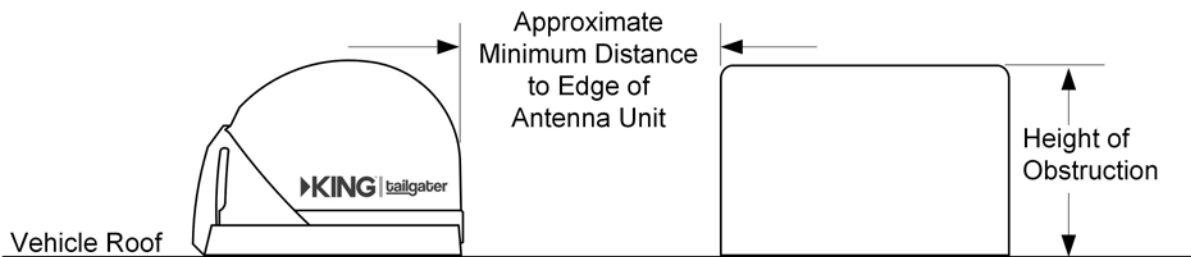

Do not mount antenna unit too close to obstructions.

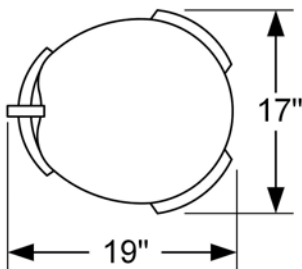

Choose a location with adequate space.

Mount antenna unit on center line of vehicle.

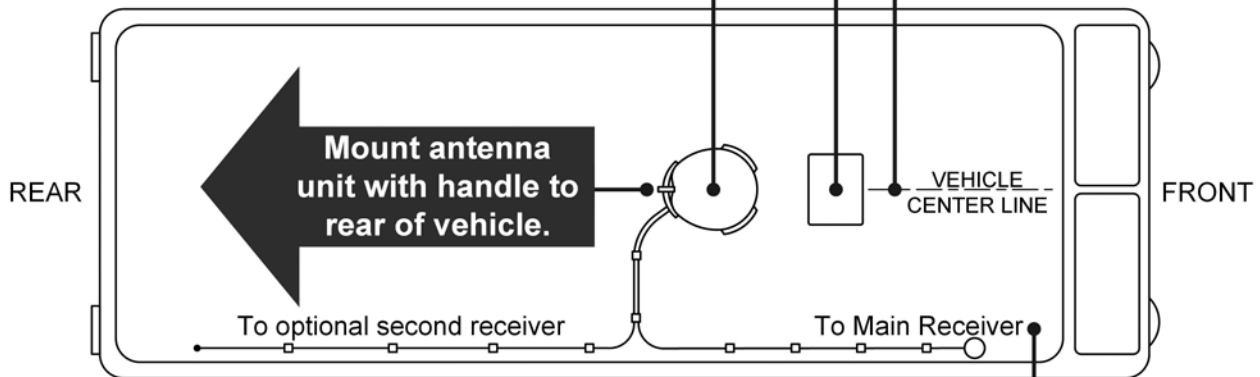

Try to install antenna unit as close as possible to main receiver to minimize coax length.

NOTE: The installer is responsible for determining the most appropriate fasteners to secure the antenna unit to the roof. Depending on the roof material, fasteners such as lag screws, well nuts, sheet metal screws, toggle bolts and T anchors may be used, and should always be used in combination with a roof compatible sealant.

IMPORTANT! The installer is responsible for weatherproofing all holes with sealant.

- If the rubber feet have been installed, lay the unit on a soft, non-scratching surface and remove them from the bottom of the unit.
DO NOT INSTALL UNIT WITH RUBBER FEET IN PLACE.

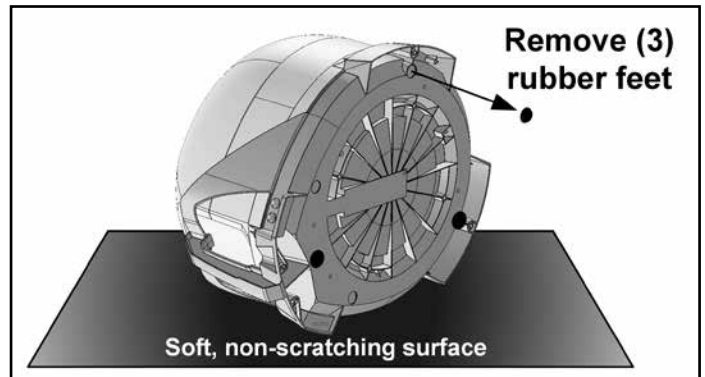

IMPORTANT!
For roof mounting, do not apply the rubber feet.
If present, remove rubber feet.
MOUNTING WITH RUBBER FEET VOIDS WARRANTY.

- Mount the antenna unit using the (4) mounting holes. Make sure to seal mounting holes with roof compatible sealant.

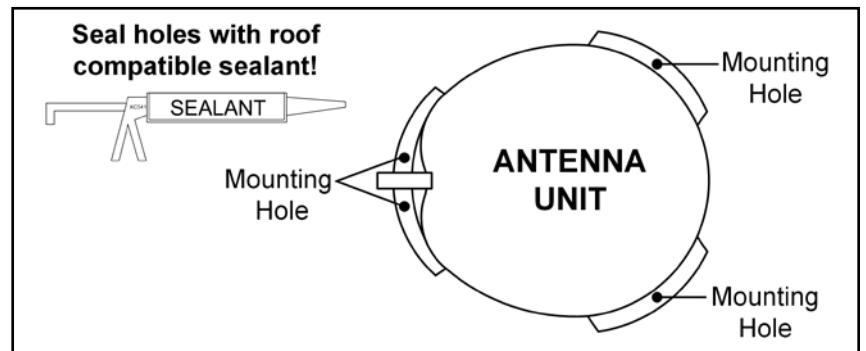

NOTE: There are two coax ports on the back of the antenna unit. The one labeled “MAIN” **MUST** be connected to the main receiver in vehicle. This is the receiver that will control automatic satellite switching. The one labeled “AUX” can be used for an additional receiver if desired.

- Connect one end of 50 foot coax cable to the MAIN port and tighten connection (see below).
DO NOT OVER TIGHTEN.

If using a second receiver, connect end of second coax (sold separately) to the AUX port. Tighten connection. **DO NOT OVER TIGHTEN.**

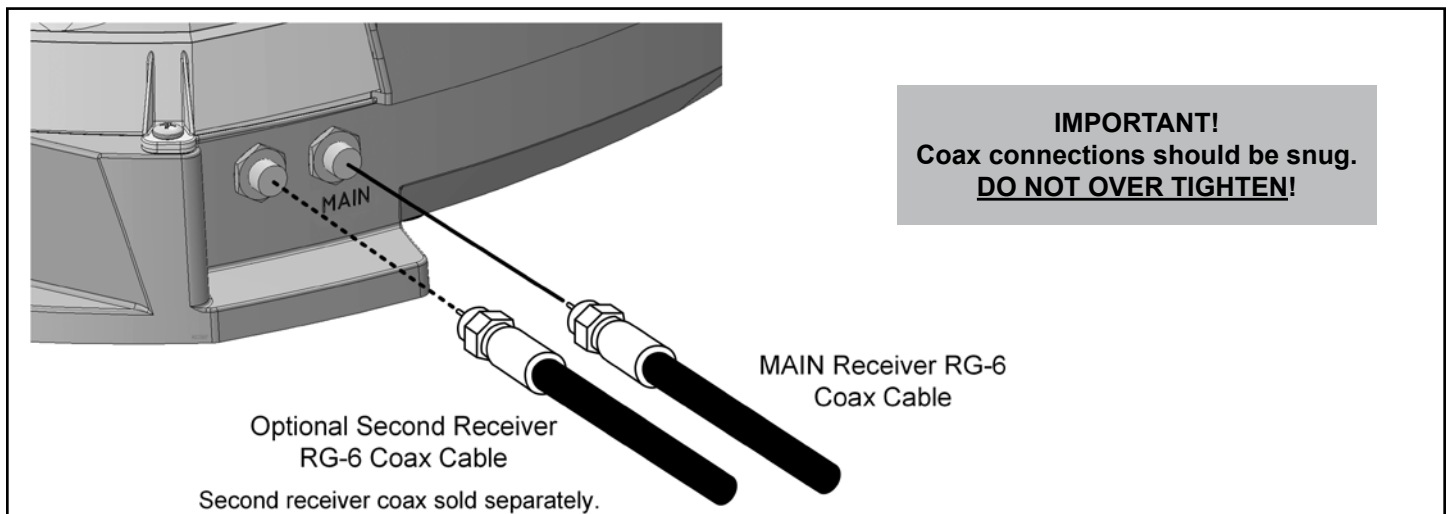

AVOID SHARP BENDS WHEN ROUTING COAX!

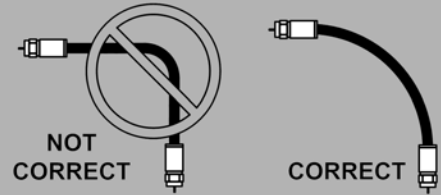

- Run coax from the antenna unit to the roof edge, then along edge to location where coax will be fed into the vehicle. If installing an optional second receiver, run second coax to location where it will enter the vehicle. Secure (both) coax to roof every 12-18 inches (see below).
- Drill 3/4" hole through the roof and into the cabinet where receiver is stored. Feed coax down through hole. Seal opening with roof compatible sealant so that it is completely waterproof (inside and outside of the 3/4" hole). Repeat for second coax if present.

TYPICAL ROOF INSTALLATION – OVERHEAD VIEW

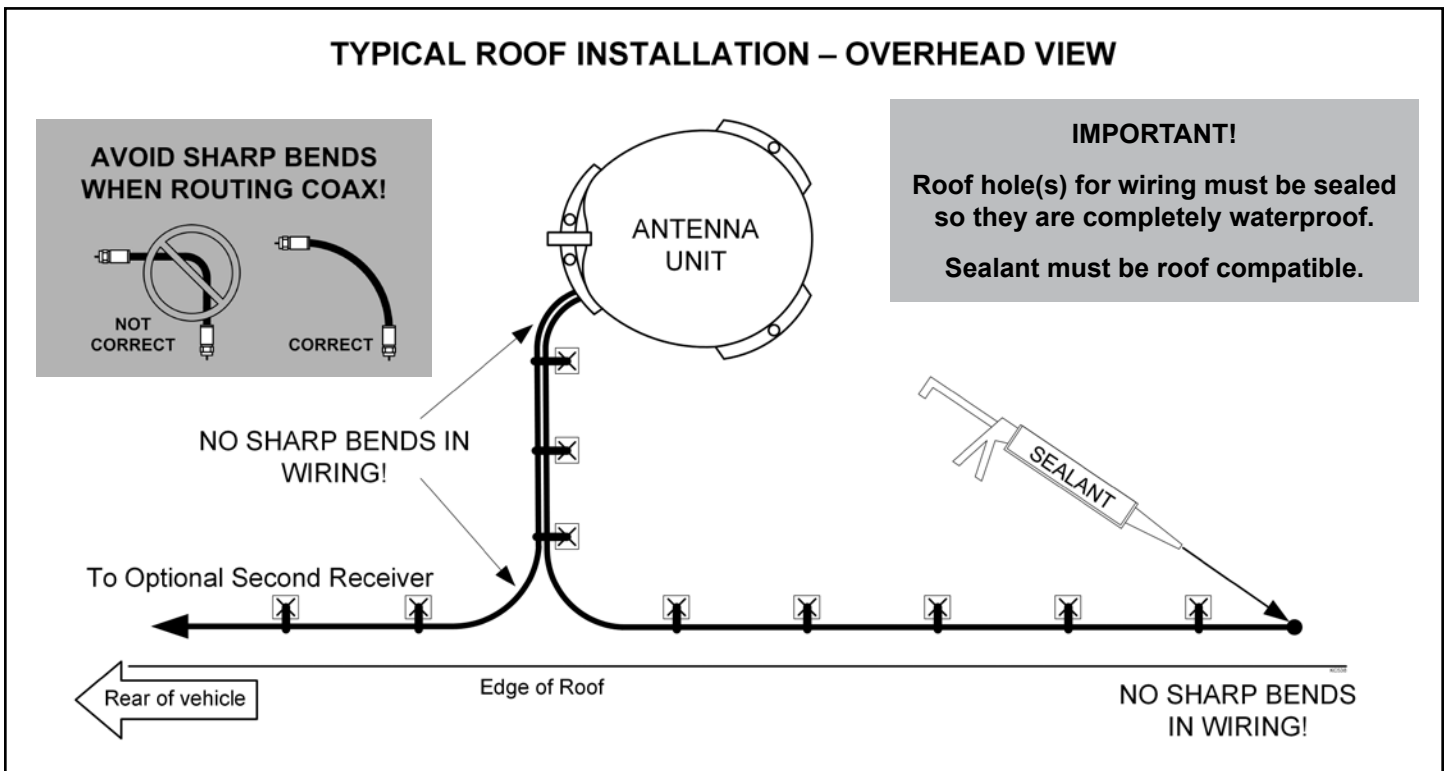

- Inside vehicle, connect coax cable(s) to the appropriate receiver(s).

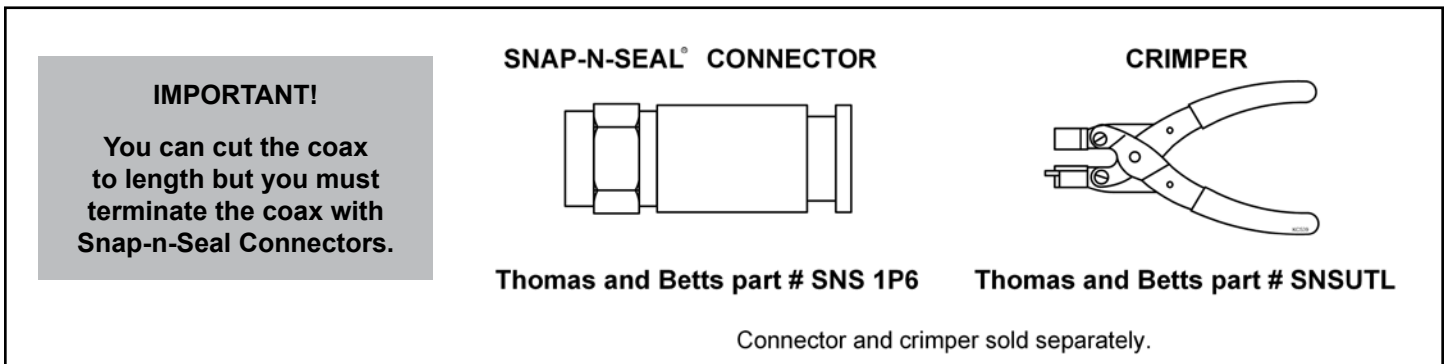

- Go to KING TAILGATER OPERATION Section.

TROUBLESHOOTING

Symptom/Message	Possible Cause	Troubleshooting
Receiver is stuck on "SYSTEM INFO" screen.	Access card is not fully seated in receiver slot.	Fully insert access card in receiver slot. On a ViP211z, this is located behind the front panel access door on left side of receiver.
Complete Signal Loss - 015	<p>Obstructions to the KING Tailgater's view of the southern sky, such as tree branches, severe rain, etc.</p> <p>Coax cable not connected properly between your receiver and the KING Tailgater.</p> <p>You have selected a local channel but are outside of its spot beam area.</p> <p>KING Tailgater has been moved.</p>	<ol style="list-style-type: none"> 1) Make sure nothing is blocking the KING Tailgater's view of the southern sky, such as tree branches, severe rain, or other obstructions. 2) Check that the coax cable between your receiver and the KING Tailgater is connected properly and hand tightened. 3) Unplug the power cord of your receiver for 10 seconds and plug it back in. It may take up to 5 minutes for your receiver to power back on. 4) Verify you have selected a nationally broadcast channel (CNN, ESPN, etc.). <p>If KING Tailgater has been moved, initiate a new scan.</p>
No Satellites Found - 151	<p>Obstructions to the KING Tailgater's view of the southern sky, such as tree branches, severe rain, etc.</p> <p>Coax cable not connected properly between your receiver and the KING Tailgater.</p>	<ol style="list-style-type: none"> 1) Make sure nothing is blocking the KING Tailgater's view of the southern sky, such as tree branches, severe rain, or other obstructions. 2) Check that the coax cable between your receiver and the KING Tailgater is connected properly and hand tightened. 3) Unplug the power cord of your receiver for 10 seconds and plug it back in. It may take up to 5 minutes for your receiver to power back on.
Partial Signal Loss - 002	Obstructions to the KING Tailgater's view of the southern sky, such as tree branches, severe rain, etc.	<ol style="list-style-type: none"> 1) Make sure nothing is blocking the KING Tailgater's view of the southern sky, such as tree branches, severe rain, or other obstructions. 2) Check that the coax cable between your receiver and the KING Tailgater is connected properly and hand tightened. 3) Try changing the channels to see if you are able to view live video. 4) Unplug the power cord of your receiver for 10 seconds and plug it back in. It may take up to 5 minutes for your receiver to power back on.

Symptom/Message	Possible Cause	Troubleshooting
My remote is not working.	<p>Your batteries may need to be replaced.</p> <p>Your remote is not currently paired with your receiver.</p> <p>Remote is in wrong mode.</p>	<ol style="list-style-type: none"> 1) Check to make sure the batteries are properly inserted in your remote. If the SAT button on top of the remote does not light up when you press it, replace the batteries. 2) Set up your remote control: <ul style="list-style-type: none"> • Press the “SYSTEM INFO” button on the front panel of your receiver. The “System Info” screen displays. • Press and release the SAT button on your remote control. • Press and release the RECORD button. You may see the remote address change on the screen. • Press and release the SELECT button on your remote to continue.
Channel Signal Loss - 004	KING Tailgater has not tracked to the appropriate orbital slot upon channel change.	<ol style="list-style-type: none"> 1) Unplug the power cord of your receiver for 10 seconds and plug it back in. It may take up to 5 minutes for your receiver to power back on. 2) On the Mobile Antenna Setup Screen: <ul style="list-style-type: none"> • Verify the correct state is selected. • Highlight “Scan” then press SELECT. • Once your system has found its satellites, it may take a few minutes to download the electronic program guide and acquire signal before live TV appears.
No Program Guide - 023	Your receiver has not yet acquired signal required to allow access to the electronic program guide.	<ol style="list-style-type: none"> 1) Unplug the power cord of your receiver for 10 seconds and plug it back in. It may take up to 5 minutes for your receiver to power back on. 2) On the Mobile Antenna Setup Screen: <ul style="list-style-type: none"> • Verify the correct state is selected. • Highlight “Scan” then press SELECT. • Once your system has found its satellites, it may take a few minutes to download the electronic program guide and acquire signal before live TV appears.
All Satellites Not Found - 150	<p>Obstructions to the KING Tailgater’s view of the southern sky, such as tree branches, severe rain, etc.</p> <p>Your physical location may be outside the footprint of the desired orbital slot.</p>	<ol style="list-style-type: none"> 1) Make sure nothing is blocking the KING Tailgater’s view of the southern sky, such as tree branches, severe rain, or other obstructions. 2) Unplug the power cord of your receiver for 10 seconds and plug it back in. It may take up to 5 minutes for your receiver to power back on.
Sporting Event Blackout - 744	Blackout patterns are applied based on the physical address on your account. Events outside the area surrounding your physical address may not be available.	N/A

Symptom/Message	Possible Cause	Troubleshooting
Over-the-Air Antenna Channels Missing - Error 739	<p>The quality of reception and number of channels available depends on, among other things, the over-the-air antenna's placement and your location.</p> <p>Weather conditions may interfere with channel reception.</p> <p>You are in a new location and have not scanned for channels.</p> <p>VIP211z receivers do not have an over-the-air tuner built in.</p>	<ol style="list-style-type: none"> 1) Check that the wiring between your DISH receiver and your over-the-air antenna is configured properly. 2) Unplug the power cord of your receiver for 10 seconds and plug it back in. It may take up to 5 minutes for your receiver to power back on. 3) Scan again for over-the-air antenna channels to your receiver: <ul style="list-style-type: none"> • Using the DISH remote, press MENU then 6-8 to access the local channels screen. • Select "Scan Locals." <p>DISH sells a separate over-the-air tuner. (DISH part number DISH-OTATUNER)</p>
Outside of Viewing Area - 120	Local channels may not be available if your receiver is not physically located at or near the address listed on your DISH account.	N/A
Local Channels Interrupted - 536	Local channels may not be available if your receiver is not physically located at or near the address listed on your DISH account.	N/A
Missing Channels.	<p>The electronic program guide may not be set to "My Channels."</p> <p>You may not have the orbital slots required to view the missing television programming.</p>	<ol style="list-style-type: none"> 1) Press the GUIDE button on your remote twice to display the "Favorites List Options" menu. Select "My Channels" using the arrow buttons on your remote. 2) Confirm that you subscribe to the missing channel by using dish.com/mychannels. 3) Perform a check switch test: <ul style="list-style-type: none"> • Using your DISH remote, press MENU then 6-1-1. Highlight the Check Switch Button then press SELECT. • Highlight "Scan" then press SELECT. • Once your system has found its satellites, it may take a few minutes to download the electronic program guide and acquire signal before live TV appears. 4) Unplug the power cord of your receiver for 10 seconds and plug it back in. It may take up to 5 minutes for your receiver to power back on.
Local Channels Missing.	Local channels may not be available if your receiver is not physically located at or near the address listed on your DISH account.	N/A

Symptom/Message	Possible Cause	Troubleshooting
Guide Information Not Available.	<p>Your receiver was not powered off at night to receive the nightly electronic program guide updates.</p> <p>Your receiver has not yet acquired signal needed to gain access to the electronic program guide.</p>	<ol style="list-style-type: none"> 1) Unplug the power cord of your receiver for 10 seconds and plug it back in. It may take up to 5 minutes for your receiver to power back on. 2) On the Mobile Antenna Setup Screen: <ul style="list-style-type: none"> • Verify the correct state is selected. • Highlight "Scan" then press SELECT. • Once your system has found its satellites, it may take a few minutes to download the electronic program guide and acquire signal before live TV appears.
Guide Time is Incorrect.	<p>The guide time may be incorrect if your receiver is not physically located at the address listed on your DISH account.</p> <p>The guide time will be incorrect if you are using the KING Tailgater in an area with a different time zone than the address listed on your DISH account.</p>	N/A
Video Pixels / Audio Pops.	<p>Obstructions to the KING Tailgater's view of the southern sky, such as tree branches, severe rain, etc.</p> <p>Your receiver's signal is low.</p>	<ol style="list-style-type: none"> 1) Make sure nothing is blocking the KING Tailgater's view of the southern sky, such as tree branches, severe rain, or other obstructions. 2) Unplug the power cord of your receiver for 10 seconds and plug it back in. It may take up to 5 minutes for your receiver to power back on. 3) Check that the coax cable between your receiver and the KING Tailgater is connected properly.
Programming Not Authorized - 005/013/014	<p>You may not be subscribed to the channels you are trying to view.</p> <p>Your receiver has been unplugged or not connected to signal for a significant period of time.</p>	<ol style="list-style-type: none"> 1) Confirm that you subscribe to this channel by using dish.com/mychannels. 2) Unplug the power cord of your receiver for 10 seconds and plug it back in. It may take up to 5 minutes for your receiver to power back on. 3) Call 800-333-DISH (3474), select TECH and then mention you need RV Tech Support. When prompted by the audio menu, enter the error number using your phone keypad and an activation command will be sent to your receiver.

MANUFACTURER'S LIMITED WARRANTY

Every new KING Tailgater Satellite System is thoroughly inspected and tested before leaving the factory, and is covered by the following two year parts and one year labor limited warranty from the date of original purchase:

- Two year parts warranty: The customer is not responsible for the cost of replacement parts if the original part is determined to be defective under the terms of the warranty. The customer is responsible for the cost of replacement parts after two years.
- One year labor warranty: The customer is not responsible for labor costs to repair unit if unit falls under the terms of the warranty. The customer is responsible for all labor costs after one year.

Only KING may perform warranty evaluations and repairs. Depending upon the problem, KING may authorize a dealer to perform the necessary repairs. Any warranty labor outside of that performed at the factory is not covered unless 1) the product has been installed by an authorized dealer/installer or OEM manufacturer and 2) the dealer/installer receives prior authorization to perform the repair.

Should any trouble develop during the warranty period, contact KING at (952) 922-6889. You must contact KING before the warranty period expires. The customer must supply proof of purchase (such as a dated sales receipt) when requesting warranty service. If the customer cannot supply proof of purchase, warranty period shall start 30 days after date of manufacture.

If it is determined that the unit needs to be returned to KING, customer must return COMPLETE product, freight prepaid, to: **KING, 11200 Hampshire Avenue South, Bloomington, MN 55438-2453.**

If inspection shows the trouble is caused by defective workmanship or material, KING will repair (or at its option, replace) without charge.

When returning product, KING will supply an RMA number (Return Merchandise Authorization). This number must be clearly written on the box. Failure to clearly write RMA number on box will result in delays in processing claim. Along with product, the customer should include in the box: his/her name, address, daytime phone number, proof of purchase and description of the problem.

This warranty does not cover installation and external wiring, or remanufactured units. This warranty does not cover damage caused by the use of a mounting bracket other than a KING mounting bracket designed for the product. This warranty is not transferable from the original owner.

Due to the expanding and changing TV market, KING cannot be held responsible for changes made to satellite services. Software updates to address such issues are not covered under warranty.

This warranty also does not apply where:

- The product has been abused, misused, improperly installed or improperly maintained.
- The product has been installed on a bracket that is not a KING bracket designed for the product.
- Repairs have been made or attempted by others that are not certified by KING to do such repairs.
- Repairs are required because of normal wear and tear.
- Alterations have been made to the product.
- The antenna unit has been opened without authorization.
- Damage has been caused by power washing.
- Circumstances beyond the control of KING cause the product to no longer operate correctly.
- Customer is not the original owner.

In no event shall KING be liable for any indirect, incidental, or consequential damages from the sale or use of the product. This disclaimer applies both during and after the term of the warranty.

KING disclaims liability for any implied warranties, including implied warranties of "merchantability" and "fitness for a specific purpose," after the two year term of this warranty.

This warranty gives you specific legal rights, and you may also have other rights, which vary from state to state. Some states do not allow the exclusion or limitation of incidental or consequential damages, so the above limitation or exclusion may not apply to you. Some states do not allow limitations on how long an implied warranty lasts, so the above limitation may not apply to you.

FCC GUIDELINES

This device complies with Part 15, sub-part B, of the FCC Rules. Operation is subject to the following two conditions:

- 1) This device must not cause harmful interference, and
- 2) This device must accept any interference received, including interference that may cause undesired operation.

NOTES:



11200 Hampshire Avenue South, Bloomington, MN 55438
PH 952.922.6889 || FAX 952.922.8424 || kingconnect.com