

**NTSC SYSTEM VCMS17B**

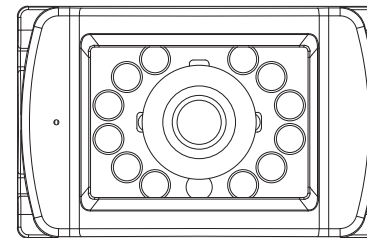







**VCMS17B Features:**

- High Performance CMOS Sensor
- IR LED Low Light Enhancement
- Waterproof (IPX6)
- Wide View Angle
- Audio microphone

ENGLISH

**Camera to bracket hardware**

Specifications	Q'ty
   Hex Socket Head M4 X 8L Stainless screws	4
  Flat washer 4.5 X 9.5 X 1mm Stainless	4
  Spring washer 6.6X4.0X1.0mm Stainless	4

Specifications	Q'ty
 Allen	1

**Installation**

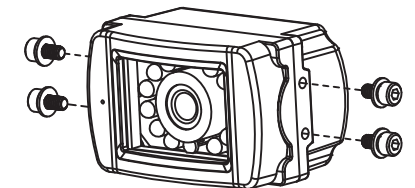

**Screw For Use**

Hex Socket Head M4 X 8L Stainless screws  
Stainless Allen wrench

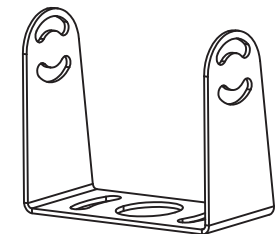

**Contents:**

- Camera
- Bracket
- Hardware Kit

**Installation and Pin Out:**

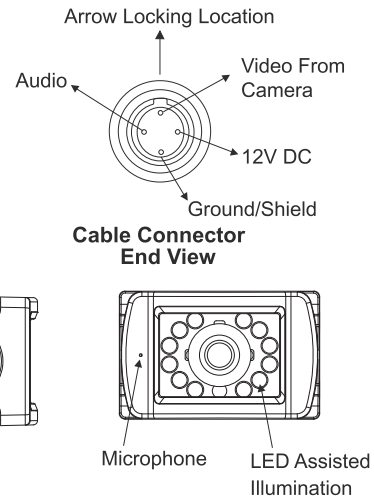
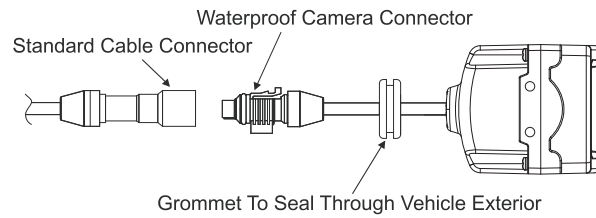

**Specifications**

Mounting Type	External type
Image sensor	1/3" CMOS camera
Resolution	600 TV lines
Min illumination	1.0 Lux at F2.0 0 Lux with IR on
Water resistance	IPX6
View angle	94.6(H), 68(V), 131(D)
Dimension	70(W) X 44.7(H) X 52.6(D)mm 2.76(W) X 1.76(H) X 2.07(D)Inch
Working temperature	-20 C ~ +70 C
Weight	Approx. 0.50kg / 0.84lbs

**Bracket Mtg. Hole Dimensions**

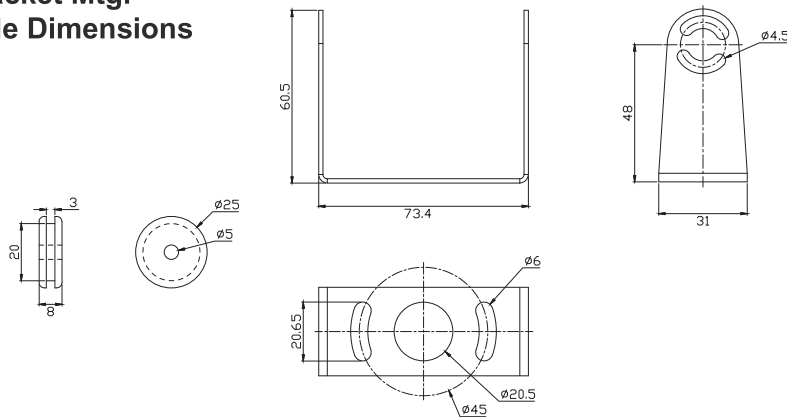

Unit: MM

**Recommended grommet Hole**

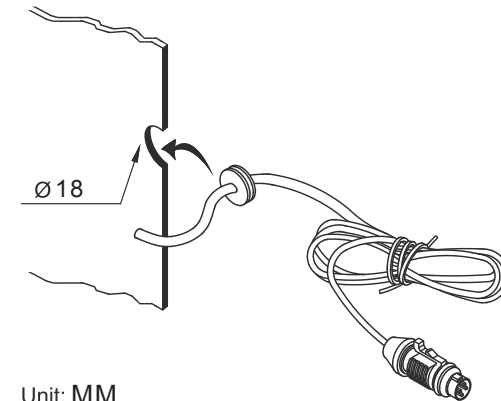

Unit: MM